

Kia, THE COMPANY



Thank you for becoming the owner of a new Kia vehicle.

As a global car manufacturer focused on building high-quality vehicles with exceptional value, Kia Motors is dedicated to providing you with a customer service experience that exceeds your expectations.

All information contained in this Owner's Manual is accurate at the time of publication. However, Kia reserves the right to make changes at any time so that our policy of continual product improvement can be carried out.

تلفن شبانه روزی: ۰۸۵-۰۸۷۶-۰۲۱

This manual applies to all models of this vehicle and includes descriptions and explanations of optional as well as standard equipment. As a result, you may encounter material in this manual that is not applicable to your specific Kia vehicle.

Drive safely and enjoy your Kia!

FOREWORD

Thank you for choosing a Kia vehicle.

When you require service, remember that your Kia dealer knows your vehicle best. Your dealer has factory-trained technicians, recommended special tools and genuine Kia replacement parts. It is dedicated to your complete customer satisfaction.

Because subsequent owners require this important information as well, this publication should remain with the vehicle if it is sold.

This manual will familiarize you with operational, maintenance and safety information about your new vehicle. It is supplemented by a Warranty and Consumer Information manual that provides important information on all warranties regarding your vehicle.

We urge you to read these publications carefully and follow the recommendations to help assure enjoyable and safe operation of your new vehicle.

Kia offers a great variety of options, components and features for its various models. Therefore, some of the equipment described in this manual, along with the various illustrations, may not be applicable to your particular vehicle.

The information and specifications provided in this manual were accurate at the time of printing. Kia reserves the right to discontinue or change specifications or design at any time without notice and without incurring any obligation. If you have questions, always check with your Kia dealer.

We assure you of our continuing interest in your motoring pleasure and satisfaction in your Kia vehicle.

© 2013 Kia Canada Inc.

All rights reserved. Reproduction by any means, electronic or mechanical, including photocopying, recording, or by any information storage and retrieval system or translation in whole or part is not permitted without written authorization from Kia Canada Inc..

Printed in Korea

امداد خودرو فارما

تلفن شبانه روزی: ۰۸۵-۸۸۶۲۰۳۱

FarmaSC

TABLE OF CONTENTS

Introduction

How to use this manual / Fuel requirements / Vehicle break-in process

1

Your vehicle at a glance

Exterior overview / Interior overview / Instrument panel overview / Engine compartment

2

Safety features of your vehicle

Seats / Seat belts / Child restraint system / Air bag

3

Features of your vehicle

Keys / Door locks / Tailgate / Windows / Hood / Fuel filler lid / Panoramic sunroof / Steering wheel / Mirrors / Instrument cluster / Lighting / Wipers & Washers / Climate control system / Audio system / Etc.

4

Driving your vehicle

Before driving / Engine start/stop button / Transaxle / Brake system / Cruise control system / Active ECO system / Winter driving / Vehicle load limit / Etc.

5

What to do in an emergency

Road warning / Emergency while driving / Emergency starting / Engine overheat / Flat tire / Towing / Etc.

6

Maintenance

Engine compartment / Maintenance service / Engine oil / Engine coolant / Brake fluid / Washer fluid / Parking brake / Air cleaner / Wiper blades / Battery / Tire and wheels / Fuses / Etc.

7

Specifications & Consumer information

8

Index

1

Introduction

How to use this manual	1-2
Fuel requirements	1-3
• Gasoline containing alcohol and methanol.....	1-3
• Do not use methanol	1-4
• Fuel Additives	1-4
Vehicle Break-In Process.....	1-5

امداد خودرو فارما

تلفن شبانه روزی: ۰۲۱-۸۸۸۶۲۰۸۵

FarmaSOS.com

HOW TO USE THIS MANUAL

We want to help you get the greatest possible driving pleasure from your vehicle. Your Owner's Manual can assist you in many ways. We strongly recommend that you read the entire manual. In order to minimize the chance of death or injury, you must read the WARNING and CAUTION sections in the manual.

Illustrations complement the words in this manual to best explain how to enjoy your vehicle. By reading your manual, you will learn about features, important safety information, and driving tips under various road conditions.

The general layout of the manual is provided in the Table of Contents. Use the index when looking for a specific area or subject; it has an alphabetical listing of all located in the back of this manual.

Sections: This manual has eight sections plus an index. Each section begins with a brief list of contents so you can tell at a glance if that section has the information you want.

You will find various types of safety instructions in this manual. These instructions were prepared to enhance your personal safety.

Carefully read and follow ALL procedures and recommendations provided in these instructions.

WARNING

A WARNING indicates a situation in which harm, serious bodily injury or death could result if the warning is ignored.

CAUTION

A CAUTION indicates a situation in which damage to your vehicle could result if the caution is ignored.

*** NOTICE**

A NOTICE indicates interesting or helpful information is being provided.

تلفن شبانه روزی: ۰۲۱-۸۸۸۶۲۰۸۵

FarmaSOS.com

FUEL REQUIREMENTS

Your new Kia vehicle is designed to use only unleaded fuel having a pump octane number ((R+M)/2) of 87 (Research Octane Number 91) or higher.

Your new vehicle is designed to obtain maximum performance with UNLEADED FUEL, as well as minimize exhaust emissions and spark plug fouling.

Never add any fuel system cleaning agents to the fuel tank other than what has been specified. (Consult an authorized Kia dealer for details.)

WARNING - Refueling

- **Do not "top off" after the nozzle automatically shuts off. Attempts to force more fuel into the tank can cause fuel overflow onto you and the ground causing a risk of fire.**
- **Always check that the fuel cap is installed securely to prevent fuel spillage, especially in the event of an accident.**

*** NOTICE**

Tighten the cap until it clicks once, otherwise the Check Engine  light will illuminate.

FarmaSOS.com

Gasoline containing alcohol and methanol

Gasohol, a mixture of gasoline and ethanol (also known as grain alcohol), and gasoline or gasohol containing methanol (also known as wood alcohol) are being marketed along with or instead of leaded or unleaded gasoline.

Pursuant to EPA regulations, ethanol may be used in your vehicle. Do not use gasohol containing more than 10% ethanol, and do not use gasoline or gasohol containing any methanol. Ethanol provides less energy than gasoline and it attracts water, and it is thus likely to reduce your fuel efficiency and could lower your MPG results. Methanol may cause drivability problems and damage to the fuel system. Discontinue using gasohol of any kind if drivability problems occur. Vehicle damage or drivability problems may not be covered by the manufacturer's warranty if they result from the use of:

1. Gasoline or gasohol containing methanol.
2. Leaded fuel or leaded gasohol.

"E85" fuel is an alternative fuel comprised of 85 percent ethanol and 15 percent gasoline, and is manufactured exclusively for use in Flexible Fuel Vehicles. "E85" is not compatible with your vehicle. Use of "E85" may result in poor engine performance and damage to your vehicle's engine and fuel system. Kia recommends that customers do not use fuel with an ethanol content exceeding 10 percent.

* NOTICE

Your New Vehicle Limited Warranty does not cover damage to the fuel system or any performance problems caused by the use of "E85" fuel.

Use of MTBE

Kia recommends avoiding fuels containing MTBE (Methyl Tertiary Butyl Ether) over 15.0% vol. (Oxygen Content 2.7% weight) in your vehicle.

Fuel containing MTBE over 15.0% vol. (Oxygen Content 2.7% weight) may reduce vehicle performance and produce vapor lock or hard starting.

CAUTION

Your New Vehicle Limited Warranty may not cover damage to the fuel system and any performance problems that are caused by the use of fuels containing methanol or fuels containing MTBE (Methyl Tertiary Butyl Ether) over 15.0% vol. (Oxygen Content 2.7% weight.)

Do not use methanol

Fuels containing methanol (wood alcohol) should not be used in your vehicle. This type of fuel can reduce vehicle performance and damage components of the fuel system.

Fuel Additives

Kia recommends that you use good quality gasolines treated with detergent additives such as TOP TIER Detergent Gasoline, which helps prevent deposit formation in the engine. These gasolines will help the engine run cleaner and enhance performance of the Emission Control System. For more information on TOP TIER Detergent Gasoline, please go to the website (www.top-tiergas.com).

For Customers who do not use TOP TIER Detergent Gasoline regularly, and have problems starting or the engine does not run smoothly, additives that you can buy separately may be added to the gasoline. If TOP TIER Detergent Gasoline is not available, one bottle of additive added to the fuel tank at 12,000 km or every engine oil change is recommended. Additives are available from your authorized Kia dealer along with information on how to use them. Do not mix other additives.

Operation in foreign countries

If you are going to drive your vehicle in another country, be sure to:

- Observe all regulations regarding registration and insurance.
- Determine that acceptable fuel is available.

VEHICLE BREAK-IN PROCESS

No special break-in period is needed. By following a few simple precautions for the first 1,000 km (600 miles) you may add to the performance, economy and life of your vehicle.

- Do not race the engine.
- While driving, keep your engine speed (rpm, or revolutions per minute) between 2,000 rpm and 4,000 rpm.
- Do not maintain a single speed for long periods of time, either fast or slow. Varying engine speed is needed to properly break-in the engine.
- Avoid hard stops, except in emergencies, to allow the brakes to seat properly.
- Don't let the engine idle longer than 3 minutes at one time.
- Don't tow a trailer during the first 2,000 km (1,200 miles) of operation.

Your vehicle at a glance

Exterior overview	2-2
Interior overview	2-4
Instrument panel overview	2-5
Engine compartment	2-6

امداد خودرو فارما

تلفن شبانه روزی: ۰۲۱-۸۸۸۶۲۰۸۵

FarmaSOS.com

EXTERIOR OVERVIEW

■ Front view



- 1. Hood.....4-29
- 2. Head lamp.....4-95
- 3. Fog lamp4-95
- 4. Wheel and tire7-44
- 5. Outside rearview mirror.....4-48
- 6. Front windshield wiper blades4-99, 7-39
- 7. Windows.....4-24
- 8. Parking assist system4-86
- 9. Front removable towing hook.....6-23

* The actual shape may differ from the illustration.

OYDNIN3001

■ Rear view



- 10. Door locks4-18
- 11. Fuel filler lid.....4-31
- 12. Rear combination lamp
- 13. High mounted stop lamp
- 14. Trunk.....4-22
- 15. Antenna4-144
- 16. Parking assist system4-86

* The actual shape may differ from the illustration.

INTERIOR OVERVIEW

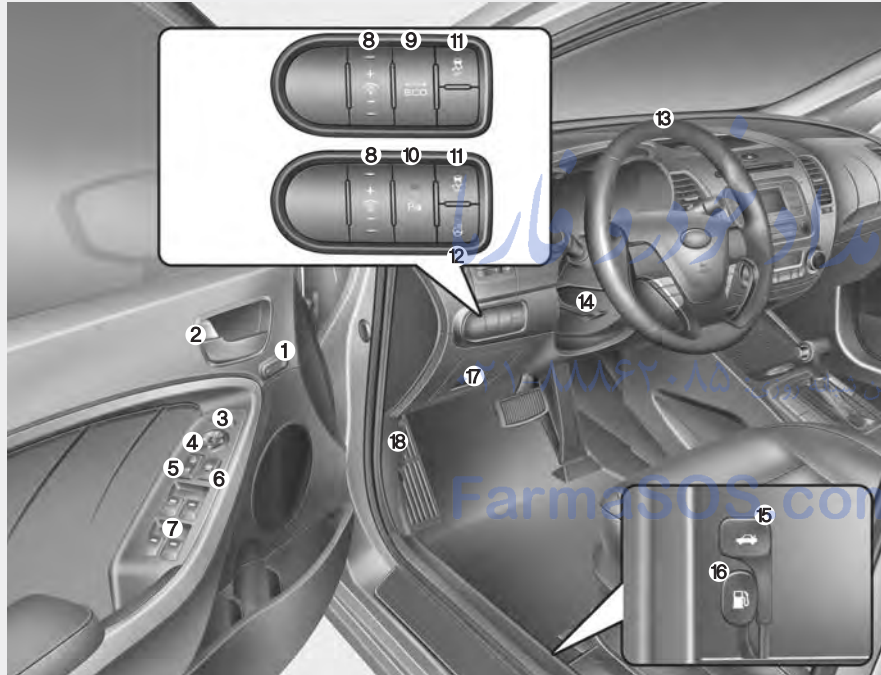

1. Driver position memory system button3-8
2. Inside door handle4-18
3. Outside rearview mirror folding.....4-50
4. Outside rearview mirror control4-49
5. Central door lock switch.....4-19
6. Power window lock switch.....4-27
7. Power window switch4-24
8. Instrument panel illumination control switch4-53
9. Active ECO On/Off switch.....5-40
10. Parking assist system On/Off button4-87
11. ESC Off button.....5-27
12. Heated steering wheel On/Off switch4-40
13. Steering wheel4-38
14. Tilt and telescopic steering control lever4-39
15. Trunk lid open lever4-22
16. Fuel filler lid open lever.....4-31
17. Inner fuse panel.....7-59
18. Hood release lever.....4-29

* The actual shape may differ from the illustration.

OYDNIN2003

INSTRUMENT PANEL OVERVIEW

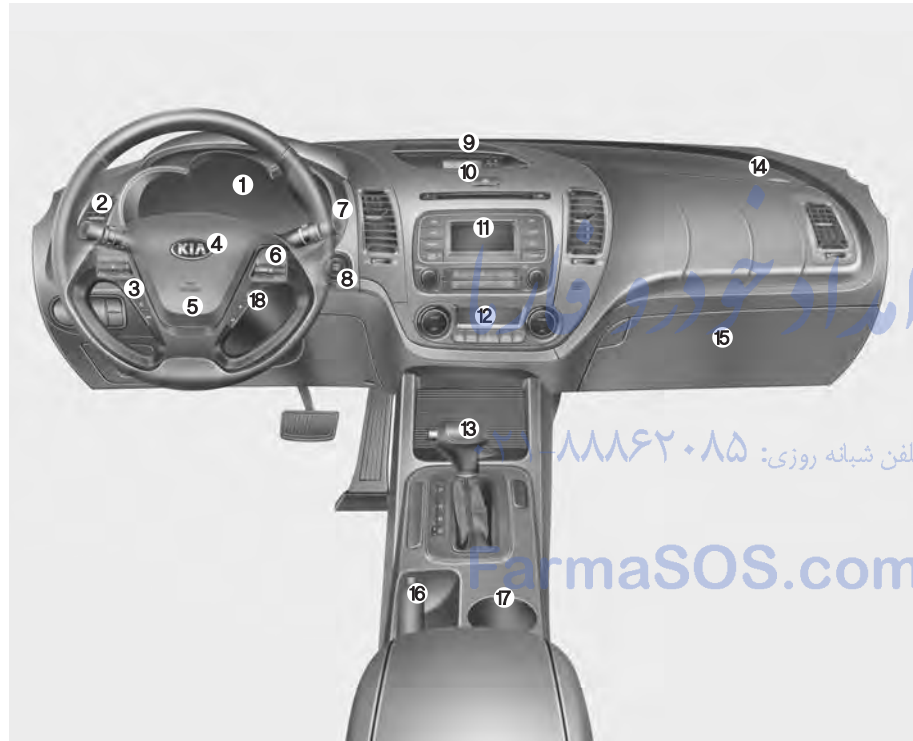

- 1. Instrument cluster4-52
- 2. Lighting control lever4-93
- 3. Audio remote control buttons4-145
- 4. Horn.....4-39
- 5. Driver's front air bag3-44
- 6. Cruise control button5-35
- 7. Wiper and washer control lever4-99
- 8. Ignition switch or
Engine start/stop button5-5, 5-7
- 9. Digital clock4-141
- 10. Hazard warning flasher6-2
- 11. Audio4-144
- 12. Climate control system.....4-107, 4-117
- 13. Shift lever5-13, 5-16
- 14. Passenger's front air bag3-44
- 15. Glove box4-132
- 16. Parking brake5-23
- 17. Cup holder.....4-136
- 18. LCD display control button4-54

* The actual shape may differ from the illustration.

OYDEIN2004CN

ENGINE COMPARTMENT

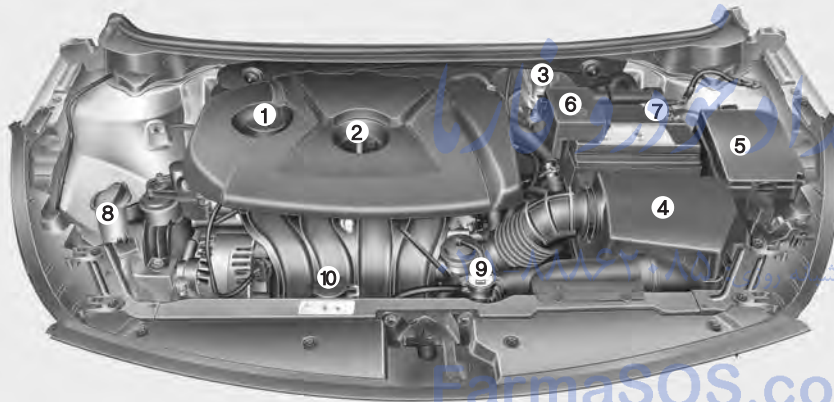

- 1. Engine oil filler cap7-29
- 2. Engine oil dipstick7-29
- 3. Brake/clutch fluid reservoir7-34
- 4. Air cleaner.....7-36
- 5. Fuse box7-58
- 6. Positive battery terminal7-41
- 7. Negative battery terminal.....7-41
- 8. Windshield washer fluid reservoir7-35
- 9. Radiator cap7-32
- 10. Engine coolant reservoir7-31

* The actual engine room in the vehicle may differ from the illustration.

OYDNMC2041

Safety features of your vehicle

Seat.....	3-2	• Occupant detection system.....	3-39
• Front seat adjustment - Manual	3-4	• Driver's and passenger's front air bag	3-44
• Front seat adjustment - Power.....	3-6	• Side air bag	3-47
• Driver position memory system.....	3-8	• Curtain air bag	3-48
• Headrest (Front seat)	3-10	• Inflation/non-inflation conditions of air bag	3-49
• Seatback pocket.....	3-11	• SRS Care	3-54
• Rear seat adjustment	3-11	• Air bag warning label	3-55
• Headrest (Rear seat)	3-11		
• Folding the rear seat	3-14		
Seat belt.....	3-16		
• Seat belt warning.....	3-17		
• Seat belt (3-point system)	3-17		
• Pre-tensioner seat belt.....	3-20		
• Seat belt precautions.....	3-23		
• Care of seat belts	3-25		
Child restraint system	3-26		
• Using a child restraint system	3-27		
• Tether Anchor system	3-30		
• Lower anchor system.....	3-31		
Air bag-supplemental restraint system	3-33		
• Air bag system operation	3-34		
• Do not install a child restraint on a front passenger's seat	3-35		
• Air bag warning light	3-36		
• SRS components and functions	3-37		

امداد خودرو فارما

تلفن شبانه روزی: ۰۲۱-۸۸۸۶۴۸۵

FarmasOS.com

SEAT

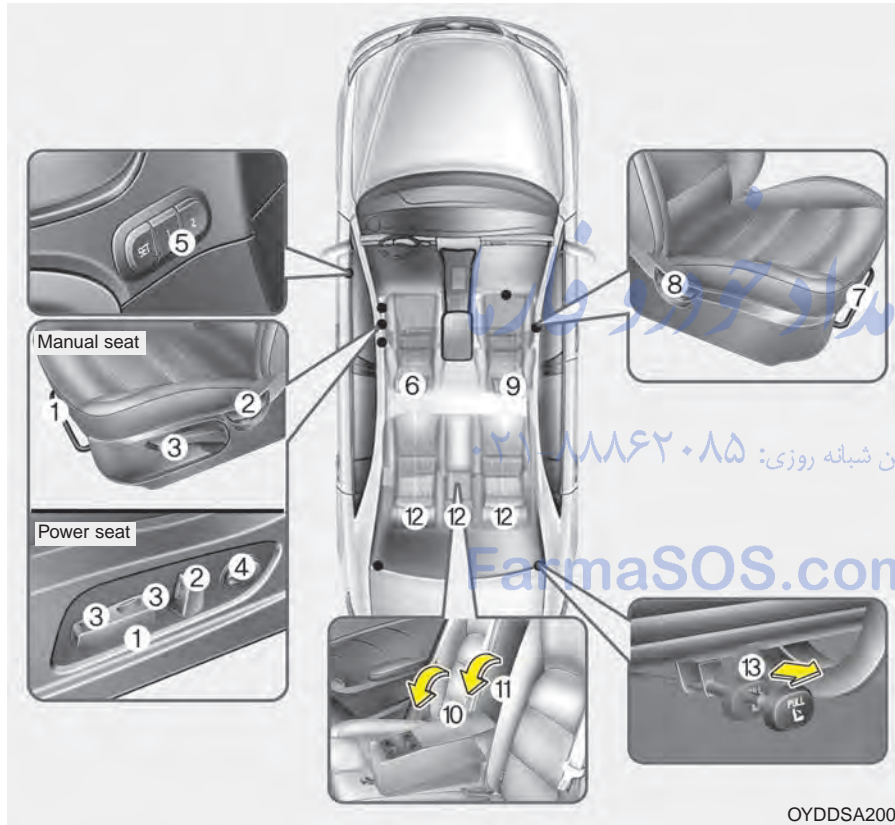

Driver's seat

- (1) Seat adjustment, forward / backward
- (2) Seatback recliner
- (3) Seat adjustment, height (for driver's seat)
- (4) Lumbar support (for driver's seat)
- (5) Driver position memory system*
- (6) Headrest

Front passenger's seat

- (7) Seat adjustment, forward / backward
- (8) Seatback recliner
- (9) Headrest

Rear seat

- (10) Armrest
- (11) Ski through
- (12) Headrest
- (13) Seat-back folding lever

* : if equipped

OYDDSA2001

⚠ WARNING - Loose objects

Do not place anything in the driver's foot well or under the front seats. Loose objects in the driver's foot area could interfere with the operation of the foot pedals.

⚠ WARNING - Uprighting seat

Do not press the release lever on a manual seatback without holding and controlling the seatback. The seatback will spring upright possibly impacting you or other passengers.

⚠ WARNING - Driver responsibility for passengers



The driver must advise the passenger to keep the seatback in an upright position whenever the vehicle is in motion. If a seat is reclined during an accident, the restraint system's ability to restrain will be greatly reduced.

⚠ WARNING - Seat cushion

Occupants should never sit on seat cushions. The passenger's hips may slide under the lap portion of the seat belt during an accident or a sudden stop.

⚠ WARNING - Driver's seat

- Never attempt to adjust the seat while the vehicle is moving. This could result in loss of control of your vehicle.
- Do not allow anything to interfere with the normal position of the seatback. Storing items against a seatback or in any other way interfering with proper locking of a seatback could result in a serious or fatal injury in a sudden stop or collision.
- Sit as far back as possible from the steering wheel while still maintaining comfortable control of your vehicle. A distance of at least 10" from your chest to the steering wheel is recommended. Failure to do so could result in air bag inflation injuries to the driver.

⚠ WARNING - Seat adjustment

- Do not adjust the seat while wearing seat belts. Moving the seat forward will cause strong pressure on the abdomen.
- Do not place your hand near the seat bottom or seat track while adjusting the seat. Your hand could get caught in the seat mechanism.

تلفن شبانه روزی: ۰۸۵-۸۸۸۶۲-۰۲۱

FarmaSOS.com

Front seat adjustment - manual
Forward and backward

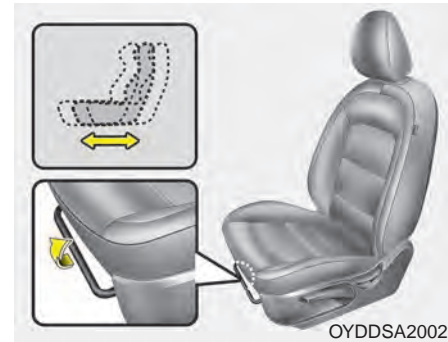

To move the seat forward or backward:

1. Pull the seat slide adjustment lever up and hold it.
2. Slide the seat to the position you desire.
3. Release the lever and make sure the seat is locked in place.

Adjust the seat before driving, and make sure the seat is locked securely by trying to move forward and backward without using the lever. If the seat moves, it is not locked properly.

⚠ WARNING - Unexpected seat movement

After adjusting a manual seat, always check that it is locked by shifting your weight to the front and back. Sudden or unexpected movement of the driver's seat could cause you to lose control of the vehicle.

Seatback angle

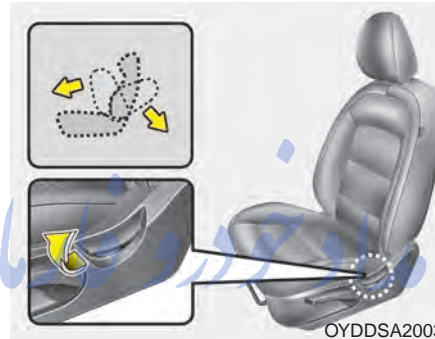

To recline the seatback:

1. Lean forward slightly and lift up the seatback recline lever.
2. Carefully lean back on the seat and adjust the seatback of the seat to the position you desire.
3. Release the lever and make sure the seatback is locked in place. (The lever **MUST** return to its original position for the seatback to lock.)

Seat cushion height (for driver's seat)

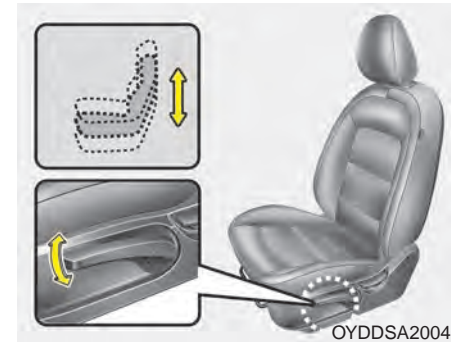

To change the height of the seat cushion push the lever upwards or downwards.

- To lower the seat cushion, push the lever down several times.
- To raise the seat cushion, push the lever up several times.

Lumbar support (for driver's seat)

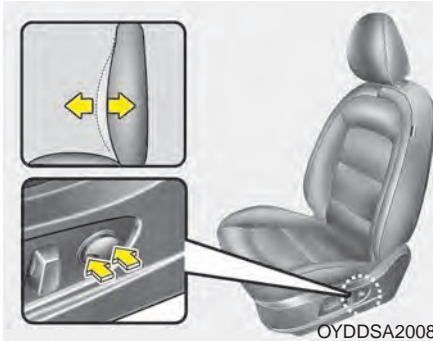

Press the front portion of the switch to increase support, or the rear portion of the switch to decrease support.

Front seat adjustment - power

The front seat can be adjusted by using the control switch located on the outside of the seat cushion. Before driving, adjust the seat to the proper position so as to easily control the steering wheel, pedals and switches on the instrument panel.

⚠ WARNING

The power seat is operable with the ignition OFF.

Therefore, children should never be left unattended in the vehicle.

⚠ CAUTION

- *The power seat is driven by an electric motor. Stop operating once the adjustment is completed. Excessive operation may damage the electrical equipment.*
- *When in operation, the power seat consumes a large amount of electrical power. To prevent unnecessary charging system drain, don't adjust the power seat longer than necessary while the engine is not running.*
- *Do not operate two or more power seat control switches at the same time. Doing so may result in power seat motor or electrical component malfunction.*

Forward and backward

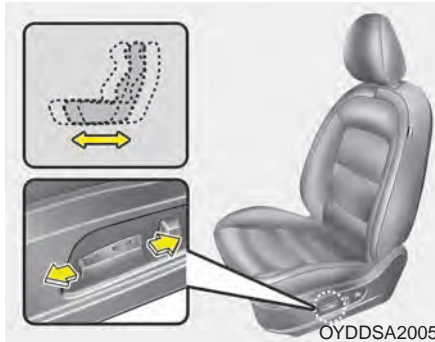

Push the control switch forward or backward to move the seat to the desired position. Release the switch once the seat reaches the desired position.

Seatback angle

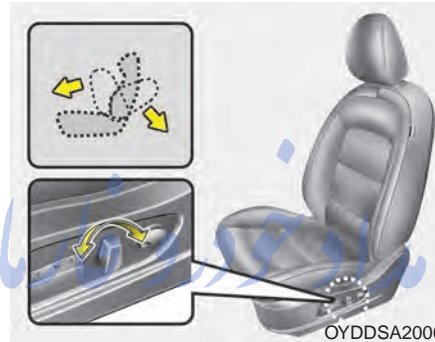

Push the control switch forward or backward to move the seatback to the desired angle. Release the switch once the seat reaches the desired position.

**Seat cushion height
(for driver's side)**

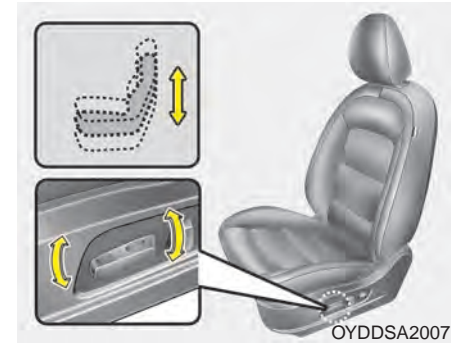

Pull the front portion of the control switch up to raise or down to lower the front part of the seat cushion. Pull the rear portion of the control switch up to raise or down to lower the rear part of the seat cushion. Release the switch once the seat reaches the desired position.

FarmaSOS.com

**Lumbar support
(for driver's seat, if equipped)**

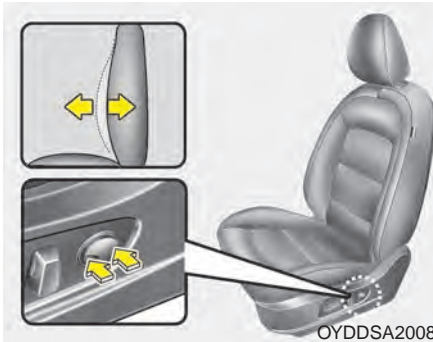

The lumbar support can be adjusted by pressing the lumbar support switch on the side of the driver's seat. Press the front portion of the switch to increase support, or the rear portion of the switch to decrease support.

**Driver position memory system
(if equipped, for power seat)**

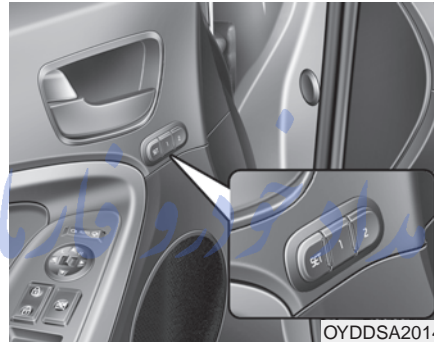

A driver position memory system is provided to store and recall the driver seat position with a simple button operation. By saving the desired position into the system memory, different drivers can reposition the driver seat based upon their driving preference. If the battery is disconnected, the desired seat position memory will need to be re-saved.

⚠ WARNING

Never attempt to operate the driver position memory system while the vehicle is moving.

This could result in loss of your vehicle, and an accident causing death, serious injury, or property damage.

Storing positions into memory using the buttons on the door

Storing driver's seat positions

1. Shift the shift lever into P while the ignition switch is ON.
2. Adjust the driver seat to position comfortable for the driver.
3. Press SET button on the control panel. The system will beep once.
4. Press one of the memory buttons (1 or 2) within 5 seconds after pressing the SET button. The system will beep twice when memory has been successfully stored.

Recalling positions from memory

1. Shift the shift lever into P while the ignition switch is ON.
2. To recall the position in memory, press the desired memory button (1 or 2). The system will beep once, then the driver seat will automatically adjust to the stored positions.

Adjusting the control switch for the driver seat while the system is recalling the stored position will cause the movement to stop and move in the direction that the control switch is moved.

تلفن شبانه روزی: ۰۲۱-۸۸۸۶۲۰۸۵

FarmaSOS.com

Easy access function (if equipped)

With the shift lever in the P position, the system will move the driver's seat automatically as follows:

- Without smart key system
 - It will move the driver's seat rearward when the ignition key is removed and front driver's door is opened.
 - It will move the driver's seat forward when the ignition key is inserted.
- With smart key system
 - It will move the driver's seat rearward when the engine start/stop button is turned to the OFF position and front driver's door is opened.
 - It will move the driver's seat forward when the engine start/stop button is turned to the ACC or START position.

You can activate or deactivate this feature. Refer to "User settings" in chapter 4.

Headrest (for front seat)

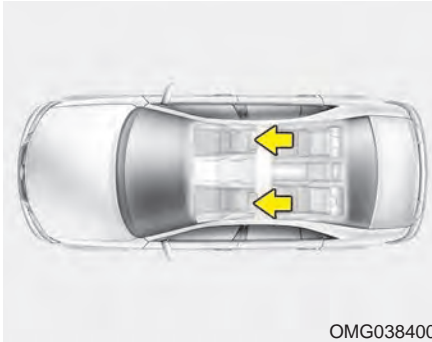

The driver's and front passenger's seats are equipped with a headrest for the occupant's safety and comfort. The headrest not only provides comfort for the driver and front passenger, but also helps protect the head and neck in the event of a collision.

For maximum effectiveness in case of an accident, the headrest should be adjusted so the middle of the headrest is at the same height of the center of gravity of an occupant's head. Generally, the center of gravity of most people's head is similar with the height of the top of their eyes. Also, adjust the headrest as close to your head as possible.

For this reason, the use of a cushion that holds the body away from the seatback is not recommended.

⚠ WARNING - Headrest removal/adjustment تفین شانه روزی

- **Do not operate the vehicle with the headrests removed. Headrests can provide critical neck and head support in a crash.**
- **Do not adjust the headrest height while the vehicle is in motion. Driver may lose control of the vehicle.**

Adjusting the height up and down

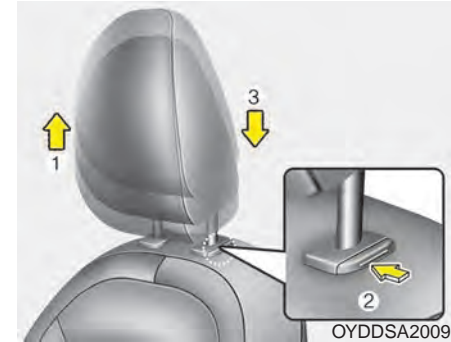

To raise the headrest, pull it up to the desired position (1). To lower the headrest, push and hold the release button (2) on the headrest support and lower the headrest to the desired position (3).

Removal and installation

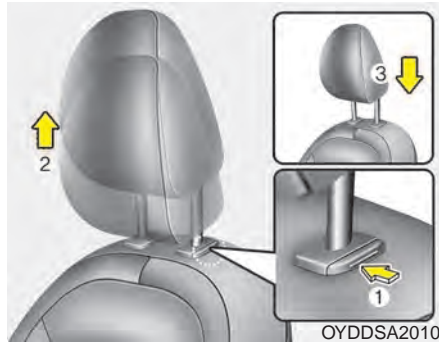

To remove the headrest, raise it as far as it can go then press the release button (1) while pulling the headrest up (2).

To reinstall the headrest, put the headrest poles (3) into the holes while pressing the release button (1). Then adjust it to the appropriate height.

Seatback pocket

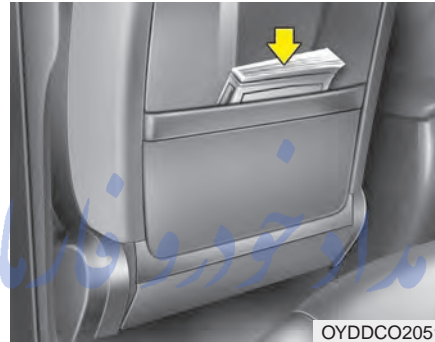

The seatback pocket is provided on the back of the front passenger's seatback.

⚠ WARNING - Seatback pocket

Do not put heavy or sharp objects in the seatback pocket. An occupant could contact such objects in a crash. Heavy objects in the front passenger seatback could also interfere with the air bag sensing system.

Rear seat adjustment

Headrest (for rear seat)

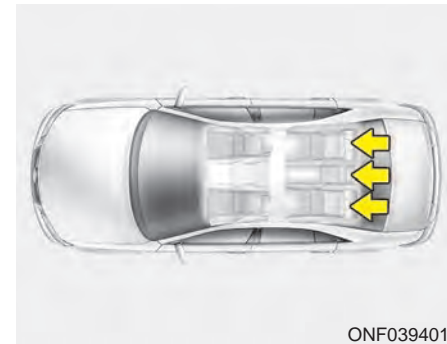

The rear seat is equipped with headrests in all the seating positions for the occupant's safety and comfort.

The headrest not only provides comfort for passengers, but also helps protect the head and neck in the event of a collision.

For maximum effectiveness in case of an accident, the headrest should be adjusted so the middle of the headrest is at the same height of the center of gravity of an occupant's head. Generally, the center of gravity of most people's head is similar with the height as the top of their eyes.

Also adjust the headrest as close to your head as possible. For this reason, the use of a cushion that holds the body away from the seatback is not recommended.

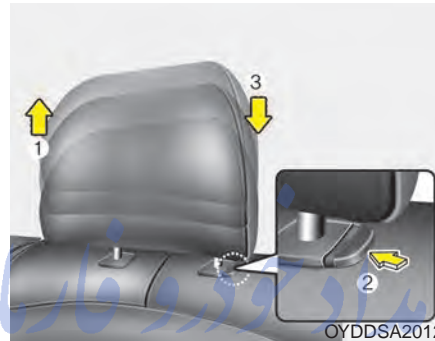

Adjusting the height up and down (if equipped)

To raise the headrest, pull it up to the desired position (1). To lower the headrest, push and hold the release button (2) on the headrest support and lower the headrest to the desired position (3).

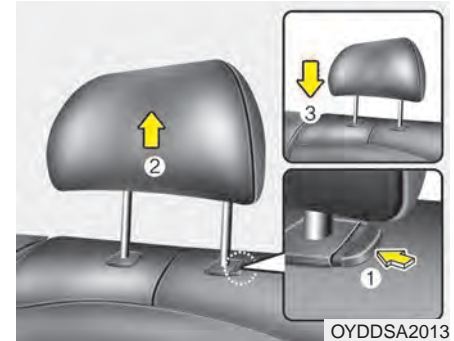

Removal and installation

To remove the headrest, raise it as far as it can go then press the release button (1) while pulling the headrest upward (2).

To reinstall the headrest, put the headrest poles (3) into the holes while pressing the release button (1). Then adjust it to the appropriate height and ensure that it locks in position.

Make sure the headrest locks in position after adjusting.

Armrest

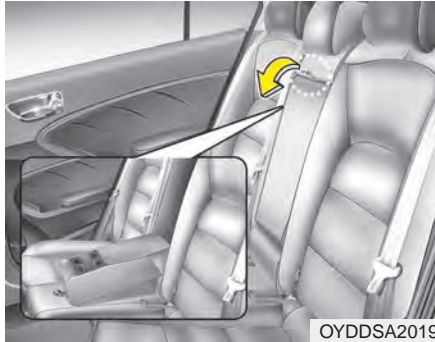

OYDDSA2019

To use the armrest, pull it forward from the seatback.

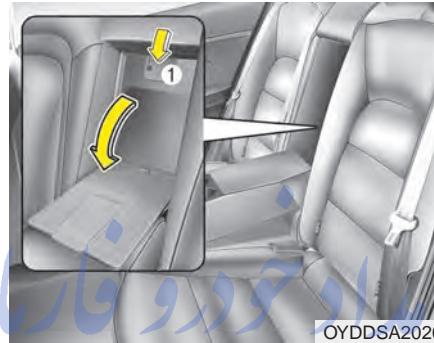

OYDDSA2020

Carrying long/narrow cargo (if equipped)

Pull the armrest down using the strap provided on the armrest. Pull the cover down while pushing the release lever down. Additional cargo space is provided to accommodate long/narrow cargo (skis, poles, lumber, etc.) not able to fit properly in the trunk when closed.

⚠ CAUTION

- **Make sure the engine is off, the shift lever is in P (for automatic transaxle or 1st (for manual transaxle) and the parking brake is applied whenever loading or unloading cargo. The vehicle may move if the shift lever is inadvertently moved to another position.**
- **Be careful when loading cargo through the rear passenger seats to prevent damage to the vehicle interior.**
- **When cargo is loaded through the rear passenger seats, ensure the cargo is properly secured to prevent it from moving while driving. Unsecured cargo in the passenger compartment can cause damage to the vehicle or injury to its occupants.**

Folding the rear seat

The rear seatbacks may be folded to facilitate carrying long items or to increase the luggage capacity of the vehicle.

⚠ WARNING

Never allow passengers to sit on top of the folded down seatback while the vehicle is moving. This is not a proper seating position and no seat belts are available for use. This could result in serious injury or death in case of an accident or sudden stop.

⚠ WARNING - Objects

Objects carried on the folded down seatback should not extend higher than the top of the front seatbacks. This could allow cargo to slide forward and cause injury or damage during sudden stops.

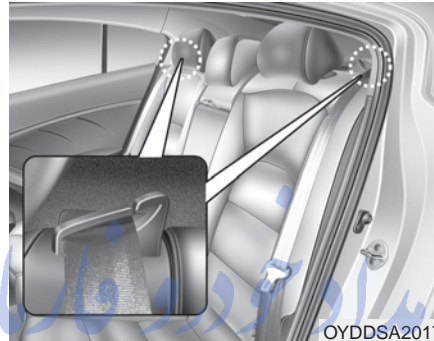

To fold the rear seatback

1. Make sure the rear seat belt webbing is in the guide to prevent the seat belt from being damaged. تلفن
2. Set the front seatback to the upright position and if necessary, slide the front seat forward.
3. Lower the rear headrests to the lowest position.
4. Open the trunk.

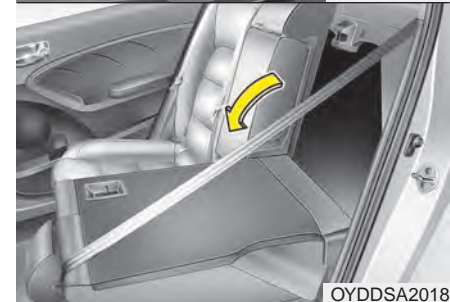
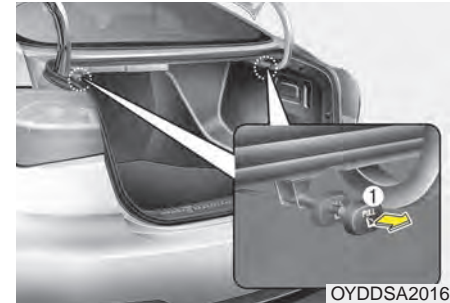

4. Pull the lock release lever (1) and fold the rear seatback forward and down firmly.

If the seat belt locks after unfolding the rear seatback, pull out the locked seat belt, release it then pull it out again.

To unfold the rear seat

1. To use the rear seat, lift and pull the seatback rearward. Pull the seatback firmly until it clicks into place. Make sure the seatback is locked in place. When you return the seatback to its upright position, always be sure it has locked into position by pushing on the top of the seatback.
2. Return the rear seat belt to the proper position.
3. When the seatback is completely installed, check the seatback folding lever again.

When returning the rear seatbacks to the upright position, remember to return the rear shoulder belts to their proper position.

⚠ WARNING - Rear seatback
When returning the rear seatback from a folded to an upright position, hold the seatback and return it slowly. Ensure that the seatback is completely locked into its upright position by pushing on the top of the seatback. In an accident or sudden stop, the unlocked seatback could allow cargo to move forward with great force and enter the passenger compartment.

⚠ WARNING - Cargo
Do not place heavy objects in the rear seats, since they cannot be properly secured and may hit vehicle occupants in a frontal collision.

SEAT BELTS

Seat belt restraint system

Seat belts are designed to bear upon the bony structure of the body, and should be worn low across the pelvis, chest and shoulders as applicable. Wearing the lap section of the belt across the abdominal area must be avoided.

Seat belts should be adjusted as firmly as possible, consistent with comfort, to provide the protection for which they have been designed.

A slack belt will greatly reduce the protection afforded to the wearer.

Care should be taken to avoid contamination of the webbing with polishes, oils and chemicals, and particularly battery acid. Cleaning may safely be carried out using mild soap and water. The belt should be replaced if webbing becomes frayed, contaminated or damaged.

- For maximum restraint system protection, the seat belts must always be used whenever the vehicle is moving. A properly positioned shoulder belt should be positioned midway over your shoulder across your collarbone.
- Never allow children to ride in the front passenger seat. See child restraint system section for further discussion.

⚠ WARNING - Shoulder belt
Never wear the shoulder belt under your arm or behind your back. An improperly positioned shoulder belt cannot protect the occupant in a crash.

⚠ WARNING - Damaged seat belt
Replace the entire seat belt assembly if any part of the webbing or hardware is damaged as you can no longer be sure that a damaged seat belt will provide protection in a crash.

⚠ WARNING - Twisted seat belt

Make sure your seat belt is not twisted when worn. A twisted seat belt may not properly protect you in an accident and could even cut into your body.

⚠ WARNING - Seat belt buckle

Do not allow foreign material (gum, crumbs, coins, etc.) to obstruct the seat belt buckle. This may prevent the seat belt from fastening securely.

**Seat belt warning
(for driver's seat)**



The driver's seat belt warning light and chime will activate to the following table when the ignition switch is in "ON" position.

Conditions		Warning Pattern	
Seat Belt	Vehicle Speed	Light-Blink	Chime-Sound
Unbuckled		6 seconds	
Buckled		6 seconds	None
Buckled → Unbuckled	Below 5 km/h (3 mph)	6 seconds	None
	5 km/h~ 10 km/h	6 seconds	
	Above 10 km/h (6 mph)	6 sec. on / 24 sec. off (11 times)	
Unbuckled	Above 10 km/h (6 mph)	6 seconds *1	
	↓ Below 5 km/h (3 mph)	↓	

*1 Warning pattern repeats 11 times with an interval of 24 seconds. If the driver's seat belt is buckled, the light will stop within 6 seconds and chime will stop immediately.

*2 The light will stop within 6 seconds and chime will stop immediately.

**Seat belt - Driver's 3-point system
with emergency locking retractor**

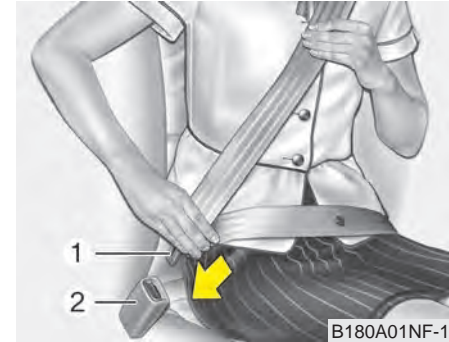

To fasten your seat belt:

To fasten your seat belt, pull it out of the retractor and insert the metal tab (1) into the buckle (2). There will be an audible "click" when the tab locks into the buckle.

The seat belt automatically adjusts to the proper length only after the lap belt portion is adjusted manually so that it fits snugly around your hips. If you lean forward in a slow, easy motion, the belt will extend and let you move around. If there is a sudden stop or impact, however, the belt will lock into position. It will also lock if you try to lean forward too quickly.

If you are unable to pull out the seat belt from the retractor, firmly pull the belt out and release it. Then you will be able to pull the belt out smoothly.

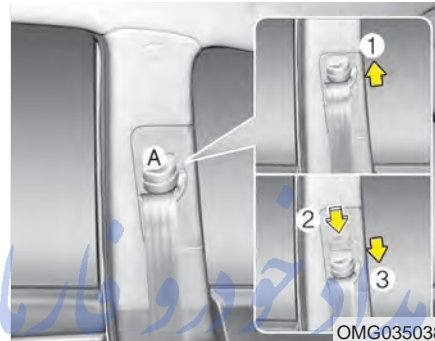

Height adjustment

You can adjust the height of the shoulder belt anchor to one of the 4 positions for maximum comfort and safety.

The height of the adjusting seat belt should not be too close to your neck. The shoulder portion should be adjusted so that it lies across your chest and midway over your shoulder nearest the door and not your neck.

To adjust the height of the seat belt anchor, lower or raise the height adjuster into an appropriate position.

To raise the height adjuster, pull it up (1). To lower it, push it down (3) while pressing the height adjuster button (2). Release the button to lock the anchor into position. Try sliding the height adjuster to make sure that it has locked into position.

⚠ WARNING - Shoulder belt positioning
Never position the shoulder belt across your neck or face.

⚠ WARNING - Seat belt replacement
Replace your seat belts after being in an accident. Failure to replace seat belts after an accident could leave you with damaged seat belts that will not provide protection in the event of another collision.

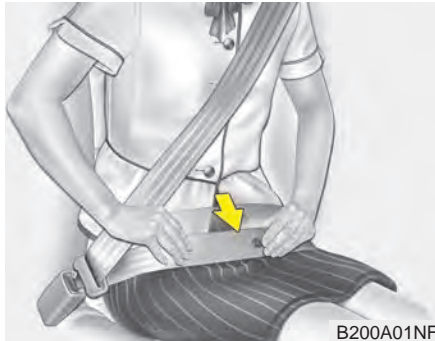

You should place the lap belt portion as low as possible and snugly across your hips. If the lap belt is located too high on your waist, it may increase the chance of injury in the event of a collision.

The arm closest to the seat belt buckle should be over the belt while the other arm should be under the belt as shown in the illustration.

Seat belts - Front passenger and rear seat 3-point system with combination locking retractor

To fasten your seat belt

Combination retractor type seat belts are installed in the rear seat positions to help accommodate the installation of child restraint systems. Although a combination retractor is also installed in the front passenger seat position, it is strongly recommended that children always be seated in the rear seat. NEVER place an infant restraint system in the front seat of the vehicle.

This type of seat belt combines the features of both an emergency locking retractor seat belt and an automatic locking retractor seat belt. To fasten your seat belt, pull it out of the retractor and insert the metal tab into the buckle. There will be an audible "click" when the tab locks into the buckle. When not securing a child restraint, the seat belt operates in the same way as the driver's seat belt (Emergency Locking Retractor Type).

It automatically adjusts to the proper length only after the lap belt portion of the seat belt is adjusted manually so that it fits snugly around your hips.

When the seat belt is fully extended from the retractor to allow the installation of a child restraint system, the seat belt operation changes to allow the belt to retract, but not to extend (Automatic Locking Retractor Type). Refer to "Using a child restraint system" in this section.

To convert from the automatic locking feature to the emergency locking operation mode, allow the unbuckled seat belt to fully retract.

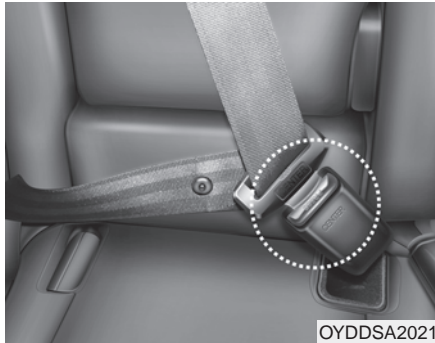

When using the rear center seat belt, the buckle with the “CENTER” mark must be used.

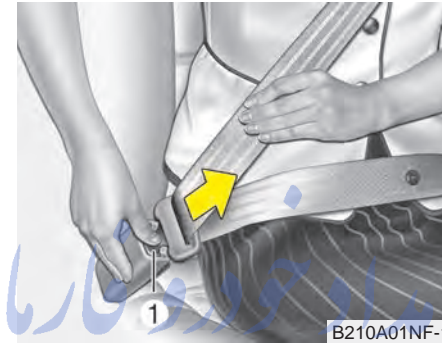

To release the seat belt

The seat belt is released by pressing the release button (1) of the locking buckle. When it is released, the belt should automatically draw back into the retractor.

If this does not happen, check the belt to be sure it is not twisted, then try again.

Pre-tensioner seat belt



Your vehicle is equipped with driver's and front passenger's pre-tensioner seat belts.

1. Retractor pre-tensioner

The retractor pre-tensioner, which is a supplement system of the seat belts. The purpose of the retractor pre-tensioner is to tighten the shoulder belt against the occupant's upper body in certain frontal collisions.

2. Emergency Fastening Device (EFD)

The Emergency Fastening Device (EFD) is a supplemental system of the seat belts. The purpose of the EFD is to tighten the lap belt against the occupant's pelvis in certain frontal collisions.

The pre-tensioner seat belts may be activated, when a frontal collision is severe enough, together with the air bags.

When the vehicle stops suddenly, or if the occupant tries to lean forward too quickly, the seat belt retractor may lock into position. In certain frontal collisions (or side collisions), the pre-tensioner may activate and pull the seat belt into tighter contact against the occupant's body.

If the system senses excessive tension on the driver or passenger's seat belt when the pre-tensioner activates, the load limiter inside the retractor pre-tensioner will release some of the pressure on the affected seat belt.

⚠ WARNING

- **Do not put anything near the buckle. Placing objects near the buckle may increase the risk of personal injury in the event of a collision.**
- **For your safety, be sure that the belt webbing is not loose or twisted and always sit properly on your seat.**

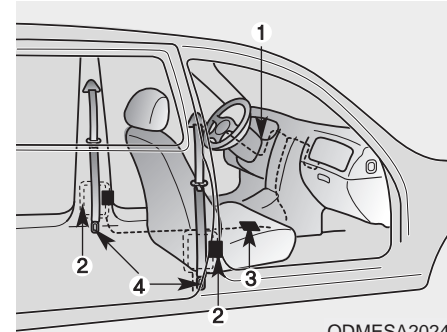

The seat belt pre-tensioner system consists mainly of the following components. Their locations are shown in the illustration:

1. SRS air bag warning light
2. Retractor pre-tensioner assembly
3. SRS control module
4. Emergency fastening device (EFD)

تلفن شبانه روزی: ۰۲۱-۸۸۶۲۰۸۵

FarmaSOS.com

⚠ WARNING

To obtain maximum benefit from a pre-tensioner seat belt:

1. The seat belt must be worn correctly and adjusted to the proper position. Please read and follow all of the important information and precautions about your vehicle's occupant safety features – including seat belts and air bags – that are provided in this manual.
2. Be sure you and your passengers always wear seat belts properly.

*** NOTICE**

When the pre-tensioner seat belts are activated, a loud noise may be heard and fine dust, which may appear to be smoke, may be visible in the passenger compartment. These are normal operating conditions and are not hazardous.

⚠ WARNING - Skin irritation

Wash all exposed skin areas thoroughly after an accident in which the pre-tensioner seat belts were activated. The fine dust from the pre-tensioner activation may cause skin irritation and should not be breathed for prolonged periods.

تلفن شبانه روزی: ۰۲۱-۸۸۸۶۲۰۸۵

FarmaSOS.com

Because the sensor that activates the SRS air bag is connected with the pre-tensioner seat belt, the SRS air bag warning light (⚠) on the instrument panel will illuminate for approximately 6 seconds after the ignition switch has been turned to the ON position, and then it should turn off.

If the pre-tensioner seat belt does not work properly, this warning light will illuminate even if the SRS air bag has not malfunctioned. If the SRS air bag warning light does not illuminate when the ignition switch is turned ON, or if it remains illuminated after illuminating for approximately 6 seconds, or if it illuminates while the vehicle is being driven, please have an authorized Kia dealer inspect the pre-tensioner seat belt or SRS air bag system as soon as possible.

*** NOTICE**

Do not attempt to service or repair the pre-tensioner seat belt system in any manner. Do not attempt to inspect or replace the pre-tensioner seat belts yourself. This must be done by an authorized Kia dealer.

⚠ WARNING - Hot pre-tensioner

Do not touch the pre-tensioner seat belt assemblies for several minutes after they have been activated. When the pre-tensioner seat belt mechanism fires during a collision the pre-tensioner becomes hot and can burn you.

Pre-tensioners are designed to operate only one time. After activation, pre-tensioner seat belts must be replaced. If the pre-tensioner must be replaced, contact an authorized Kia dealer.

Seat belt precautions

Infant or small child

You should be aware of the specific requirements in your country. Child and/or infant seats must be properly placed and installed in the rear seat. For more information about the use of these restraints, refer to "Child restraint system" in this section.

امداد خودرو فارما

تلفن شبانه روزی: ۰۲۱-۸۸۸۶۲۰۸۵

FarmaSOS.com

Larger children

Children who are too large for child restraint systems should always occupy the rear seat and use the available lap/shoulder belts. The lap portion should be fastened snug on the hips and as low as possible. Periodically check belt fit. A child's squirming could put the belt out of position. Children are given the most safety in the event of an accident when they are restrained by a proper restraint system in the rear seat. If a larger child (over age 12) must be seated in the front seat, the child should be securely restrained by the available lap/shoulder belt and the seat should be placed in the rearmost position. Children age 12 and under should be restrained securely in the rear seat. NEVER place a child age 12 and under in the front seat. NEVER place a rear facing child seat in the front seat of a vehicle.

If the shoulder belt portion slightly touches the child's neck or face, try placing the child closer to the center of the vehicle. If the shoulder belt still touches their face or neck they need to be returned to a child restraint system.

⚠ WARNING - Small children

Do not allow small children to ride in the vehicle without an appropriate child restraint system.

Restraint of pregnant women

Pregnant women should wear lap/shoulder belt assemblies whenever possible according to specific recommendations by their doctors. The lap portion of the belt should be worn **AS SNUGLY AND LOW AS POSSIBLE** on the hips, not across the abdomen.

⚠ WARNING - Pregnant women

Pregnant women must never place the lap portion of the seat belt above or on the abdomen where the fetus is located. The force of the seat belt during a collision will crush the fetus.

Injured person

A seat belt should be used when an injured person is being transported. When this is necessary, you should consult a physician for recommendations.

One person per belt

Two people (including children) should never attempt to use a single seat belt. This could increase the severity of injuries in case of an accident.

Do not lie down

To reduce the chance of injuries in the event of an accident and to achieve maximum effectiveness of the restraint system, all passengers should be sitting up and the front seats should be in an upright position when the vehicle is moving. A seat belt cannot provide proper protection if the person is lying down in the rear seat or if the front seat is in a reclined position.

Care of seat belts

Seat belt systems should never be disassembled or modified. In addition, care should be taken to assure that seat belts and belt hardware are not damaged by seat hinges, doors or other abuse.

Periodic inspection

All seat belts should be inspected periodically for wear or damage of any kind. Any damaged parts should be replaced as soon as possible.

Keep belts clean and dry

Seat belts should be kept clean and dry. If belts become dirty, they can be cleaned by using a mild soap solution and warm water. Bleach, dye, strong detergents or abrasives should not be used because they may damage and weaken the fabric.

When to replace seat belts

The entire in-use seat belt assembly or assemblies should be replaced if the vehicle has been involved in an accident. This should be done even if no damage is visible. Additional questions concerning seat belt operation should be directed to an authorized Kia dealer.

امداد خودرو فارما

تلفن شبانه روزی: ۰۲۱-۸۸۸۶۲۰۸۵

FarmaSOS.com

CHILD RESTRAINT SYSTEM

Children riding in the car should sit in the rear seat and must always be properly restrained to minimize the risk of injury in an accident, sudden stop or sudden maneuver. According to accident statistics, children are safer when properly restrained in the rear seats than in the front seat. Larger children not in a child restraint should use one of the seat belts provided.

You should be aware of the specific requirements in your country. Child and/or infant safety seats must be properly placed and installed in the rear seat. You must use a commercially available child restraint system that meets the requirements of the safety standards of your country.

Child restraint systems are designed to be secured in vehicle seats by seat belt, or by a tether anchor and/or LATCH anchors (if equipped).

Children could be injured or killed in a crash if their restraints are not properly secured. For small children and babies, a child seat or infant seat must be used. Before buying a particular child restraint system, make sure it fits your car seat and seat belts, and fits your child. Follow all the instructions provided by the manufacturer when installing the child restraint system.

⚠ WARNING- Restraint location

Never install a child or infant seat on the front passenger's seat.

A child riding in the front passenger seat can be forcefully struck by an inflating air bag.

⚠ WARNING- Hot child restraint

A child restraint system can become very hot if it is left in a closed vehicle on a sunny day. Be sure to check the seat cover, buckles and latches before placing a child in the restraint system.

When the child restraint system is not in use, store it in the luggage area or fasten it with a seat belt so that it will not be thrown forward in case of a sudden stop or an accident.

⚠ WARNING - Holding children

Never hold a child in your arms or lap when riding in a vehicle. The violent forces created during a crash will tear the child from your arms and throw the child against the car's interior.

Always use a child restraint system which is appropriate for your child's height and weight.

⚠ WARNING - Seat belt use

Do not use one seat belt for two occupants at the same time. This will eliminate any safety benefit provided by the seat belt to the occupants.

Using a child restraint system

Rear-facing child restraint system

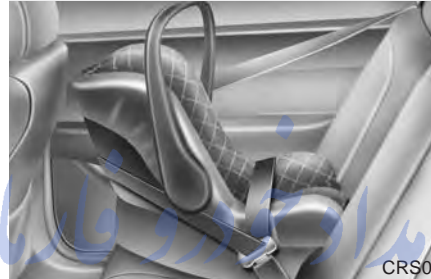

Forward-facing child restraint system



For small children and babies, the use of a child seat or infant seat is required. This child seat or infant seat should be of appropriate size for the child and should be installed in accordance with the manufacturer's instructions.

For safety reasons, we recommend that the child restraint system be used in the rear seats.

Since all passenger seat belts move freely under normal conditions and only lock under extreme or emergency conditions (emergency lock mode), you must manually change these seat belts to the auto lock mode to secure a child restraint.

If the seat belt does not operate as described in this section, have the system checked immediately by your authorized Kia dealer.

⚠ WARNING - Child seat installation

- Always follow the instructions provided by the child restraint system manufacturer. Child restraint system manufacturers know their products best.
- Failure to observe this manual's instructions regarding child restraint system and the instructions provided with the child restraint system could result in the improper installation of the child restraint system which may reduce the protection to your child in a crash or a sudden stop.

Placing a passenger seat belt into the auto lock mode

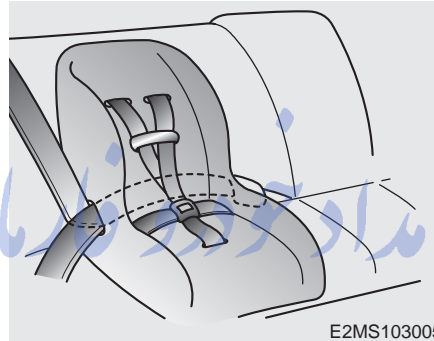

The auto lock mode will help prevent the normal movement of the child in the vehicle from causing the seat belt to loosen and compromise the child restraint system. To secure a child restraint system, use the following procedure.

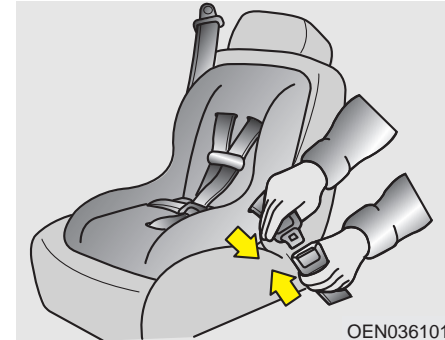

To install a child restraint system on the outboard or center rear seats, do the following:

1. Place the child restraint system in the seat and route the lap/shoulder belt around or through the restraint, following the restraint manufacturer's instructions. Be sure the seat belt webbing is not twisted.
2. Fasten the lap/shoulder belt latch into the buckle. Listen for the distinct "click" sound.

Position the release button so that it is easy to access in case of an emergency.

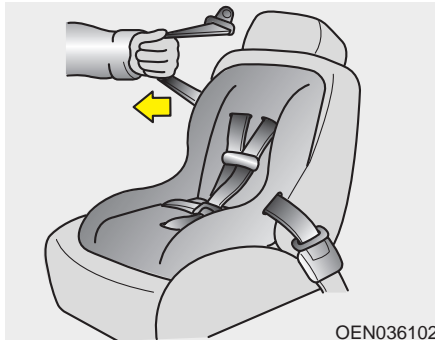

OEN036102

3. Pull the shoulder portion of the seat belt all the way out. When the shoulder portion of the seat belt is fully extended, it will shift the retractor to the “Auto Lock” (child restraint) mode.



OEN036103

4. Slowly allow the shoulder portion of the seat belt to retract and listen for an audible “clicking” or “ratcheting” sound. This indicates that the retractor is in the “Auto Lock” mode. If no distinct sound is heard, repeat steps 3 and 4.

FarmaSOS.com

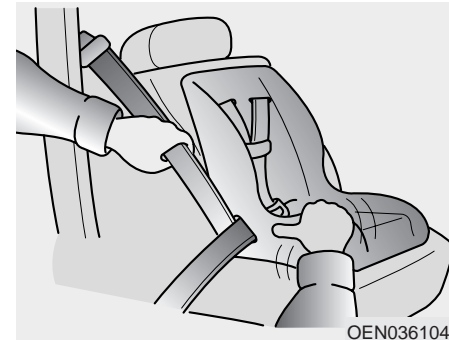

OEN036104

5. Remove as much slack from the belt as possible by pushing down on the child restraint system while feeding the shoulder belt back into the retractor.

6. Push and pull on the child restraint system to confirm that the seat belt is holding it firmly in place. If it is not, release the seat belt and repeat steps 2 through 6.

7. Double check that the retractor is in the “Auto Lock” mode by attempting to pull more of the seat belt out of the retractor. If you cannot, the retractor is in the “Auto Lock” mode.

The lap/shoulder belt automatically returns to the “emergency lock mode” whenever the belt is allowed to retract fully.

Therefore, the preceding seven steps must be followed each time a child restraint is installed.

To remove the child restraint, press the release button on the buckle and then pull the lap/shoulder belt out of the restraint and allow the seat belt to retract fully.

⚠ WARNING - Auto lock mode

Set the retractor to Automatic Lock mode when installing any child restraint system.

If the retractor is not in the Auto Lock mode, the child restraint can move when your vehicle turns or stops suddenly.

Securing a child restraint seat with tether anchorage system

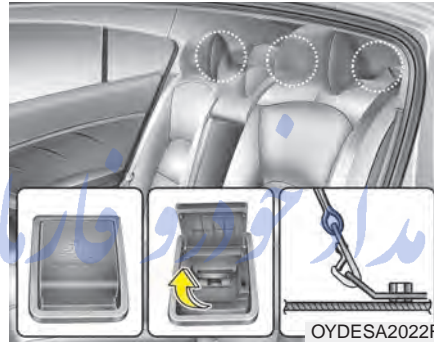

Child restraint hook holders are located on the package tray.



This symbol indicates the position of the tether anchor.



1. Route the child restraint seat tether strap over the seatback.

For vehicles with adjustable headrests, route the tether strap under the headrest (remove the headrest and re-install it) and between the headrest posts, otherwise route the tether strap over the top of the seatback.

2. Connect the tether strap hook to the appropriate child restraint hook holder and tighten to secure the child restraint seat.

⚠ WARNING - Tether strap
Never mount more than one child restraint to a single tether or to a single lower anchorage point. The increased load caused by multiple seats may cause the tethers or anchorage points to break.

Check that the child restraint system is secure by pushing and pulling it in different directions. Incorrectly fitted child restraints may swing, twist, tip or separate causing death or serious injury.

Securing a child restraint seat with child seat lower anchor system

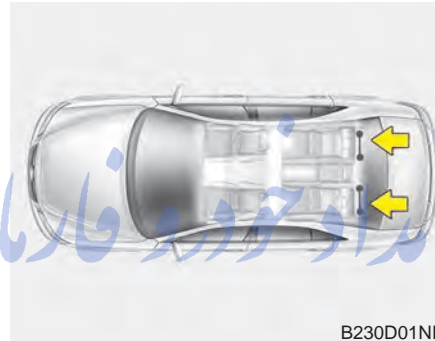

B230D01NF

Some child seat manufacturers make child restraint seats that are labeled as LATCH or LATCH-compatible child restraint seats. LATCH stands for "Lower Anchors and Tethers for Children". These seats include two rigid or webbing mounted attachments that connect to two LATCH anchors at specific seating positions in your vehicle. This type of child restraint seat eliminates the need to use seat belts to attach the child seat in the rear seats.

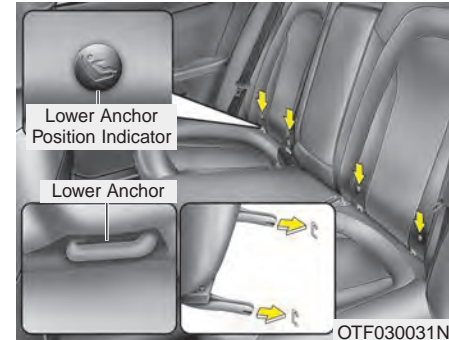

Child restraint symbols are located on the left and right rear seat backs to indicate the position of the lower anchors for child restraints.

⚠ WARNING - Unused rear seatbelts
Always fasten the seatbelts behind the child restraint seat when they are not used to secure the child seat. Failure to do so may result in child strangulation.

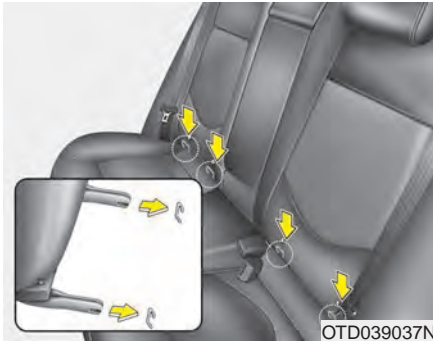

LATCH anchors have been provided in your vehicle. The LATCH anchors are located in the left and right outboard rear seating positions. Their locations are shown in the illustration. There is no LATCH anchor provided for the center rear seating position.

The LATCH anchors are located between the seatback and the seat cushion of the rear seat left and right outboard seating positions.

When you install your child's restraint system using the LATCH anchors buckle the shoulder lap belt, then lock the retractor and pull the belt to remove the slack in the belt so it lies flat against the vehicle seat.

Follow the child seat manufacturer's instructions to properly install child restraint seats with LATCH or LATCH-compatible attachments.

Once you have installed the LATCH child restraint, assure that the seat is properly attached to the LATCH and tether anchors.

Also, test the child restraint seat before you place the child in it. Tilt the seat from side to side. Also try to tug the seat forward. Check to see if the anchors hold the seat in place.

⚠ WARNING - LATCH lower anchors

Never attempt to attach a LATCH equipped seat in the center seating position. LATCH lower anchors are only to be used with the left and right rear outboard seating positions. You may damage the anchors or the anchors may fail and break in a collision.

تلفن شبانه روزی: ۰۲۱-۸۸۶۲۰۸۵

FarmaSOS.com

AIR BAG - ADVANCED SUPPLEMENTAL RESTRAINT SYSTEM

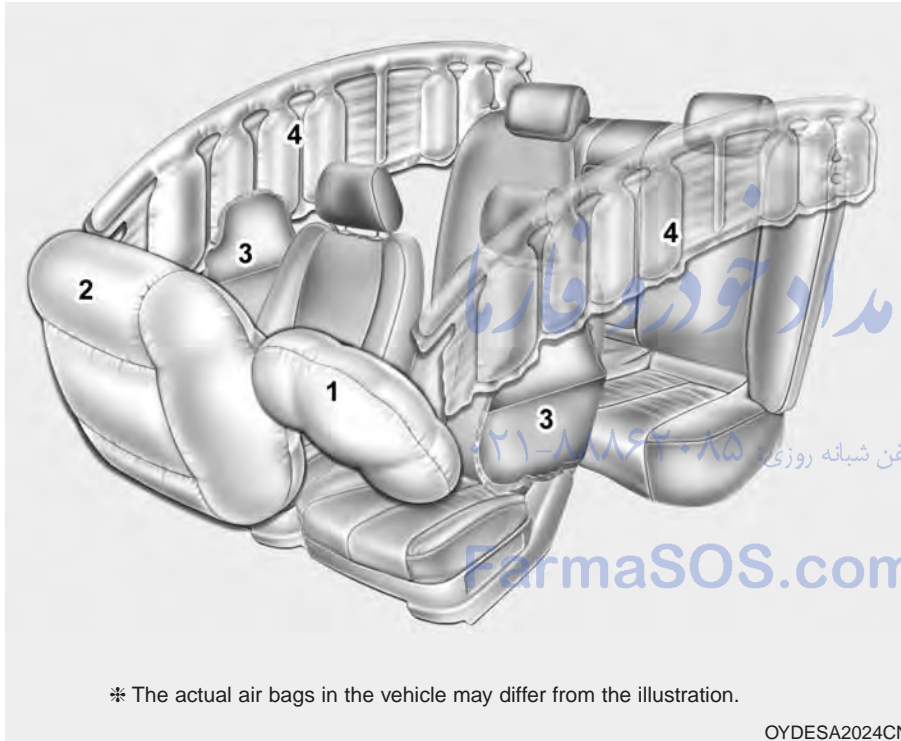

- (1) Driver's front air bag
- (2) Passenger's front air bag
- (3) Side air bag
- (4) Curtain air bag

Even in vehicles with air bags, you and your passengers must always wear the safety belts provided in order to minimize the risk and severity of injury in the event of a collision or rollover.

* The actual air bags in the vehicle may differ from the illustration.

OYDESA2024CN

How does the air bag system operate

- Air bags are activated (able to inflate if necessary) only when the ignition switch is turned to the ON or START the appropriate position.
- Air bags inflate instantly in the event of serious frontal or side collision (if equipped with side air bag or curtain air bag) in order to help protect the occupants from serious physical injury.
- There is no single speed at which the air bags will inflate.

Generally, air bags are designed to inflate based upon the severity of a collision and its direction. These two factors determine whether the sensors produce an electronic deployment/ inflation signal.

- Air bag deployment depends on a number of complex factors including vehicle speed, angles of impact and the density and stiffness of the vehicles or objects which your vehicle hits in the collision. Though, factors are not limited to those mentioned above.

- The front air bags will completely inflate and deflate in an instant.

It is virtually impossible for you to see the air bags inflate during an accident. It is much more likely that you will simply see the deflated air bags hanging out of their storage compartments after the collision.

- In order to help provide protection in a severe collision, the air bags must inflate rapidly. The speed of air bag inflation is a consequence of extremely short time in which a collision occurs and the need to get the air bag between the occupant and the vehicle structures before the occupant impacts those structures. This speed of inflation reduces the risk of serious or life-threatening injuries in a severe collision and is thus a necessary part of air bag design.

However, air bag inflation can also cause injuries which can include facial abrasions, bruises and broken bones because the inflation speed also causes the air bags to expand with a great deal of force.

- **There are even circumstances under which contact with the steering wheel air bag can cause fatal injuries, especially if the occupant is positioned excessively close to the steering wheel.**

Noise and smoke

When the air bags inflate, they make a loud noise and they leave smoke and powder in the air inside of the vehicle. This is normal and is a result of the ignition of the air bag inflator. After the air bag inflates, you may feel substantial discomfort in breathing due to the contact of your chest to both the seat belt and the air bag, as well as from breathing the smoke and powder. **Open your doors and/or windows as soon as possible after the impact in order to reduce discomfort and prevent prolonged exposure to smoke and powder.**

Though smoke and powder are non-toxic, they may cause irritation to the skin (eyes, nose and throat, etc). If this is the case, wash and rinse with cold water immediately and consult a doctor if the symptom persists.

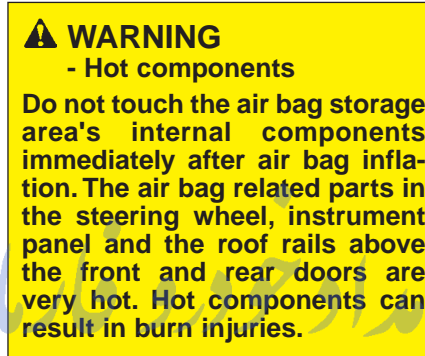

تلفن شبانه روزی: +۲۱-۸۸۸۶۲۰۸۵

FarmaSOS.com

Installing a child restraint on a front passenger's seat is forbidden



1JBH3051

Never place a rear-facing child restraint in the front passenger's seat. If the air bag deploys, it would impact the rear-facing child restraint, causing serious or fatal injury.

In addition, do not place front-facing child restraint in the front passenger's seat either. If the front passenger air bag inflates, it would cause serious or fatal injuries to the child.

⚠ WARNING - Air bag deployment

When children are seated in the rear outboard seats of a vehicle equipped with side and/or curtain air bags, install the child restraint system as far away from the door side as possible. Inflation of the side and/or curtain air bags could impact the child.

Air bag warning light



The purpose of the air bag warning light in your instrument panel is to alert you of a potential problem with your air bag - Supplemental Restraint System (SRS).

When the ignition switch is turned ON, the indicator light should illuminate for approximately 6 seconds, then go off.

Have the system checked by an authorized Kia dealer if:

- The light does not turn on briefly when you turn the ignition ON.
- The light stays on after illuminating for approximately 6 seconds.
- The light comes on while the vehicle is in motion.

SRS components and functions

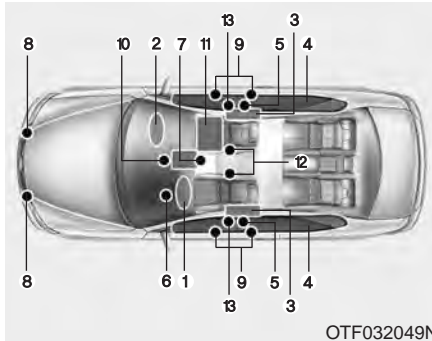

OTF032049N

The SRS consists of the following components:

1. Driver's front air bag module
2. Passenger's front air bag module
3. Side air bag modules
4. Curtain air bag modules
5. Retractor pre-tensioner assemblies*
6. Air bag warning light
7. SRS control module (SRSCM)
8. Front impact sensors
9. Side impact sensors

10. PASSENGER AIR BAG "OFF" indicator (Front passenger's seat only)
11. Occupant detection system (Front passenger's seat only)
12. Driver's and front passenger's seat belt buckle sensors
13. Emergency fastening device (EFD)

* : if equipped

The SRSCM continually monitors all SRS components while the ignition switch is ON to determine if a crash impact is severe enough to require air bag deployment or pre-tensioner seat belt deployment.

The SRS air bag warning light on the instrument panel will illuminate for about 6 seconds after the ignition switch is turned to the ON position, after which the air bag warning light should go out.

If any of the following conditions occurs, this indicates a malfunction of the SRS. Have an authorized Kia dealer inspect the air bag system as soon as possible.

- The light does not turn on briefly when you turn the ignition ON.
- The light stays on after illuminating for approximately 6 seconds.
- The light comes on while the vehicle is in motion.

Safety features of your vehicle

Driver's front air bag (1)



The air bag modules are located both in the center of the steering wheel and in the front passenger's panel above the glove box. When the SRSCM detects a sufficiently severe impact to the front of the vehicle, it will automatically deploy the front air bags.

Driver's front air bag (2)

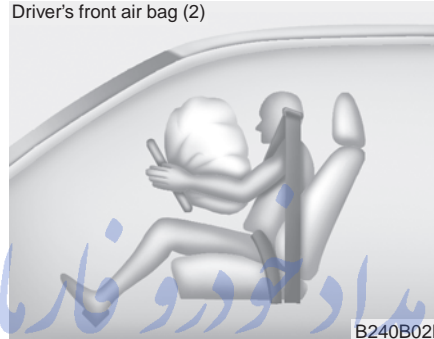

Upon deployment, tear seams molded directly into the pad covers will separate under pressure from the expansion of the air bags. Further opening of the covers then allows full inflation of the air bags.

Driver's front air bag (3)

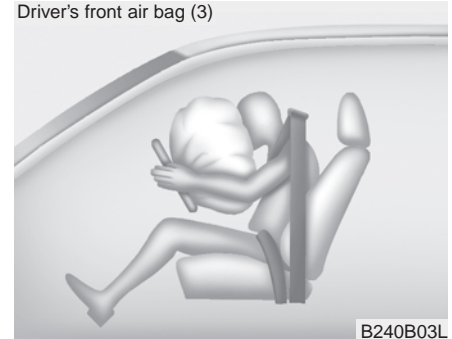

A fully inflated air bag, in combination with a properly worn seat belt, slows the driver's or the passenger's forward motion, reducing the risk of head and chest injury.

After complete inflation, the air bag immediately starts deflating, enabling the driver to maintain forward visibility and the ability to steer or operate other controls.

FarmaSOS.com

Passenger's front air bag

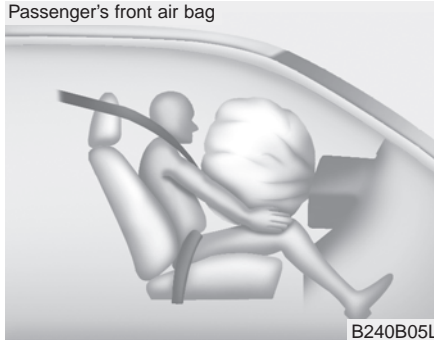

B240B05L

⚠ WARNING - Air bag obstructions

Do not install or place any accessories on the steering wheel, instrument panel, or on the front passenger's panel above the glove box in a vehicle. Such objects may become dangerous projectiles if the air bag deploys.

*** NOTICE**

Before you replace a fuse or disconnect a battery terminal, turn the ignition switch to the LOCK position and remove the ignition key. Never remove or replace the air bag related fuse(s) when the ignition switch is in the ON position. Failure to heed this warning will cause the SRS air bag warning light to illuminate.

تلفن شبانه روزی: ۰۲۱-۸۸۸۶۲۰۸۵

FarmaSOS.com

Occupant detection system



OYDNSA2037

Your vehicle is equipped with an occupant detection system in the front passenger's seat.

The occupant detection system is designed to detect the presence of a properly-seated front passenger and determine if the passenger's front air bag should be enabled (may inflate) or not. The driver's front air bag is not affected or controlled by the occupant detection system.

Main components of occupant detection system

- A detection device located within the front passenger seat track.
- Electronic system to determine whether passenger air bag systems should be activated or deactivated.
- An indicator light located on the instrument panel which illuminates the words PASSENGER AIR BAG “OFF” indicating the front passenger air bag system is deactivated.
- The instrument panel air bag warning light is interconnected with the occupant detection system.

If the front passenger seat is occupied by a person that the system determines to be of adult size, and he/she sits properly (sitting upright with the seatback in an upright position, centered on the seat cushion with their seat belt on, legs comfortably extended and their feet on the floor), the PASSENGER AIR BAG “OFF” indicator will turn off and the front passenger’s air bag will be able to inflate, if necessary, in frontal crashes.

You will find the PASSENGER AIR BAG “OFF” indicator on the center facia panel. This system detects the conditions 1–4 in the following table and activates or deactivates the front passenger air bag based on these conditions.

Always be sure that you and all vehicle occupants are seated and restrained properly (sitting upright with the seat in an upright position, centered on the seat cushion, with the person’s legs comfortably extended, feet on the floor, and wearing the safety belt properly) for the most effective protection by the air bag and the safety belt.

- The ODS (Occupant Detection System) may not function properly if the passenger takes actions which can defeat the detection system. These include:
 - (1) Failing to sit in an upright position.
 - (2) Leaning against the door or center console.
 - (3) Sitting towards the sides or the front of the seat.
 - (4) Putting legs on the dashboard or resting them on other locations which reduce the passenger weight on the front seat.
 - (5) Improperly wearing the safety belt.
 - (6) Reclining the seat back.

Condition and operation in the front passenger occupant detection system

Condition detected by the occupant detection system	Indicator/Warning light		Devices
	PASSENGER AIR BAG "OFF" indicator light	SRS warning light	Front passenger air bag
1. Adult *1 or child age 13 and up*2	Off	Off	Activated
2. Infant or child restraint system with 12 months old*3 *4	On	Off	Deactivated
3. Unoccupied	On	Off	Deactivated
4. Malfunction in the system	Off	On	Activated

- *1) The system judges a person of adult size as an adult. When a smaller adult sits in the front passenger seat, the system may recognize him/her as a child depending on his/her physique and posture.
- *2) Do not allow children to ride in the front passenger seat. When a smaller child than the same age sits in the front passenger seat, the system may recognize him/her as an infant depending on his/her physique or posture.
- *3) Never install a child restraint system on the front passenger seat.
- *4) The PASSENGER AIR BAG "OFF" indicator may turn on or off when a child above 12 months to 12 years old (with or without child restraint system) sits in the front passenger seat. This is a normal condition.

⚠ WARNING - ODS system
Riding in an improper position adversely affects the occupant detection system (ODS) and may result in the deactivation of front passenger air bag. It is important for the driver to instruct the passenger as to the proper seating instructions as contained in this manual.
(Continued)

(Continued)



- Never put a heavy load in the front passenger seat.



- Never sit with the hips shifted towards the front of the seat.



- Never place the feet on the dashboard.



- Never place the feet on the front passenger seatback.

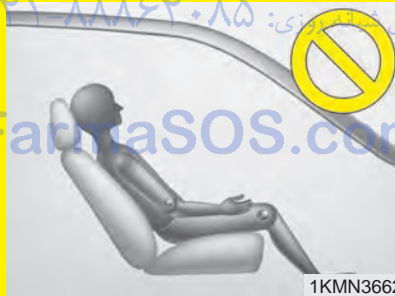

- Never excessively recline the front passenger seatback.



- Never lean on the door or center console.
- Never sit on one side of the front passenger seat.

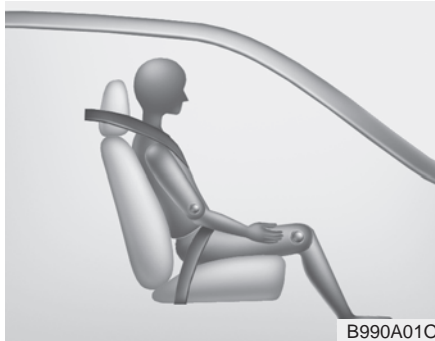

B990A010

When an adult is seated in the front passenger seat, if the PASSENGER AIR BAG “OFF” indicator is on, turn the ignition switch to the LOCK position and ask the passenger to sit properly (sitting upright with the seat back in an upright position, centered on the seat cushion with their seat belt on, legs comfortably extended and their feet on the floor). Restart the engine and have the person remain in that position. This will allow the system to detect the person and to enable the passenger air bag.

If the PASSENGER AIR BAG “OFF” indicator is still on, ask the passenger to move to the rear seat.

⚠ WARNING - “AIR BAG OFF” light

Do not allow an adult passenger to ride in the front seat when the PASSENGER AIR BAG “OFF” indicator is illuminated, because the air bag will not deploy in the event of a crash. The driver must instruct the passenger to reposition himself in the seat. Failure to properly position yourself may lead to air bag deactivation resulting in air bag non-deployment and in a collision. If the PASSENGER AIR BAG “OFF” indicator remains illuminated after the passenger repositions themselves properly and the car is restarted, it is recommended that passenger move to the rear seat because the passenger’s front air bag will not deploy.

*** NOTICE**

The PASSENGER AIR BAG “OFF” indicator illuminates for about 4 seconds after the ignition switch is turned to the ON position or after the engine is started. If the front passenger seat is occupied, the occupant detection sensor will then classify the front passenger after several more seconds.

Any child age 12 and under should ride in the rear seat. Children too large for child restraints should use the available lap/shoulder belts. No matter what type of crash, children of all ages are safer when restrained in the rear seat.

* NOTICE

Do not modify or replace the front passenger seat. Don't place anything on or attach anything such as a blanket, front seat covers or after market seat heater to the front passenger seat. This can adversely affect the occupant detection system.

If the occupant detection system is not working properly, the SRS air bag warning light  on the instrument panel will illuminate because the passenger's front air bag is connected with the occupant detection system. If there is a malfunction of the occupant detection system, the PASSENGER AIR BAG "OFF" indicator will not illuminate and the passenger's front air bag will inflate in frontal impact crashes even if there is no occupant in the front passenger's seat.

تلفن شبانه روزی: ۰۲۱-۸۸۸۶۲۰۸۵

FarmaSOS.com

Driver's and passenger's front air bag



Your vehicle is equipped with an Advanced Supplemental Restraint (Air Bag) System and lap/shoulder belts at both the driver and passenger seating position.

The indications of the system's presence are the letters "AIR BAG" embossed on the air bag pad cover in the steering wheel and the passenger's side front panel pad above the glove box.

The SRS consists of air bags installed under the pad covers in the center of the steering wheel and the passenger's side front panel above the glove box.

The purpose of the SRS is to provide the vehicle's driver and/or the front passenger with additional protection than that offered by the seat belt system alone in case of a frontal impact of sufficient severity. The SRS uses sensors to gather information about the driver's seat position, the driver's and front passenger's seat belt usage and impact severity.

The advanced SRS offers the ability to control the air bag inflation with two levels. A first stage level is provided for moderate-severity impacts. A second stage level is provided for more severe impacts.

The passenger's front air bag is designed to help reduce the injury of children sitting close to the instrument panel in low speed collisions. However, children are safer if they are restraint in the rear seat.

According to the impact severity, seating position and seat belt usage, the SRSCM (SRS Control Module) controls the air bag inflation. Failure to properly wear seat belts can increase the risk or severity of injury in an accident.

Additionally, your vehicle is equipped with an occupant detection system in the front passenger's seat. The occupant detection system detects the presence of a passenger in the front passenger's seat and will turn off the front passenger's air bag under certain conditions. For more detail, see "Occupant detection system" in this section.

Do not place any objects that may cause magnetic fields near the front seat. These may cause a malfunction of the seat track position sensor.

Safety features of your vehicle

Manufacturers are required by government regulations to provide a contact point concerning modifications to the vehicle for persons with disabilities, which modifications may affect the vehicle's advanced air bag system. However, Kia does not endorse nor will it support any changes to any part or structure of the vehicle that could affect the advanced air bag system, including the occupant detection system.

⚠ WARNING - Replacement/modifications

The front passenger seat, dashboard or door should not be replaced except by an authorized Kia dealer using original Kia parts designed for this vehicle and model. Any other such replacement or modification could adversely affect the operation of the occupant detection system and your advanced air bags.

Advanced air bags are combined with pre-tensioner seat belts to help provide enhanced occupant protection in frontal crashes. Front air bags are not intended to deploy in collisions in which sufficient protection can be provided by the pre-tensioner seat belt alone.

⚠ WARNING - SRS Wiring

Do not tamper with or disconnect SRS wiring or other components of the SRS system. Doing so could result in injury, due to accidental deployment of the air bags or by rendering the SRS inoperative.

Front air bags are not intended to deploy in side-impact, rear-impact or rollover crashes. In addition, front air bags will not deploy in frontal crashes below the deployment threshold.

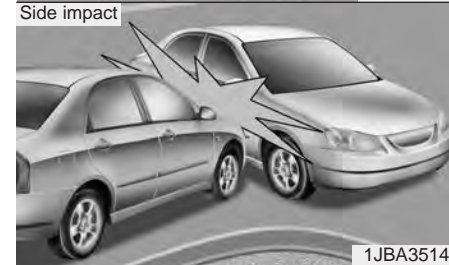

Side air bag

Front

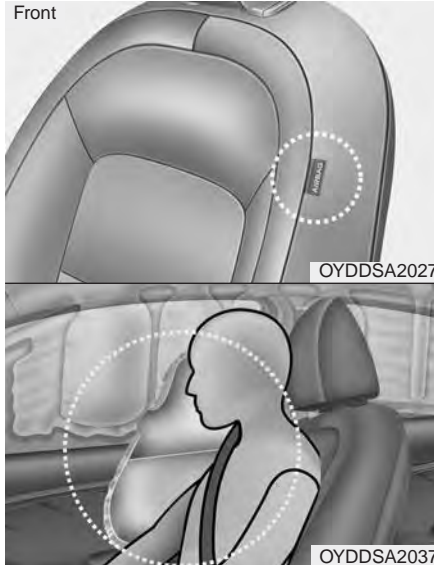

* The actual air bags in the vehicle may differ from the illustration.

Your vehicle is equipped with a side air bag in each front seat.

The purpose of the air bag is to provide the vehicle's driver and/or the front passenger with additional protection than that offered by the seat belt alone.

The side air bags are designed to deploy only during certain side-impact collisions, depending on the crash severity, angle, speed and point of impact. The side air bags are not designed to deploy in all side impact situations.

⚠ WARNING - Unexpected deployment

Avoid impact to the side air bag sensor when the ignition switch is ON to prevent unexpected deployment of the side air bag.

The side air bag is supplemental to the driver's and the passenger's seat belt systems and is not a substitute for them. Therefore your seat belts must be worn at all times while the vehicle is in operation.

For best protection from the side air bag system and to avoid being injured by the deploying side air bag, both front seat occupants should sit in an upright position with the seat belt properly fastened. The driver's hands should be placed on the steering wheel at the 9:00 and 3:00 positions. The passenger's arms and hands should be placed on their laps.

⚠ WARNING - Deployment

Do not install any accessories including seat covers, on the side or near the side air bag as this may affect the deployment of the side air bags.

If seat or seat cover is damaged, have the vehicle checked and repaired by an authorized Kia dealer. Inform that your vehicle is equipped with side air bags and an occupant detection system.

⚠ WARNING - Flying objects

Do not place any objects (an umbrella, bag, etc.) between the front door and the front seat. Such objects may become dangerous projectiles if the side air bag inflates.

Curtain air bag

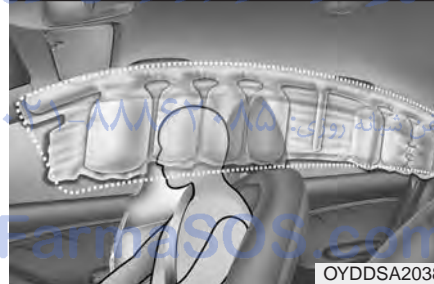

* The actual air bags in the vehicle may differ from the illustration.

Curtain air bags are located along both sides of the roof rails above the front and rear doors.

They are designed to help protect the heads of the front seat occupants and the rear outboard seat occupants in certain side impact collisions.

The curtain air bags are designed to deploy only during certain side impact collisions, depending on the crash severity, angle, speed and impact. The curtain air bags are not designed to deploy in all side impact situations, collisions from the front or rear of the vehicle or in most rollover situations.

Do not allow the passengers to lean their heads or bodies onto doors, put their arms on the doors, stretch their arms out of the window, or place objects between the doors and passengers when they are seated on seats equipped with side and/or curtain air bags.

* NOTICE

Never try to open or repair any components of the side curtain air bag system. This should only be done by an authorized Kia dealer.

Why didn't my air bag go off in a collision? (Inflation and non-inflation conditions of the air bag)

There are many types of accidents in which the air bag would not be expected to provide additional protection.

These include rear impacts, second or third collisions in multiple impact accidents, as well as low speed impacts.

Air bag collision sensors

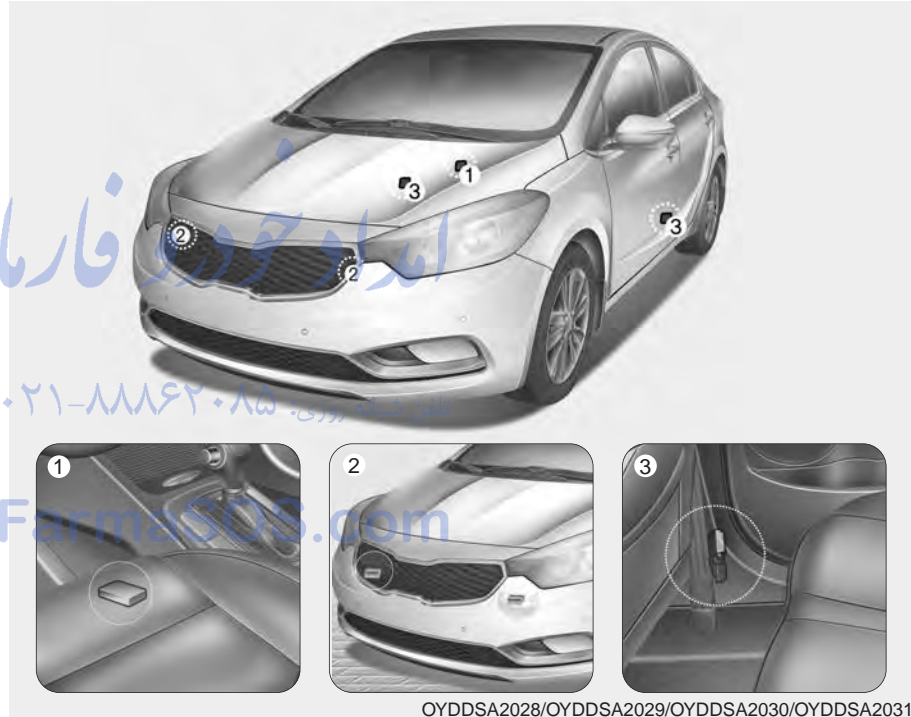

(1) SRS control module
(2) Front impact sensor

(3) Side impact sensor

⚠ WARNING - Air bag sensors

- Do not hit or allow any objects to impact the locations where air bag or sensors are installed.

This may cause unexpected air bag deployment, which could result in serious personal injury or death.

- If the installation location or angle of the sensors is altered in any way, the air bags may deploy when they should not or they may not deploy when they should.

Therefore, do not try to perform maintenance on or around the air bag sensors. Have the vehicle checked and repaired by an authorized Kia dealer.

Problems may arise if the sensor installation angles are changed due to the deformation of the front bumper, body or B pillar where side collision sensors are installed. Have the vehicle checked and repaired by an authorized Kia dealer.

Installing aftermarket bumper guards or replacing a bumper with non-genuine parts may adversely affect your vehicle's collision and air bag deployment performance.

تلفن شبانه روزی: ۰۲۱-۸۸۶۲۰۸۵

FarmaSOS.com

Air bag inflation conditions



Front air bags

Front air bags are designed to inflate in a frontal collision depending on the intensity, speed or angles of impact of the front collision.

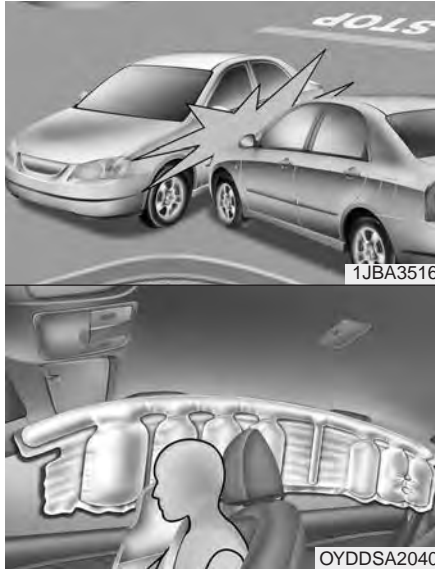

* The actual air bags in the vehicle may differ from the illustration.

Side air bags

Side air bags (side and/or curtain air bags) are designed to inflate when an impact is detected by side collision sensors depending on the strength, speed or angles of impact resulting from a side impact collision.

Although the front air bags (driver's and front passenger's air bags) are designed to inflate in frontal collisions, they also may inflate in other types of collisions if the front impact sensors detect a sufficient frontal force in another type of impact. Side and curtain air bags are designed to inflate in certain side impact collisions. They may inflate in other type of collisions where a side force is detected by the sensors.

If the vehicle chassis is impacted by bumps or objects on unimproved roads or sidewalks, air bags may deploy. Drive carefully on unimproved roads or on surfaces not designed for vehicle traffic to prevent unintended air bag deployment.

FarmaSOS.com

Air bag non-inflation conditions



- In certain low-speed collisions the air bags may not deploy. The air bags are designed not to deploy in such cases because they may not provide benefits beyond the protection of the seat belts in such collisions.

Safety features of your vehicle

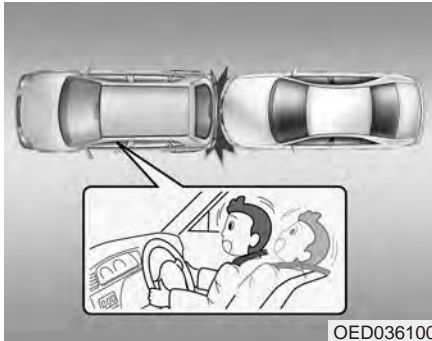

- Air bags are not designed to inflate in rear collisions, because occupants are moved backward by the force of the impact. In this case, inflated air bags would not be able to provide any additional benefit.



- Front air bags may not inflate in side impact collisions, because occupants move to the direction of the collision, and thus, in side impacts, front air bag deployment would not provide additional occupant protection.

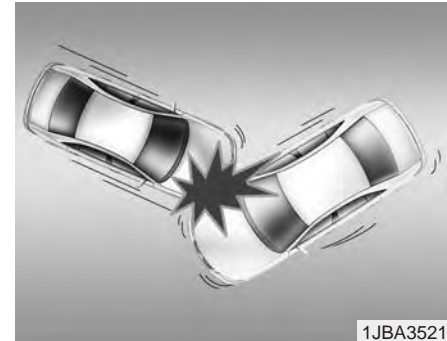

- In a slant or angled collision, the force of impact may direct the occupants in a direction where the air bags would not be able to provide any additional benefit, and thus the sensors may not deploy any air bags.

FarmaSOS.com



- Just before impact, drivers often brake heavily. Such heavy braking lowers the front portion of the vehicle causing it to “ride” under a vehicle with a higher ground clearance. Air bags may not inflate in this “under-ride” situation because deceleration forces that are detected by sensors may be significantly replaced by such “under-ride” collisions.



- Air bags do not inflate in all rollover accidents, even though the vehicle is equipped with side air bags and curtain air bags.

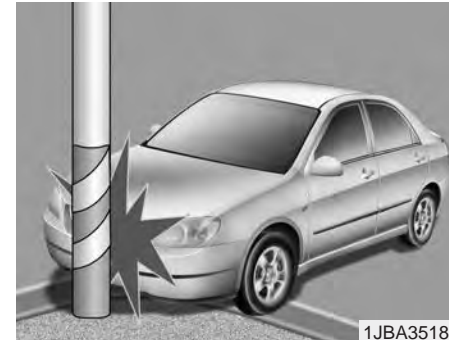

- Air bags may not inflate if the vehicle collides with objects such as utility poles or trees, where the point of impact is concentrated to one area and the full force of the impact is not delivered to the sensors.

FarmaSOS.com

SRS Care

The SRS is virtually maintenance-free and there are no parts you can safely service by yourself. If the SRS air bag warning light does not illuminate, or continuously remains on, have your vehicle immediately inspected by an authorized Kia dealer.

Any work on the SRS system, such as removing, installing, repairing, or any work on the steering wheel must be performed by an authorized Kia dealer. Improper handling of the SRS system may result in serious personal injury.

For cleaning the air bag pad covers, use only a soft, dry cloth or one which has been moistened with plain water. Solvents or cleaners could adversely affect the air bag covers and proper deployment of the system.

**WARNING - Tampering with SRS**

Do not tamper with or disconnect SRS wiring, or other components of the SRS system. Doing so could result in the accidental inflation of the air bags or by rendering the SRS inoperative.

If components of the air bag system must be discarded, or if the vehicle must be scrapped, certain safety precautions must be observed. An authorized Kia dealer knows these precautions and can give you the necessary information. Failure to follow these precautions and procedures could increase the risk of personal injury.

Adding equipment to or modifying your air bag-equipped vehicle

If you modify your vehicle by changing your vehicle's frame, bumper system, front end or side sheet metal or ride height, this may affect the operation of your vehicle's air bag system.

Air bag warning label

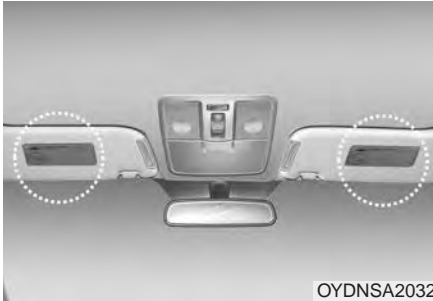

Air bag warning labels, some required by the Canada Motor Vehicle Safety Standards (CMVSS), are attached to the sunvisor to alert the driver and passengers of potential risks of the air bag system.

امداد خودرو فارما

تلفن شبانه روزی: ۰۲۱-۸۸۸۶۲۰۸۵

FarmaSOS.com

Features of your vehicle

Keys	4-4	• Emergency trunk safety release	4-23
• Record your key number	4-4	Windows	4-24
• Key operations	4-4	• Power windows	4-25
Smart key	4-6	Hood	4-29
• Smart key function	4-6	• Opening the hood	4-29
• Precautions	4-7	• Closing the hood	4-30
Remote keyless entry	4-9	Fuel filler lid	4-31
• Remote keyless entry system operations	4-9	• Opening the fuel filler lid	4-31
• Transmitter precautions	4-10	• Closing the fuel filler lid	4-31
• Battery replacement	4-11	Sunroof	4-34
• Immobilizer system	4-12	• Sunroof open warning	4-34
Theft-alarm system	4-15	• Sliding the sunroof	4-35
• Armed stage	4-15	• Tilting the sunroof	4-36
• Theft-alarm stage	4-16	• Sunshade	4-36
• Disarmed stage	4-16	• Resetting the sunroof	4-37
Door locks	4-18	Steering wheel	4-38
• From outside	4-18	• Electronic power steering	4-38
• From inside	4-18	• Tilt & telescopic steering	4-39
• Impact sensing door unlock system	4-20	• Horn	4-39
• Auto door lock/unlock feature	4-20	• Heated steering wheel	4-40
• Speed sensing door lock system	4-21	• FLEX STEER	4-40
• Child-protector rear door lock	4-21	Mirrors	4-43
Trunk	4-22	• Inside rearview mirror	4-43
• Opening the trunk	4-22	• Outside rearview mirror	4-48
• Closing the trunk	4-23		

Instrument cluster	4-52	Rearview camera	4-92
• Instrument Cluster Control	4-53	Lighting	4-93
• LCD Display Control	4-54	• Battery saver function.	4-93
• Gauges	4-54	• Headlamp escort function.	4-93
• Transaxle Shift Indicator	4-57	• Daytime running light.	4-94
LCD display	4-58	• Lighting control.	4-94
• LCD Modes	4-58	• High - beam operation	4-96
• Service Mode	4-59	• Turn signals and lane change signals	4-97
• User Settings Mode	4-60	• Front fog light	4-98
• A/V Mode	4-63	Wipers and washers	4-99
• Turn By Turn Mode	4-63	• Windshield wipers.	4-99
• Warning Messages.	4-64	• Windshield washers.	4-99
Trip computer	4-71	Interior light	4-101
• Overview	4-71	• Automatic turn off function	4-101
• Fuel Economy	4-72	• Map lamp	4-101
• Trip A/B	4-73	• Room lamp	4-102
Warning and indicator lights	4-75	• Trunk room lamp	4-103
• Warning lights	4-75	• Glove box lamp	4-103
• Indicator Lights.	4-81	• Vanity mirror lamp	4-104
Parking assist system	4-86	Welcome system	4-105
• Operation	4-87	• Headlamp welcome	4-105
• Non-operational conditions	4-89	• Interior light.	4-105
• Self-diagnosis	4-91	• Puddle lamp and pocket lamp	4-105
		Defroster	4-106
		• Rear window defroster	4-106

• Front wiper deicer	4-106	• Seat warmer	4-137
Manual climate control system	4-107	• Climate control seat	4-139
• Heating and air conditioning	4-108	• Power outlet	4-140
• System operation	4-113	• LCD monitor	4-141
• Climate control air filter	4-115	• Clothes hanger	4-142
• Refrigerant and compressor lubricant	4-116	• Floor mat anchor(s)	4-142
Automatic climate control system	4-117	• Navigation system	4-143
• Automatic heating and air conditioning	4-118	Audio system	4-144
• Manual heating and air conditioning	4-119	• Glass antenna	4-144
• System operation	4-125	• Steering wheel audio control	4-145
Windshield defrosting and defogging	4-127	• Aux, USB and iPod® port	4-146
• Manual climate control system	4-127		
• Automatic climate control system	4-128		
• Defogging logic	4-129		
Storage compartment	4-132		
• Center console storage	4-132		
• Glove box	4-132		
• Cool box	4-133		
• Sunglass holder	4-133		
Interior features	4-135		
• Cigarette lighter	4-135		
• Ashtray	4-135		
• Cup holder	4-136		
• Sliding armrest	4-136		
• Sunvisor	4-137		

تلفن شبانه روزی: ۰۲۱-۸۸۸۶۰۸۵
 FarmaOS.com

KEYS

Record your key number



The key code number is stamped on the bar code tag attached to the key set. Should you lose your keys, this number will enable an authorized Kia dealer to duplicate the keys easily. Remove the bar code tag and store it in a safe place. Also, record the code number and keep it in a safe place (not in the vehicle).

Key operations



Type A

Used to start the engine, lock and unlock the doors.

⚠ WARNING - Aftermarket keys

Use only Kia original parts for the ignition key in your vehicle. If an aftermarket key is used, the ignition switch may not return to ON after START. If this happens, the starter will continue to operate causing possible fire due to excessive current in the wiring.

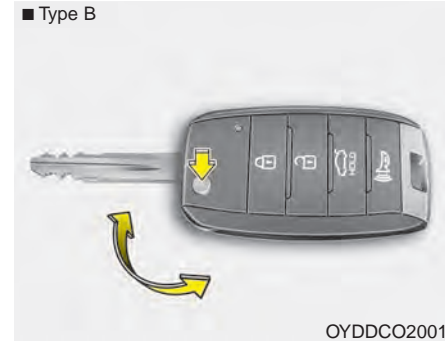

Type B

To unfold the key, press the release button and the key will unfold automatically.

To fold the key, fold the key manually while pressing the release button.

⚠ CAUTION - Key button operation

Do not fold the key without pressing the release button. This may damage the key.

■ Type C



Type C

To remove the mechanical key, press and hold the release button and remove the mechanical key.

To reinstall the mechanical key, put the key into the hole and push it until a click sound is heard.

امداد خودرو فارما

تلفن شبانه روزی: ۰۲۱-۸۸۸۶۲۰۸۵

FarmaSOS.com

SMART KEY (IF EQUIPPED)



OYDDCO2007

With a smart key, you can lock or unlock a door and even start the engine without inserting the key.

The functions of the buttons on a smart key are similar to the remote keyless entry. (Refer to the "Remote keyless entry" in this chapter.)

Smart key functions

Carrying the smart key, you may lock and unlock the vehicle doors. Also, you may start the engine. Refer to the following, for more details.

امداد خودرو فارما

تلفن شبانه روزی: ۰۲۱-۸۸۸۶۲۰۸۵

FarmaSOS.com

Locking

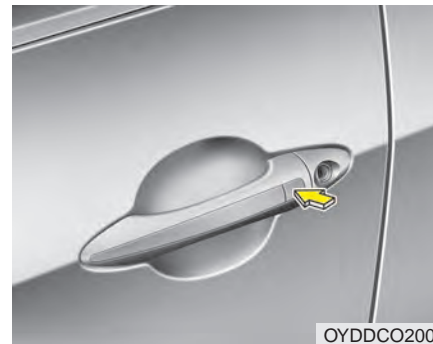

OYDDCO2008

Pressing the button of the front outside door handles with all doors closed and any door unlocked, locks all the doors. The hazard warning lights will blink and the chime will sound once to indicate that all doors are locked. The button will only operate when the smart key is within 0.7~1 m (28~40 in.) from the outside door handle. If you want to make sure that a door has locked or not, you should check the door lock button inside the vehicle or pull the outside door handle.

Even though you press the button, the doors will not lock and the chime will sound for 3 seconds if any of the following occurs:

- The smart key is in the vehicle.
- The ignition switch is in the ACC or ON position.
- Any door except the trunk is opened.

Unlocking

Pressing the button of the driver's outside door handle with all doors closed and locked, unlocks the driver's door. The hazard warning lights will blink and the chime will sound twice to indicate that the driver's door is unlocked.

Pressing the button in the front passenger's outside door handle with all doors closed and locked, unlocks all the doors. The hazard warning lights will blink and the chime will sound twice to indicate that all doors are unlocked. The button will only operate when the smart key is within 0.7~1 m (28~40 in.) from the outside door handle.

Start-up

You can start the engine without inserting the key. For detailed information refer to "Starting the engine with a smart key" in section 5.

Smart key precautions

- If you lose your smart key, you will not be able to start the engine. Tow the vehicle, if necessary, and contact an authorized Kia dealer.
- A maximum of 2 smart keys can be registered to a single vehicle. If you lose a smart key, you should immediately take the vehicle and key to your authorized Kia dealer to protect it from potential theft.
- The smart key will not work if any of following occurs:
 - The smart key is close to a radio transmitter such as a radio station or an airport which can interfere with normal operation of the smart key.
 - The smart key near a mobile two-way radio system or a cellular phone.
 - Another vehicle's smart key is being operated close to your vehicle.

When the smart key does not work correctly, open and close the door with the mechanical key. If you have a problem with the smart key, contact an authorized Kia dealer.

- If the smart key is in close proximity to your cell phone or smart phone, the signal from the smart key could be blocked by normal operation of your cell phone or smart phone. This is especially important when the phone is active such as making call, receiving calls, text messaging, and/or sending/receiving emails. Avoid placing the smart key and your cell phone or smart phone in the same pants or jacket pocket and maintain adequate distance between the two devices.



CAUTION - Transmitter

Keep the smart key away from water or any liquid as it can become damaged and not function properly.

This device complies with Industry Canada Standard RSS-210.

Operation is subject to the following two conditions:

1. This device may not cause harmful interference, and
2. This device must accept any interference received, including interference that may cause undesired operation.

*** NOTICE**

Changes or modifications not expressly approved by the party responsible for compliance could void the user's authority to operate the equipment. If the keyless entry system is inoperative due to changes or modifications not expressly approved by the party responsible for compliance, it will not be covered by your manufacturer's vehicle warranty.

REMOTE KEYLESS ENTRY (IF EQUIPPED)

Remote keyless entry system operations

■ Type A

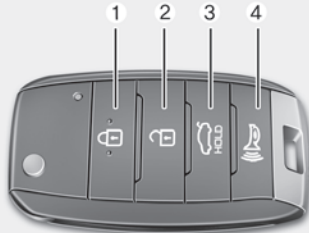

OYDDCO2003

■ Type B

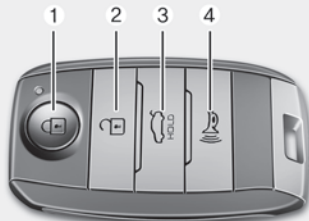

OYDDCO2004

Lock (1)

All doors are locked if the lock button is pressed. If all doors (and trunk) are closed, the hazard warning lights will blink once to indicate that all doors (and trunk) are locked.

Also, if the lock button is pressed once more within 4 seconds, the hazard warning lights will blink and the chime will sound once to confirm that the door is locked.

However, if any door remains open, the hazard warning lights (and/or the chime) will not operate. But if all doors are closed after the lock button is pressed, the hazard warning lights will blink once.

Unlock (2)

The driver's door is unlocked if the unlock button is pressed once. The hazard warning lights will blink (for smart key, the chime also sounds) twice to indicate that the driver's door is unlocked.

All doors are unlocked if the unlock button is pressed once more within 4 seconds. The hazard warning lights will blink (for smart key, the chime also sounds) twice again to indicate that all doors are unlocked. After pressing this button, the doors will lock automatically unless you open any door within 30 seconds.

*** NOTICE**

If the keyless entry system is inoperative due to exposure to water or liquids, it will not be covered by your manufacturer's vehicle warranty.

FarmaSOS.com

Trunk open (3) (if equipped)

The trunk is opened if the button is pressed for more than 1 second.

Once the trunk is opened and then closed, the trunk will lock automatically.

Alarm (4)

The horn sounds and the hazard warning lights blink for about 30 seconds if this button is pressed for more than 0.5 seconds. To stop the horn and lights, press any button on the transmitter.

Transmitter precautions

The transmitter (or smart key) will not work if any of following occurs:

- The ignition key is in the ignition switch.
- You exceed the operating distance limit (about 30 m [90 feet]).
- The battery in the transmitter (or smart key) is weak.
- Other vehicles or objects may be blocking the signal.
- The weather is extremely cold.
- The transmitter (or smart key) is close to a radio transmitter such as a radio station or an airport which can interfere with normal operation of the transmitter.

When the transmitter (or smart key) does not work properly, open and close the door with the ignition key. If you have a problem with the transmitter (or smart key), contact an authorized Kia dealer.

- If the transmitter is in close proximity to your cell phone or smart phone, the signal from the transmitter could be blocked by normal operation of your cell phone or smart phone. This is especially important when the phone is active such as making call, receiving calls, text messaging, and/or sending/receiving emails. Avoid placing the transmitter and your cell phone or smart phone in the same pants or jacket pocket and maintain adequate distance between the two devices.

This device complies with Industry Canada Standard RSS-210.

Operation is subject to the following two conditions:

1. This device may not cause harmful interference, and
2. This device must accept any interference received, including interference that may cause undesired operation.

*** NOTICE**

Changes or modifications not expressly approved by the party responsible for compliance could void the user's authority to operate the equipment. If the keyless entry system is inoperative due to changes or modifications not expressly approved by the party responsible for compliance, it will not be covered by your manufacturer's vehicle warranty.

Battery replacement



A battery should last for several years, but if the transmitter or smart key is not working properly, try replacing the battery with a new one. If you are unsure how to use or replace the battery, contact an authorized Kia dealer.

Type A

1. Pry open the transmitter cover.
2. Replace the battery with a new battery (CR2032). When replacing the battery, make sure the battery position.
3. Install the battery in the reverse order of removal.

Type B

1. Remove the mechanical key.
2. Pry open the rear cover.
3. Replace the battery with a new battery (CR2032). When replacing the battery, make sure the battery position.
4. Install the battery in the reverse order of removal.

- The transmitter or smart key is designed to give you years of trouble-free use, however it can malfunction if exposed to moisture or static electricity. If you are unsure how to use or replace the battery, contact an authorized Kia dealer.
- Using the wrong battery can cause the transmitter or smart key to malfunction. Be sure to use the correct battery.
-  An inappropriately disposed battery can be harmful to the environment and human health. Dispose the battery according to your local law(s) or regulation.

 **CAUTION - Transmitter damage**

Do not drop, wet or expose the keyless entry system transmitter to heat or sunlight.

 **IC WARNING**

This device complies with Industry Canada licence-exempt RSS standard(s).

Operation is subject to the following two conditions: (1) this device may not cause interference, and (2) this device must accept any interference, including interference that may cause undesired operation of the device.

تلفن شبانه روزی: ۰۲۱-۸۸۶۲۰۸۵

FarmaSOS.com

Immobilizer system



Your vehicle may be equipped with an electronic engine immobilizer system to reduce the risk of unauthorized vehicle use.

Your immobilizer system is comprised of a small transponder in the ignition key and electronic devices inside the vehicle.

With the immobilizer system, whenever you insert your ignition key into the ignition switch and turn it to ON, it checks and determines and verifies that the ignition key is valid.

If the key is determined to be valid, the engine will start.

If the key is determined to be invalid, the engine will not start.

To deactivate the immobilizer system:

Insert the ignition key into the key cylinder and turn it to the ON position.

To activate the immobilizer system:

Turn the ignition key to the OFF position. The immobilizer system activates automatically. Without a valid ignition key for your vehicle, the engine will not start.

Your Immobilizer password is a customer unique password and should be kept confidential. Do not leave this number anywhere in your vehicle.

*** NOTICE**

Keep each key separately in order to avoid a starting malfunction.

Do not put metal accessories near the ignition switch.

Metal accessories may interrupt the transponder signal and may prevent the engine from being started.

If you need additional keys or lose your keys, consult an authorized Kia dealer.

 **CAUTION - Immobilizer damage**

Do not expose your immobilizer system to moisture, static electricity and rough handling. This may damage your immobilizer.

 **CAUTION - Immobilizer alterations**

Do not change, alter or adjust the immobilizer system because it could cause the immobilizer system to malfunction.

This device complies with Industry Canada Standard RSS-210.

Operation is subject to the following two conditions:

1. This device may not cause harmful interference, and
2. This device must accept any interference received, including interference that may cause undesired operation.

 **WARNING**

Changes or modifications not expressly approved by the party responsible for compliance could void the user's authority to operate the equipment.

Limp home (override) procedure

When you turn the ignition switch to the ON position, if the immobilizer indicator () goes off after blinking 5 times, your transponder equipped in the ignition key is out of order. You cannot start the engine without the limp home procedure. To start the engine, you have to input your password by using the ignition switch. Your password is only available from an authorized Kia dealership. Contact an authorized dealer for more information.

The following procedure is how to input your password of "2345" as an example.

1. Turn the ignition switch to the ON position. The immobilizer indicator () will blink 5 times and go off indicating the beginning of the limp home procedure.
2. Turn the ignition switch to the ACC position.

3. To enter the first digit (in this example "2"), turn the ignition switch to the ON and ACC position twice. Perform the same procedure for the next digits between 3 seconds and 10 seconds (for example, for "3", turn the ignition ON and ACC 3 times).
4. If all of the digits have been input successfully, you have to start the engine within 30 seconds. If you attempt to start the engine after 30 seconds, the engine will not start and you will have to input your password again.

After performing the limp home procedure, you have to see an authorized Kia dealer immediately to inspect and repair your ignition key or immobilizer system.

THEFT-ALARM SYSTEM (IF EQUIPPED)

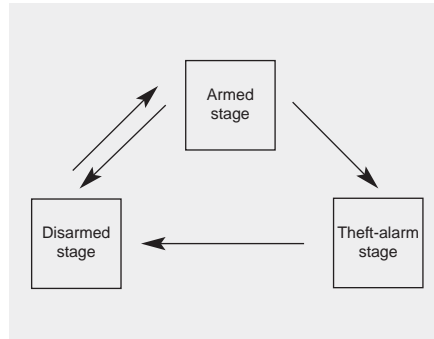

This system is designed to provide protection from unauthorized entry into the vehicle. This system is operated in three stages: the first is the "Armed" stage, the second is the "Theft-alarm" stage, and the third is the "Disarmed" stage. If triggered, the system provides an audible alarm with blinking of the hazard warning lights.

Armed stage

Park the vehicle and stop the engine. Arm the system as described below.

1. Remove the ignition key from the ignition switch and exit the vehicle.
2. Make sure that all doors (and trunk) and engine hood are closed and latched.
3. Lock the doors by depressing the door lock button on the transmitter (or smart key).

After completion of the steps above, the hazard warning lights will blink once to indicate that the system is armed.

If any door, trunk or engine hood remains open, the hazard warning lights won't operate and theft-alarm will not arm. After this, if all doors, trunk and engine hood are closed, the hazard warning lights blink once.

- Lock the doors by pressing the button of the front outside door handles with the smart key in your possession.

After completion of the steps above, the hazard warning lights will blink once to indicate that the system is armed.

If any door remains open, the hazard warning lights won't operate and theft-alarm will not arm. Close the door and try again to lock the doors.

If trunk or engine hood remains open, the hazard warning lights won't operate and theft-alarm will not arm. Close the trunk or engine hood. The hazard warning lights blink once and theft-alarm arms.

The theft-alarm system can be activated by an authorized Kia dealer. If you want this feature, consult an authorized Kia dealer.

Do not arm the system until all passengers have left the vehicle. If the system is armed while a passenger(s) remains in the vehicle, the alarm may be activated when the remaining passenger(s) leaves the vehicle. If any door (or trunk) or engine hood is opened within 30 seconds after the system enters the armed stage, the system will be disarmed to prevent unnecessary alarm.

Theft-alarm stage

The alarm will be activated if any of the following occurs while the system is armed.

- A front or rear door is opened without using the mechanical key or transmitter (or smart key).
- The trunk is opened without using the mechanical key or transmitter (or smart key).
- The engine hood is opened.

The horn will sound and the hazard warning lights will blink continuously for approximately 27 seconds (2times). To turn off the system, unlock the doors with the transmitter (or smart key).

FarmaSOS.com

Disarmed stage

The system will be disarmed when:

Transmitter

- The door unlock button is pressed.
- The engine is started. (within 3 seconds)
- The ignition switch is in the "ON" position for 30 seconds or more.

Smart key

- The door unlock button is pressed.
- The button of the front outside door is pressed while carrying the smart key.
- The engine is started. (within 3 seconds)

After the doors are unlocked, the hazard warning lights will blink twice to indicate that the system is disarmed.

After pressing the unlock button, if any door (or trunk) is not opened within 30 seconds, the system will be rearmed.

- Avoid trying to start the engine while the alarm is activated. The vehicle starting motor is disabled during the theft-alarm stage.

If the system is not disarmed with the transmitter, insert the key into the ignition switch, turn the ignition switch to the ON position and wait for 30 seconds. Then the system will be disarmed.

- If you lose your keys, consult your authorized Kia dealer.
- If the system is not disarmed with the transmitter, insert the key into the ignition switch and start the engine. Then the system will be disarmed.
- If you lose your keys, consult your authorized Kia dealer.

امداد خودرو فارما

تلفن شبانه روزی: ۰۲۱-۸۸۸۶۲۰۸۵

FarmaSOS.com

DOOR LOCKS

Operating door locks from outside the vehicle

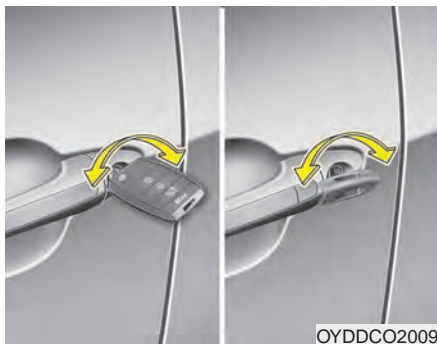

- Turn the key toward the rear of the vehicle to unlock and toward the front of the vehicle to lock.
- If you lock/unlock the door with a key, all vehicle doors will lock/unlock automatically. (if equipped with power door locks)
- From the driver's door, turn the key toward the rear of the vehicle once to unlock the driver's door and once more within 4 seconds to unlock all doors. (if equipped with power door locks)

- Doors can also be locked and unlocked with the transmitter key (or smart key). (if equipped)
- Once the doors are unlocked, they may be opened by pulling the door handle.
- When closing the door, push the door by hand. Make sure the doors are closed securely.

* NOTICE

- In cold and wet climates, door lock and door mechanisms may not work properly due to freezing conditions.
- If the door is locked/unlocked multiple times in rapid succession with either the vehicle key or door lock switch, the system may stop operating temporarily in order to protect the circuit and prevent damage to system components.

Operating door locks from inside the vehicle

With the door lock button

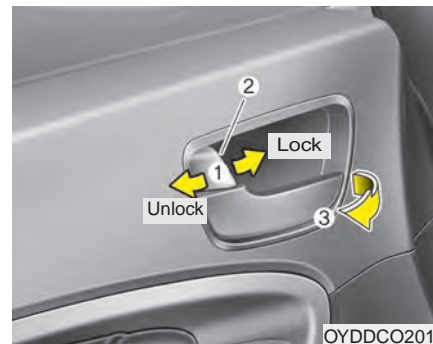

- To unlock a door, pull the door lock button (1) to the "Unlock" position. The red mark (2) on the button will be visible.
- To lock a door, push the door lock button (1) to the "Lock" position. If the door is locked properly, the red mark (2) on the door lock button will not show.
- To open a door, pull the door handle (3) outward.

- If the inner door handle of the front door is pulled when the door lock button is in the lock position, the button will unlock and the door will open. (if equipped)
- Front doors cannot be locked if the ignition key is in the ignition switch (or if the smart key is in the vehicle) and any front door is opened. (if equipped)

If a power door lock ever fails to function while you are in the vehicle, try one or more of the following techniques to exit:

- Operate the door unlock feature repeatedly (both electronic and manual) while simultaneously pulling on the door handle.
- Operate the other door locks and handles, front and rear.
- Lower a front window and use the key to unlock the door from outside.

تلفن شبانه روزی: ۰۲۱-۸۸۸۶۲۰۸۵

FarmaSOS.com

With central door lock switch (if equipped)

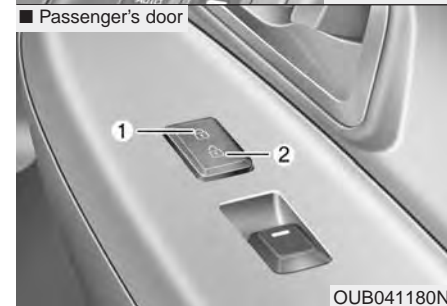

Operate by pressing the central door lock switch.

- Press the switch to the "Lock" position (1), all vehicle doors will lock.
- Press the switch to the "Unlock" position (2), all vehicle doors will unlock.
- If the key is in the ignition switch (or if the smart key is in the vehicle) and any front door is opened, the doors will not lock when the "Lock" position (1) of the central door lock switch is pressed. (if equipped)

⚠ WARNING - Doors

The doors should always be fully closed and locked while the vehicle is in motion to prevent accidental opening of the door.

⚠ WARNING - Unattended children / animals

Never leave children or animals unattended in your vehicle.

An enclosed vehicle can become extremely hot, causing death or severe injury to unattended children or animals who cannot escape the vehicle.

Impact sensing door unlock system (if equipped)

All doors will automatically unlock when an impact causes the air bags to deploy.

Auto door lock/unlock feature (if equipped)

- All doors will automatically lock when the transaxle shift lever is shifted out of P (Park).
- All doors will automatically unlock when the transaxle shift lever is shifted into P (Park).

Speed sensing door lock system (if equipped)

All doors will be automatically locked after the vehicle speed exceeds 9.3 mph. And all doors will be automatically unlocked when you turn the engine off or when you remove the ignition key. (if equipped)

An authorized Kia dealer can activate or deactivate some auto door lock/ unlock features as follows;

- Auto door unlock by using the driver's door lock button
- Auto door lock/unlock by shifting the transaxle shift lever out of P (Park) or into P (Park)
- Auto door unlock when the ignition key is removed from the ignition switch (for smart key, when the ENGINE START/STOP button is turned to the OFF position)

If you want to activate or deactivate some door lock/unlock feature, consult an authorized Kia dealer.

Child-protector rear door lock

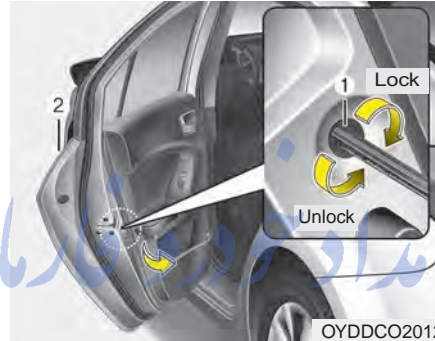

The child safety lock is provided to help prevent children from accidentally opening the rear doors from inside the vehicle. The rear door safety locks should be used whenever children are in the vehicle.

1. Open the rear door.
2. Insert a key (or screwdriver) into the hole and turn it to the lock (🔒) position. the child safety lock (1) located on the rear edge of the door to the lock position. When the child safety lock is in the lock position, rear door will not open even when the inner door handle is pulled.

3. Close the rear door.

To open the rear door, pull the outside door handle (2).

Even though the doors may be unlocked, the rear door will not open by pulling the inner door handle until the rear door child safety lock is unlocked.

TRUNK

Opening the trunk

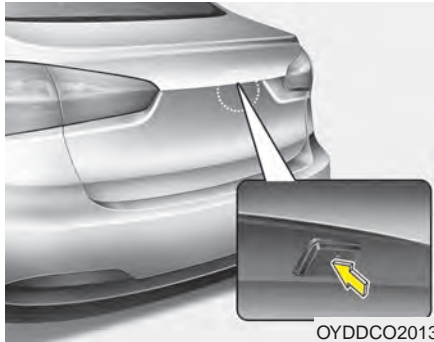

- Press the trunk unlock button for more than 1 second on the transmitter (or smart key).
- Press the button on the trunk handle with the smart key in your possession.

Once the trunk is opened and then closed, the trunk locks automatically.



- To open the trunk from inside the vehicle, pull the trunk lid release lever.
Once the trunk is opened and then closed, the trunk locks automatically.

* NOTICE

In cold and wet climates, trunk lock and trunk mechanisms may not work properly due to freezing conditions.

⚠ WARNING

The trunk swings upward. Make sure no objects or people are near the rear of the vehicle when opening the trunk.

⚠ CAUTION

Make certain that you close the trunk before driving your vehicle. Possible damage may occur to attached hardware if the trunk is not closed prior to driving.

Closing the trunk

To close, lower the trunk lid, then press down on it until it locks. To be sure the trunk lid is securely fastened, always check by trying to pull it up again.

⚠ WARNING

The trunk lid should always be kept completely closed while the vehicle is in motion. If it is left open or ajar, poisonous exhaust gases may enter the car and serious illness or death may result.

Emergency trunk safety release



Your vehicle is equipped with an emergency trunk release lever located inside the trunk. If someone is inadvertently locked in the trunk, moving the handle in the direction of the arrow will release the trunk latch mechanism and open the trunk.

⚠ WARNING

- No one should be allowed to occupy the trunk at any time. The trunk is a very dangerous location in the event of a crash.
- Use the release lever for emergencies only. Use extreme caution, especially while the vehicle is in motion.

In cold and wet climates, power windows may not work properly due to freezing conditions.

Power windows

The ignition switch must be in the ON position for power windows to operate. Each door has a power window switch that controls the door's window. The driver has a power window lock switch which can block the operation of passenger windows.

The power windows can be operated for approximately 30 seconds after the ignition key is removed or turned to the ACC or LOCK position. However, if the front doors are opened, the power windows cannot be operated even within the 30 second period.

* NOTICE

While driving with the rear windows down or with the sunroof (if equipped) in an open (or partially open) position, your vehicle may demonstrate a wind buffeting or pulsation noise. This noise is a normal occurrence and can be reduced or eliminated by taking the following actions. If the noise occurs with one or both of the rear windows down, partially lower both front windows approximately one inch. If you experience the noise with the sunroof open, slightly reduce the size of the sunroof opening.

تلفن شبانه روزی: ۰۲۱-۸۸۸۸۸۸۸۸

FarmaSOS.com

Window opening and closing (if equipped)



OYDDCO2017

The driver's door has a master power window switch that controls all the windows in the vehicle.

To open or close a window, press down or pull up the front portion of the corresponding switch to the first detent position (5).

Auto down window (if equipped) (Driver's window)



Pressing the power window switch momentarily to the second detent position (6) completely lowers the driver's window even when the switch is released. To stop the window at the desired position while the window is in operation, momentarily pull up the switch to the opposite direction of the window movement.

Auto up/down window (if equipped)



Pressing or pulling up the power window switch momentarily to the second detent position (6) completely lowers or lifts the window even when the switch is released. To stop the window at the desired position while the window is in operation, pull up or press and release the switch to the opposite direction of the movement. If the power window is not operated correctly, the automatic power window system must be reset as follows:

1. Turn the ignition switch to the ON position.
2. Close the window and continue pulling up on the driver's power window switch for at least 1 second after the window is completely closed.

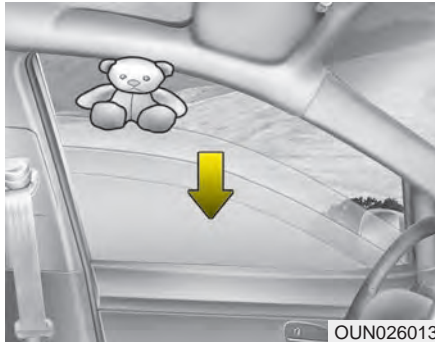

OUN026013

Automatic reversal

If the upward movement of the window is blocked by an object or part of the body, the window will detect the resistance and will stop upward movement. The window will then lower approximately 30 cm (11.8 in.) to allow the object to be cleared.

If the window detects the resistance while the power window switch is pulled up continuously, the window will stop upward movement then lower approximately 2.5 cm (1 in.).

And if the power window switch is pulled up continuously again within 5 seconds after the window is lowered by the automatic window reversal feature, the automatic window reversal will not operate.

The automatic reverse feature for the driver's window is only active when the "auto up" feature is used by fully pulling up the switch. The automatic reverse feature will not operate if the window is raised using the halfway position on the power window switch.

⚠ WARNING

Always check for obstructions before raising any window to avoid injuries or vehicle damage. If an object less than 4 mm (0.16 in.) in diameter is caught between the window glass and the upper window channel, the automatic reverse window may not detect the resistance and will not stop and reverse direction.

Power window lock button (if equipped)



OYDDCO2019

The driver can disable the power window switches on the rear passengers' doors by pressing the power window lock switch to the lock position (pressed).

When the power window lock switch is pressed:

- The driver's master control can operate all the power windows.
- The front passenger's control can operate the front passenger's power window.
- The rear passenger's control cannot operate the rear passenger's power window.

 **CAUTION - Opening / closing Window**

To prevent possible damage to the power window system, do not open or close two windows or more at the same time. This will also ensure the longevity of the fuse.

 **WARNING - Power windows**

Do not allow children to play with the power windows. Keep the driver's door power window lock switch in the LOCK position (pressed).

Always double check to make sure all arms, hands, head and other obstructions are safely out of the way before closing a window.

امداد خودرو فارما

تلفن شبانه روزی: ۰۲۱-۸۸۸۶۲۰۸۵

FarmaSOS.com

HOOD

Opening the hood

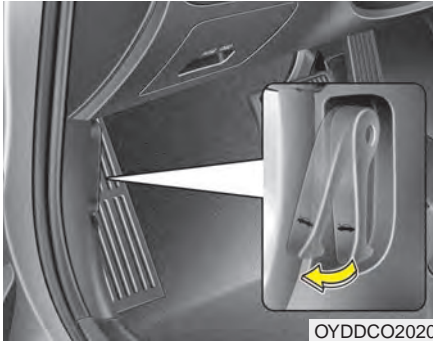

1. Pull the release lever to unlatch the hood. The hood should pop open slightly.

Open the hood after turning off the engine on a flat surface, shifting the shift lever to the P(Park) position for automatic transaxle and to the 1st(First) gear or R(Reverse) for manual transaxle, and setting the parking brake.



2. Go to the front of the vehicle, raise the hood slightly, push the secondary latch (1) left side and lift the hood (2).
3. Raise the hood. It will raise completely by itself after it has been raised about halfway.

⚠ WARNING

- Always double check to be sure that the hood is firmly latched before driving away. If it is not latched, the hood could fly open while the vehicle is being driven, causing a total loss of visibility, which might result in an accident.
- Do not move the vehicle with the hood raised. The view will be blocked and the hood could fall or be damaged.

Closing the hood

1. Before closing the hood, check the following:
 - All filler caps in the engine compartment must be correctly installed.
 - Gloves, rags or any other combustible material must be removed from the engine compartment.
2. Return the support rod to its clip to prevent it from rattling.
3. Lower the hood until it is about 30 cm (1 ft.) above the closed position and let it drop. Make sure that it locks into place.

⚠ WARNING - Fire risk

Do not leave gloves, rags or any other combustible material in the engine compartment. Doing so may cause a heat-induced fire.

⚠ WARNING - Unsecured engine Hood

If the engine hood is not secured properly, it is likely to fly up blocking your vision and causing a crash.

The support rod must be inserted completely into the hole whenever you inspect the engine compartment. This will prevent the hood from falling and possibly injuring you.

تلفن شبانه روزی: ۰۲۱-۸۸۸۶۲۰۸۵

FarmaSOS.com

FUEL FILLER LID

Opening the fuel filler lid

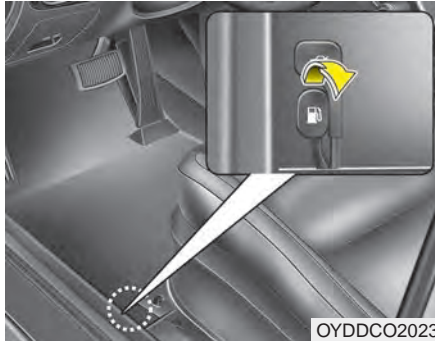

The fuel filler lid must be opened from inside the vehicle by pulling up the fuel filler lid opener.

If the fuel filler lid does not open because ice has formed around it, tap lightly or push on the lid to break the ice and release the lid. Do not pry on the lid. If necessary, spray around the lid with an approved de-icer fluid (do not use radiator anti-freeze) or move the vehicle to a warm place and allow the ice to melt.

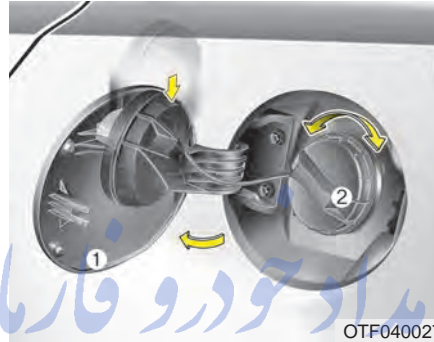

1. Stop the engine.
2. To open the fuel filler lid, pull the fuel filler lid opener up.
3. Pull open the fuel filler lid (1) out to fully open.
4. To remove the cap turn the fuel filler cap (2) counterclockwise.
5. Refuel as needed.

Closing the fuel filler lid

1. To install the cap, turn it clockwise until it "clicks" once. This indicates that the cap is securely tightened.
2. Close the fuel filler lid and push it lightly and make sure that it is securely closed.

⚠ WARNING - Refueling

Always remove the fuel cap carefully and slowly. If the cap is venting fuel or if you hear a hissing sound, wait until the condition stops before completely removing the cap.

If pressurized fuel sprays out, it can cover your clothes or skin and subject you to the risk of fire and burns.

Always check that the fuel cap is installed securely to prevent fuel spillage in the event of an accident.

**⚠ WARNING - Fire /
explosion risk**

Read and follow all warnings posted at the gas station facility. Failure to follow all warnings will result in severe personal injury, severe burns or death due to fire or explosion.

**⚠ WARNING - Static
electricity**

- Before touching the fuel nozzle, you should eliminate potentially dangerous static electricity discharge by touching another metal part of the vehicle, a safe distance away from the fuel filler neck, nozzle, or other gas source.
- Do not get back into a vehicle once you have begun refueling since you can generate static electricity by touching, rubbing or sliding against any item or fabric (polyester, satin, nylon, etc.) capable of producing static electricity. Static electricity discharge can ignite fuel vapors resulting in rapid burning. If you must re-enter the vehicle, you should once again eliminate potentially dangerous static electricity discharge by touching a metal part of the vehicle, away from the fuel filler neck, nozzle or other gasoline source.

*** NOTICE**

When using an approved portable fuel container, be sure to place the container on the ground prior to refueling. Static electricity discharge from the container can ignite fuel vapors causing a fire. Once refueling has begun, contact with the vehicle should be maintained until the filling is complete. Use only approved portable plastic fuel containers designed to carry and store gasoline.

**⚠ WARNING - Cell phone
fires**

Do not use cellular phones while refueling. Electric current and/or electronic interference from cellular phones can potentially ignite fuel vapors causing a fire.

⚠ WARNING - Refueling & Vehicle fires

When refueling, always shut the engine off. Sparks produced by electrical components related to the engine can ignite fuel vapors causing a fire. Once refueling is complete, check to make sure the filler cap and filler door are securely closed, before starting the engine.

⚠ WARNING - Smoking

DO NOT use matches or a lighter and DO NOT SMOKE or leave a lit cigarette in your vehicle while at a gas station especially during refueling. Automotive fuel is highly flammable and can, when ignited, result in fire.

Make sure to refuel your vehicle according to the "Fuel requirements" suggested in chapter 1.

If the fuel filler cap requires replacement, use only a genuine Kia cap or the equivalent specified for your vehicle. An incorrect fuel filler cap can result in a serious malfunction of the fuel system or emission control system.

⚠ CAUTION - Exterior paint

Do not spill fuel on the exterior surfaces of the vehicle. Any type of fuel spilled on painted surfaces may damage the paint.

FarmaSOS.com

SUNROOF (IF EQUIPPED)

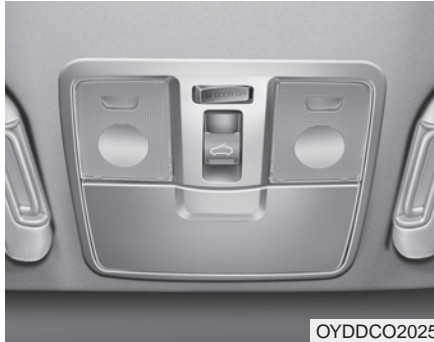

If your vehicle is equipped with a sunroof, you can slide or tilt your sunroof with the sunroof control lever located on the overhead console.

The sunroof can only be opened, closed, or tilted when the ignition switch is in the ON position.

In cold and wet climates, the sunroof may not work properly due to freezing conditions.

After the vehicle is washed or in a rainstorm, be sure to wipe off any water that is on the sunroof before operating it.

The sunroof cannot slide when it is in the tilt position nor can it be tilted while in an open or slide position.

CAUTION - Sunroof control lever

Do not continue to press the sunroof control lever after the sunroof is fully opened, closed, or tilted. Damage to the motor or system components could occur.

WARNING - Sunroof operation

When closing the sunroof, make sure there are no body parts in the movement range of the sliding roof. Parts of the body could become trapped or crushed.

Sunroof open warning (if equipped)

■ Type A



OYDDDI2016

■ Type B



OYDNDI2030

■ Type C



OYDNDI2052

If the driver removes the ignition key (smart key: turns off the engine) and opens the driver-side door when the sunroof is not fully closed, the warning chime will sound for a few seconds and a warning image will appear on the LCD display.

Close the sunroof securely when leaving your vehicle.

Sliding the sunroof

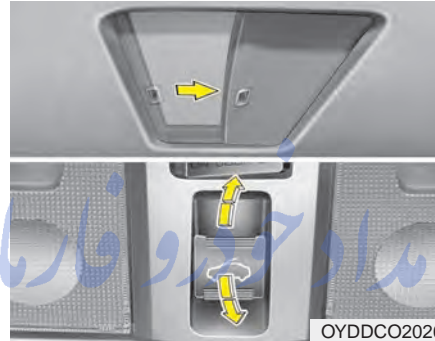

To open the sunroof automatically:

Pull the sunroof control lever backward to the second detent position and then release it. The sunroof will slide all the way open.

The sunroof will slide to the recommended open position (about 5 cm (2in.) before the maximum slide open position).

To stop the sunroof sliding at any point, pull or push the sunroof control lever momentarily.

To open the sunroof to the maximum slide open position, press the switch towards the rear of the vehicle once again and hold it until the sunroof slide all the way open.

To reduce wind noise while driving, we recommend you to drive at the recommended position (about 5 cm (2in.) before the maximum slide open position).

To close the sunroof automatically:

Push the sunroof control lever forward to the second detent position and then release it. The sunroof will automatically close all the way.

To stop the sunroof sliding at any point, pull or push the sunroof control lever momentarily.

While driving with the sunroof in an open (or partially open position), your vehicle may demonstrate a wind buffeting or pulsation noise. This noise is a normal occurrence and can be reduced or eliminated by taking the following actions. If you experience the noise with the sunroof open, slightly reduce the size of the sunroof opening.

Automatic reversal

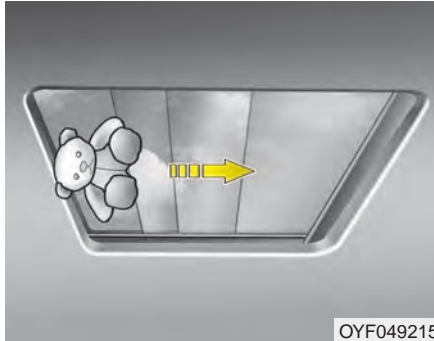

If an object or part of the body is detected while the sunroof glass or sunshade is closing automatically, it will reverse the direction, and then stop.

The auto reverse function does not work if a tiny obstacle is between the sliding glass or sunshade and the sunroof sash. You should always check that all passengers and objects are away from the sunroof before closing it.

Tilting the sunroof



To open the sunroof, push the sunroof control lever upward until the sunroof moves to the desired position.

To close the sunroof, push the sunroof lever forward or pull downward until the sunroof moves to the desired position.

CAUTION - Sunroof motor damage

If you try to open the sunroof when the temperature is below freezing or when the sunroof is covered with snow or ice, the glass or the motor could be damaged.

Sunshade



When opening the sunroof, the sunshade will also open. Once the sunroof is closed, the sunshade can be manually closed.

Resetting the sunroof

Whenever the vehicle battery is disconnected or discharged, or related fuse is blown, you must reset your sunroof system as follows:

1. Turn the ignition switch to the ON position or start the engine. We recommend resetting the sunroof while the engine is running.
2. Push and release the control lever forward in the direction of close repeatedly until the sunroof does not move. Sunroof will stop at the close position or the tilt position depends on the sunroof condition.
3. Release the control lever when sunroof does not move.

4. Push the control lever forward in the direction of close about 10 seconds.

- When the sunroof is in the close position :

Glass will tilt up then will move up and down slightly.

- When the sunroof is in the tilt position:

Glass will move up and down slightly.

5. Within 3 seconds, push the sunroof control lever forward in the direction of close until the sunroof operates as follows:

Tilt down → Slide Open →
Slide Close.

* NOTICE

Do not release the lever until the operation is completed.
If you release the lever during operation, try again from step 2.

6. Release the sunroof control lever after all operation has completed. (The sunroof system has been reset.)

* For more detailed information, contact an authorized Kia dealer.

* NOTICE

If the sunroof is not reset when the vehicle battery is disconnected or discharged, or related fuse is blown, the sunroof may operate improperly.

STEERING WHEEL

Electric power steering (EPS)

Power steering uses the motor to assist you in steering the vehicle. If the engine is off or if the power steering system becomes inoperative, the vehicle may still be steered, but it will require increased steering effort.

The motor driven power steering is controlled by the power steering control unit which senses the steering wheel torque and vehicle speed to command the motor.

The steering wheel becomes heavier as the vehicle's speed increases and becomes lighter as the vehicle's speed decreases for better control of the steering wheel.

Should you notice any change in the effort required to steer during normal vehicle operation, have the power steering checked by an authorized Kia dealer.

* NOTICE

The following symptoms may occur during normal vehicle operation:

- The steering effort is increased immediately after turning the ignition switch on. This happens as the system performs the EPS system diagnostics. When the diagnostics are completed, the steering wheel will return to its normal condition
- A click noise may be heard from the EPS relay after the ignition switch is turned to the ON or LOCK position.
- Motor noise may be heard when the vehicle is at a stop or at a low driving speed.
- The steering effort increases if the steering wheel is rotated continuously when the vehicle is not in motion. However, after a few minutes, it will return to its normal condition.
- When you operate the steering wheel in low temperature, noise may occur. If the temperature rises, the noise will likely disappear. This is a normal condition.

If the Electric Power Steering System does not operate normally, the warning light will illuminate on the instrument cluster. The steering wheel may require increased steering effort. Take your vehicle to an authorized Kia dealer and have the vehicle checked as soon as possible.

Tilt and telescoping steering

Tilt steering allows you to adjust the steering wheel before you drive. You can also raise it to give your legs more room when you exit and enter the vehicle.

The steering wheel should be positioned so that it is comfortable for you to drive, while permitting you to see the instrument panel warning lights and gauges.

⚠ WARNING - Steering wheel adjustment

Never adjust the angle and height of the steering wheel while driving. You may lose steering control

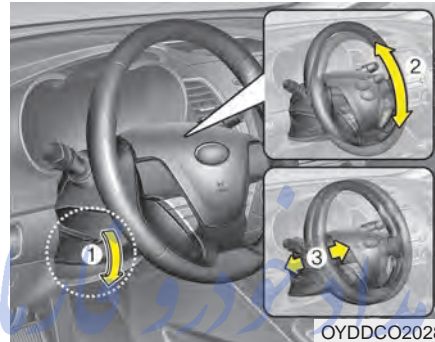

To change the steering wheel angle, pull down the lock release lever (1), adjust the steering wheel to the desired angle (2) and height (3), then pull up the lock-release lever to lock the steering wheel in place. Be sure to adjust the steering wheel to the desired position before driving.

Horn



To sound the horn, press the horn symbol on your steering wheel. Check the horn regularly to be sure it operates properly.

To sound the horn, press the area indicated by the horn symbol on your steering wheel (see illustration). The horn will operate only when this area is pressed.

Heated steering wheel (if equipped)



With the ignition switch in the ON position, pressing the heated steering wheel button warms the steering wheel. The indicator on the button will illuminate and notify you on the LCD display.

To turn the heated steering wheel off, press the button once again. The indicator on the button will turn off and notify you on the LCD display.

If you turn on the ignition again after turning off your engine in half an hour (after operating heater button), the heating system will be maintained in its 'on' condition.

⚠ CAUTION

- *Do not install any grip to operate the steering wheel. This causes damage to the heated steering wheel system.*
- *When cleaning the heated steering wheel, do not use an organic solvent such as paint thinner, benzene, alcohol and gasoline. Doing so may damage the surface of the steering wheel.*
- *If the surface of the steering wheel is damaged by a sharp object, damage to the heated steering wheel components could occur.*

FarmaSOS.com

FLEX STEER (if equipped)



The FLEX STEER controls steering effort based upon driver's preference or road condition.

You can select the desired steering mode by pressing the FLEX STEER button.

■ Type A

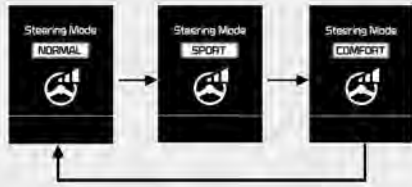

OYDECO2233

■ Type B



OYDECO2232

When the steering mode button is pressed, the selected steering mode will appear on the LCD display.

If the steering mode button is pressed within 4 seconds, the steering mode will change as shown above the pictures.

If the steering wheel mode button is not pressed for about 4 seconds, the LCD display will change to the previous screen.

Normal mode

■ Type A

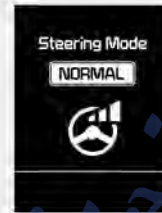

OYDDCO2204

■ Type B



OYDDCO2207

The normal mode offers medium steering effort.

Sport mode

■ Type A



OYDDCO2206

■ Type B



OYDDCO2208

The steering wheel becomes heavier. The sport mode is usually used when driving on the highway.

آرداد خودرو فارما
تلفن شبانه روزی: ۰۲۱-۸۸۶۱۰۵
FarmaSOS.com

Comfort mode

■ Type A



OYDDCO2205

■ Type B



OYDDCO2209

The steering wheel becomes lighter. The comfort mode is usually used when driving in the city or when parking the vehicle.

CAUTION

- *For your safety, if you press the steering mode button while operating the steering wheel, the LCD display will change, but steering effort will not change immediately. After operating the steering wheel, the steering effort will change automatically to the selected mode.*
- *Use caution when changing the steering mode while driving.*
- *When the electronic power steering is not operating, the flex steering wheel will not work.*

FarmaSOS.com

MIRRORS

Inside rearview mirror

Adjust the rearview mirror so that the center view through the rear window is seen. Make this adjustment before you start driving.

Do not place objects in the rear seat which would interfere with your vision through the rear window.

⚠ WARNING - Mirror adjustment
Do not adjust the rearview mirror while the vehicle is moving. This could result in loss of control.

Day/night rearview mirror (if equipped)



Make this adjustment before you start driving and while the day/night lever is in the day position.

Pull the day/night lever toward you to reduce the glare from the headlights of the vehicles behind you during night driving.

Remember that you lose some rearview clarity in the night position.

Electric chromic mirror with homelink® system (if equipped)

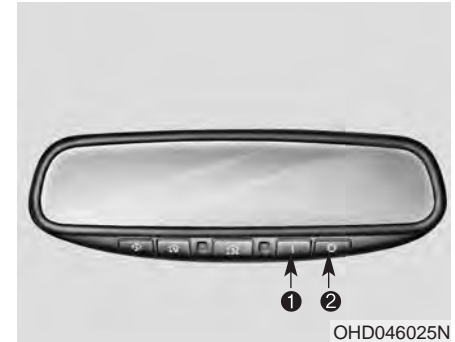

To operate the electric rearview mirror

Press the I button (1) to turn the automatic- dimming function on. The mirror indicator light will illuminate.

Press the O button (2) to turn the automatic- dimming function off. The mirror indicator light will turn off.

* HomeLink® is a registered trademark of Johnson Controls, Inc.

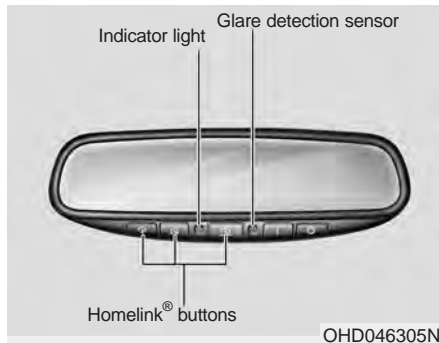

HomeLink®: Wireless Control System

Your new mirror comes with an integrated Homelink® Universal Transceiver, which allows you to program the mirror to activate your garage door(s), estate gate, home lighting, etc. The mirror actually learns the codes from your various existing transmitters.

⚠ WARNING

- **When programming the HomeLink® Wireless Control System, you may be operating a garage door or gate operator. Make sure that people and objects are out of the way of the moving door or gate to prevent potential harm or damage.**
- **Do not use HomeLink® with any garage door opener that lacks the safety stop and reverse feature as required by federal safety standards. (This includes any garage door opener model manufactured before April 1, 1982.) A garage door opener which cannot detect an object, signaling the door to stop and reverse, does not meet current federal safety standards. Using a garage door opener without these features increases risk of serious injury or death. For more information, call 1-800-355-3515 or on the internet at www.homelink.com.**

Retain the original transmitter for future programming procedures (i.e., new vehicle purchase). It is also suggested that upon the sale of the vehicle, the programmed Homelink® buttons be erased for security purposes (follow step 1 in the "Programming" portion of this text).

Programming

Your vehicle may require the ignition switch to be turned to the ACC position for programming and/or operation of Homelink®. It is also recommended that a new battery be replaced in the hand-held transmitter of the device being programmed to Homelink® for quicker training and accurate transmission of the radio-frequency.

Follow these steps to train your Homelink® mirror:

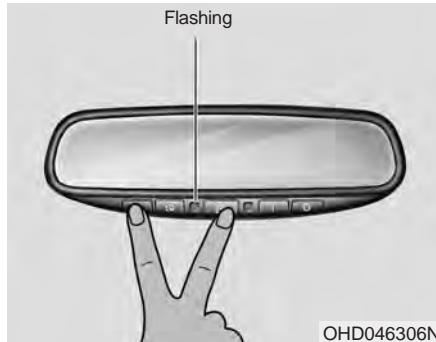

1. When programming the buttons for the first time, press and hold the left and center buttons (🏠, 🏠) simultaneously until the indicator light begins to flash after approximately 20 seconds. (This procedure erases the factory-set default codes. Do not perform this step to program additional hand-held transmitters.)

*** NOTICE**

For non rolling code garage door openers, follow steps 2 - 3.

For rolling code garage door openers, follow steps 2 - 6.

For Canadian Programming, please follow the Canadian Programming section.

For help with determining whether your garage is non-rolling code or rolling code, please refer to the garage door openers owner's manual or contact Homelink® customer service at 1-800-355-3515.

تلفن شبانه روزی: ۰۲۱-۸۸۸۶۲۰۸۵

FarmaSOS.com

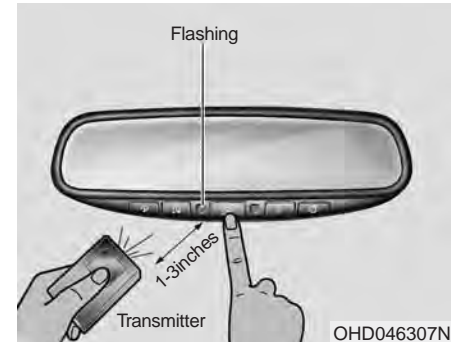

2. Press and hold the button on the Homelink® system you wish to train and the button on the transmitter while the transmitter is approximately 1 to 3 inches away from the mirror. Do not release the buttons until step 3 has been completed.

3. The Homelink® indicator light will flash, first slowly and then rapidly. When the indicator light flashes rapidly, both buttons may be released. (The rapid flashing light indicates successful programming of the new frequency signal.)

* NOTICE

Some gate operators and garage door openers may require you to replace step #3 with the "cycling" procedure noted in the "Canadian Programming" section of this document.

Rolling code programming

To train a garage door opener (or other rolling code equipped devices) with the rolling code feature, follow these instructions after completing the "Programming" portion of this text. (A second person may make the following training procedures quicker & easier.)

4. Locate the "learn" or "smart" button on the device's motor head unit. Exact location and color of the button may vary by product brand. If there is difficulty locating the "learn" or "smart" button, reference the device's owner's manual or contact Homelink® at 1-800-355-3515 or on the internet at www.homelink.com.
5. Press and release the "learn" or "smart" button on the device's motor head unit. You have 30 seconds to complete step number 6.

6. Return to the vehicle and firmly press and release the programmed Homelink® button up to three times. The rolling code equipped device should now recognize the Homelink® signal and activate when the Homelink® button is pressed. The remaining two buttons may now be programmed if this has not previously been done. Refer to the "Programming" portion of this text.

Operating Homelink®

To operate, simply press the programmed Homelink® button. Activation will now occur for the trained product (garage door, security system, entry door lock, estate gate, or home or office lighting). For convenience, the hand-held transmitter of the device may also be used at any time. The Homelink® Wireless Controls System (once programmed) or the original hand-held transmitter may be used to activate the device (e.g. garage door, entry door lock, etc.). In the event that there are still programming difficulties, contact Homelink® at 1-800-355-3515 or on the internet at www.homelink.com.

Erasing programmed Homelink® buttons

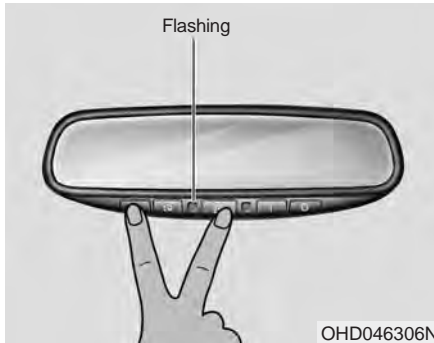

To erase the three programmed buttons (individual buttons cannot be erased):

- Press and hold the left and center buttons simultaneously, until the indicator light begins to flash (approximately 20 seconds). Release both buttons. Do not hold for longer than 30 seconds.

Homelink® is now in the train (or learning) mode and can be programmed at any time.

Reprogramming a single Homelink® button

To program a device to Homelink® using a Homelink® button previously trained, follow these steps:

1. Press and hold the desired Homelink® button. Do NOT release until step 4 has been completed.
2. When the indicator light begins to flash slowly (after 20 seconds), position the hand-held transmitter 1 to 3 inches away from the Homelink® surface.
3. Press and hold the hand-held transmitter button (or press and "cycle" - as described in "Canadian Programming" above).
4. The Homelink® indicator light will flash, first slowly and then rapidly. When the indicator light begins to flash rapidly, release both buttons.

The previous device has now been erased and the new device can be activated by pushing the Homelink® button that has just been programmed. This procedure will not affect any other programmed Homelink® buttons.

Gate operator programming & canadian programming

During programming, your hand-held transmitter may automatically stop transmitting. Continue to press and hold the Homelink® button (note steps 2 through 4 in the "Programming" portion of this text) while you press and re-press ("cycle") your handheld transmitter every two seconds until the frequency signal has been learned. The indicator light will flash slowly and then rapidly after several seconds upon successful training.

Accessories

If you would like additional information on the Homelink® Wireless Control System, Homelink® compatible products, or to purchase other accessories such as the HomeLink® Lighting Package, please contact Homelink® at 1-800-355-3515 or on the internet at www.homelink.com.

This device complies with Industry Canada Standard RSS-210.

Operation is subject to the following two conditions:

1. This device may not cause harmful interference, and
2. This device must accept any interference received, including interference that may cause undesired operation.

WARNING

The HomeLink® transmitter has been tested and complies with FCC and DOC/MDC rules. Changes or modifications not expressly approved by the party responsible for compliance could void the user's authority to operate the equipment.

IC: 4112104541A Gentex

MODEL/FCC ID: NZLSTDHL3

تلفن شبانه روزی: ۰۲۱-۸۸۸۶۲۰۸۵

FarmaSOS.com

Outside rearview mirror

Be sure to adjust mirror angles before driving.

Your vehicle is equipped with both left-hand and right-hand outside rearview mirrors. The mirrors can be adjusted remotely with the remote switch (if equipped). The mirror heads can be folded to prevent damage during an automatic car wash or when passing through a narrow street.

The right outside rearview mirror is convex. Objects seen in the mirror are closer than they appear.

Use your interior rearview mirror or direct observation to determine the actual distance of following vehicles when changing lanes.

⚠ CAUTION - Rearview mirror

Do not scrape ice off the mirror face; this may damage the surface of the glass. If ice should restrict movement of the mirror, do not force the mirror for adjustment. To remove ice, use a deicer spray, or a sponge or soft cloth with very warm water.

⚠ WARNING - Mirror adjustment

Do not adjust or fold the outside rearview mirrors while the vehicle is moving. This could result in loss of control.

Remote control



Electric type

The electric remote control mirror switch allows you to adjust the position of the left and right outside rearview mirrors. To adjust the position of either mirror the ignition switch should be in the ACC or ON position.

Move the lever (1) to R or L to select the right side mirror or the left side mirror, then press a corresponding point on the mirror adjustment control to position the selected mirror up, down, left or right.

After the adjustment, put the lever into neutral (center) position to prevent inadvertent adjustment.

⚠ CAUTION - Outside mirror

- *The mirrors stop moving when they reach the maximum adjusting angles, but the motor continues to operate while the switch is pressed. Do not press the switch longer than necessary, the motor may be damaged.*
- *Do not attempt to adjust the outside rearview mirror by hand. Doing so may damage the parts.*

Folding the outside rearview mirror



Electric type

The outside rearview mirror can be folded or unfolded by pressing the switch as below.

Left (1) : The mirror will unfold.

Right (2) : The mirror will fold.

Center (AUTO, 3) :

The mirror will fold or unfold automatically as follows:

- Without smart key system
 - The mirror will fold or unfold when the door is locked or unlocked by the transmitter.
- With smart key system
 - The mirror will fold or unfold when the door is locked or unlocked by the smart key.
 - The mirror will fold or unfold when the door is locked or unlocked by the button on the outside door handle.
 - The mirror will unfold when you approach the vehicle (all doors closed and locked) with a smart key in possession. (if equipped)



CAUTION - Electric type outside rearview mirror

The electric type outside rearview mirror operates even though the ignition switch is in the OFF position. However, to prevent unnecessary battery discharge, do not adjust the mirrors longer than necessary while the engine is not running. Do not attempt to fold the electric type outside rearview mirror by hand because doing so could cause motor damage or failure.

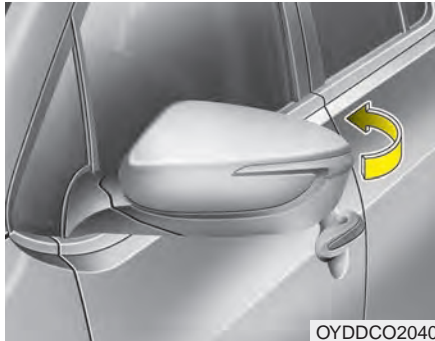

Manual type

To fold outside rearview mirror, grasp the housing of mirror and then fold it toward the rear of the vehicle.

امداد خودرو فارما

تلفن شبانه روزی: ۰۲۱-۸۸۸۶۲۰۸۵

FarmaSOS.com

INSTRUMENT CLUSTER

■ Type A / Type B



1. Tachometer
2. Speedometer
3. Engine coolant temperature gauge
4. Fuel gauge
5. Turn signal indicators
6. Warning and indicator lights
7. LCD display

■ Type C



* The actual cluster in the vehicle may differ from the illustration.
For more details refer to the "Gauges" in the next pages.

OYDNDI3001C/OYDNDI2002C

Instrument Cluster Control

Adjusting Instrument Cluster Illumination

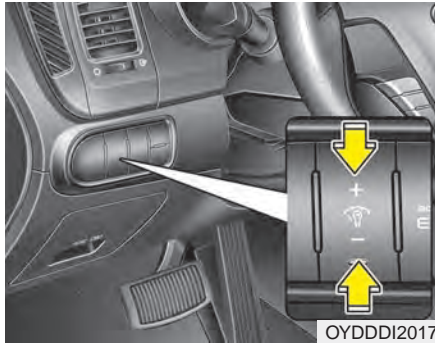

The instrument panel illumination intensity can be adjusted by pressing the control switch with the headlight switch in any position when the ignition switch is in the ON position.

The illumination intensity is shown on the instrument cluster LCD display.

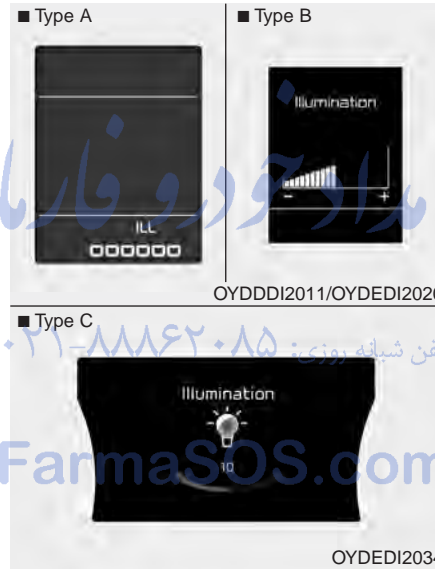

- If the brightness reaches to the maximum or minimum level, an alarm will sound.

- If you hold the illumination control button ("+" or "-"), the brightness will be changed continuously.

LCD Display Control

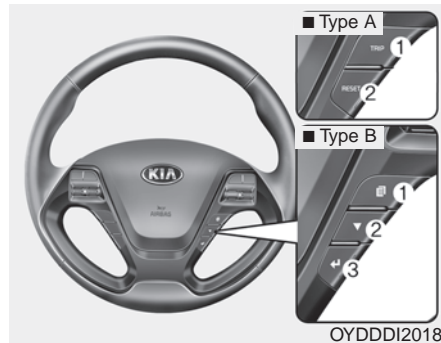



The LCD display modes can be changed by using the control buttons on the steering wheel.

[Type A]

- (1) TRIP : TRIP button for changing trip modes
- (2) RESET : RESET button for resetting items

[Type B]

- (1)  : MODE button for changing modes
- (2)  : MOVE button for changing items
- (3)  : SELECT/RESET button for setting or resetting the selected item

* For the LCD modes, refer to "LCD Display" in this chapter.

تلفن شبانه روزی: ۰۲۱-۸۸۸۶۲۰۸۵

FarmaSOS.com

Gauges

Speedometer



The speedometer indicates the forward speed of the vehicle.

The speedometer is calibrated in kilometers per hour and/or miles per hour.

Tachometer

■ Type A, B



OYDDDI2005

■ Type C



OYDDDI2006

The tachometer indicates the approximate number of engine revolutions per minute (rpm).

Use the tachometer to select the correct shift points and to prevent lugging and/or over-revving the engine.

The tachometer pointer may move slightly when the ignition switch is in ACC or ON position with the engine OFF. This movement is normal and will not affect the accuracy of the tachometer once the engine is running.

⚠ CAUTION - Red zone

Do not operate the engine within the tachometer's RED ZONE. This may cause severe engine damage.

تلفن شبانه روزی: ۰۲۱-۸۸۶۲۰۸۵

FarmaSOS.com

Engine coolant temperature gauge

■ Type A, B



■ Type B

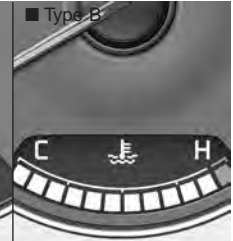

OYDDDI2007/OYDDDI2008

This gauge shows the temperature of the engine coolant when the ignition switch is ON.

Do not continue driving with an overheated engine. If your vehicle overheats, refer to "If the engine overheats" in chapter 6.

If the gauge pointer moves beyond the normal range area toward the "H" position, it indicates overheating that may damage the engine.

Fuel gauge

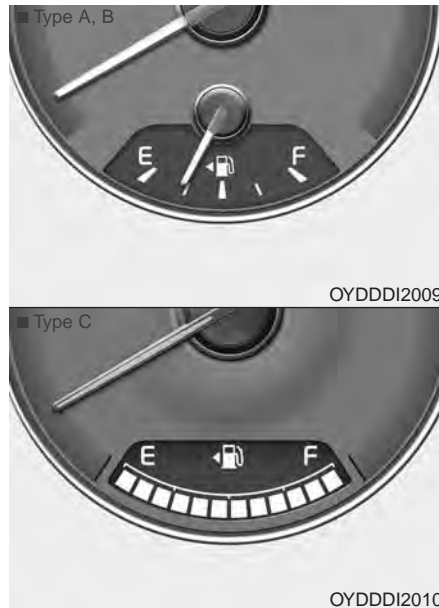

The fuel gauge indicates the approximate amount of fuel remaining in the fuel tank. The fuel tank capacity is given in chapter 8. The fuel gauge is supplemented by a low fuel warning light, which will illuminate when the fuel tank is nearly empty.

On inclines or curves, the fuel gauge pointer may fluctuate or the low fuel warning light may come on earlier than usual due to the movement of fuel in the tank.

⚠ WARNING - Fuel gauge
Stop and obtain additional fuel as soon as possible after the warning light comes on or when the gauge indicator comes close to the E level. Running out of fuel can expose vehicle occupants to danger.

⚠ CAUTION - Low fuel
Avoid driving with extremely low fuel level. Running out of fuel could cause the engine to misfire, damaging the catalytic converter.

Odometer

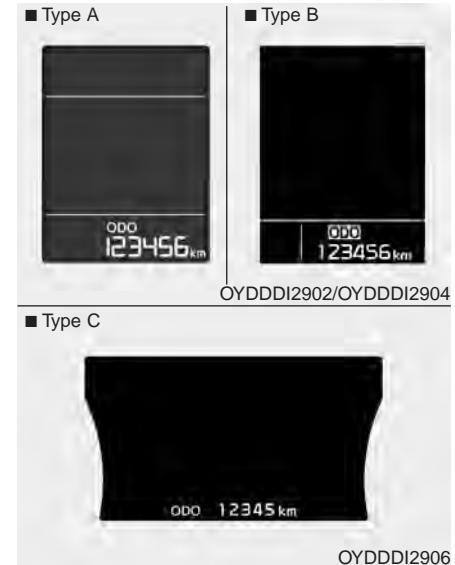

The odometer indicates the total distance the vehicle has been driven.

You will also find the odometer useful to determine when periodic maintenance should be performed.

Transaxle Shift Indicator

Automatic Transaxle Shift Indicator (if equipped)

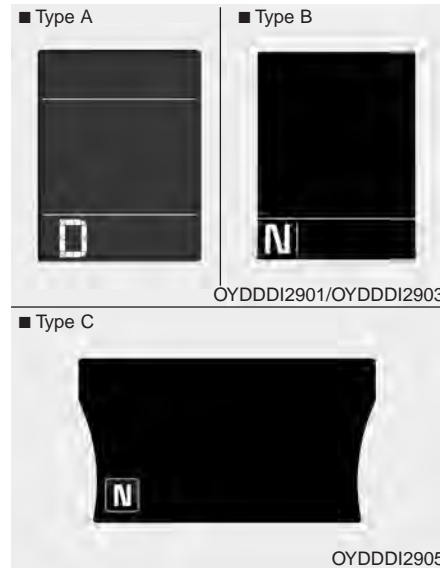

This indicator displays which automatic transaxle shift lever is selected.

- Park : P
- Reverse : R
- Neutral : N
- Drive : D
- Sports Mode : 1, 2, 3, 4, 5, 6

امداد خودرو فارما

تلفن شبانه روزی: ۰۲۱-۸۸۸۶۲۰۸۵

FarmaSOS.com

Manual transaxle shift indicator (if equipped)



This indicator informs you which gear is desired while driving to save fuel.

For example









- ▲⤴: Indicates that shifting up to the 3rd gear is desired (currently the shift lever is in the 2nd gear).
- ▼⤵: Indicates that shifting down to the 3rd gear is desired (currently the shift lever is in the 4th gear).

* NOTICE

When the system is not working properly, up & down arrow indicator and Gear are not displayed.

LCD DISPLAY (IF EQUIPPED)

LCD Modes

Modes	Symbol		Explanation
	Type B	Type C	
Trip Computer			This mode displays driving information like the tripmeter, fuel economy, and so on. For more details, refer to "Trip Computer" in this chapter.
Service			This mode informs of service interval (mileage or days).
User Settings			On this mode, you can change settings of the doors, lamps, and so on.
A/V (if equipped)	-		This mode displays the state of the A/V system.
Turn By Turn (if equipped)	-		On this mode, you can change settings of the doors, lamps, and so on.

* For controlling the LCD modes, refer to "LCD Display Control" in this chapter.

Service Mode

Service Interval

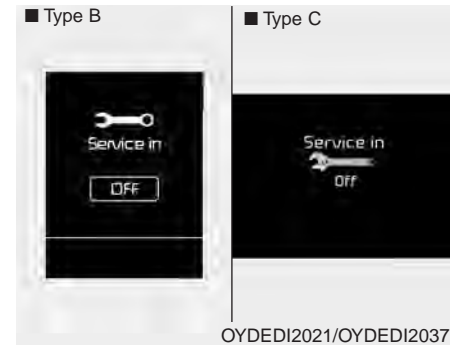
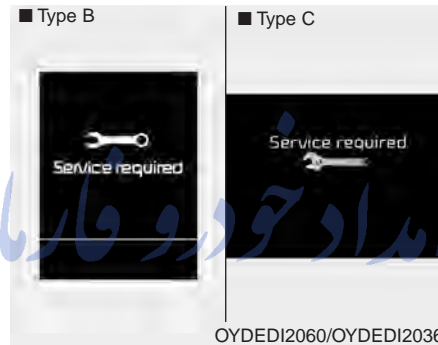
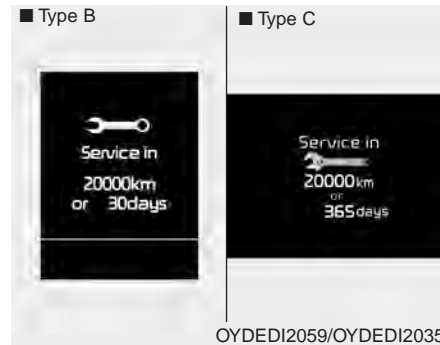

Service in

It calculates and displays when you need a scheduled maintenance service (mileage or days).

If the remaining mileage or time reaches 1,500 km (900 mi.) or 30 days, "Service in" message is displayed for several seconds each time you set the ignition switch or Engine Start/Stop Button to the ON position.

Service required

If you do not have your vehicle serviced according to the already inputted service interval, "Service required" message is displayed for several seconds each time you set the ignition switch or Engine Start/Stop Button to the ON position (The mileage and time changes to "---").

To reset the service interval to the mileage and days you inputted before:

- Press the SELECT/RESET button  for more than 1 second.

Service in OFF

If the service interval is not set, "Service in OFF" message is displayed on the LCD display.

* NOTICE

If any of the following conditions occurs, the mileage and days may be incorrect.

- The battery cable is disconnected.
- The fuse switch is turned off.
- The battery is discharged.

User Settings Mode

Description

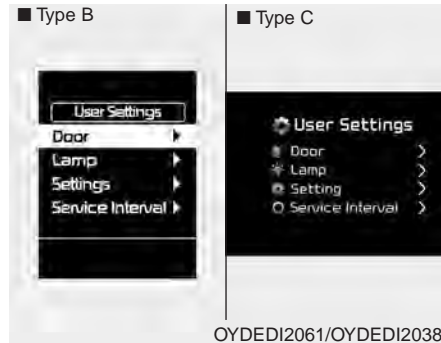

On this mode, you can change setting of the doors, lamps, and so on.

Door

Auto Door Lock (if equipped)

- Off:
The auto door lock operation will be deactivated.
- Speed:
All doors will be automatically locked when the vehicle speed exceeds 15km/h (9.3mph).
- Shift Lever:
All doors will be automatically locked if the automatic transaxle shift lever is shifted from the P (Park) position to the R (Reverse), N (Neutral), or D (Drive) position.

Auto Door Unlock (if equipped)

- Off:
The auto door unlock operation will be canceled.
- Key Out or Power Off:
All doors will be automatically unlocked when the ignition key is removed from ignition switch or Engine Start/Stop Button is set to the OFF position.
- Shift Lever:
All doors will be automatically unlocked if the automatic transaxle shift lever is shifted to the P (Park) position.

FarmaSOS.com

Two Press Unlock (if equipped)

- Off:
The two press unlock function will be deactivated. Therefore, all doors will unlock if the door is unlocked.
- On:
The driver's door will unlock if the door is unlocked. When the door is unlocked again within 4 seconds, all doors will unlock.

Horn Feedback (if equipped)

- Off:
The Horn feedback operation will be deactivated.
- On:
After locking the door by pressing the lock button on the transmitter, if you press the lock button again within 4 seconds, the warning sound will operate once to indicate that all doors are locked.

Lamp

Head Lamp Delay (if equipped)

If this item is checked, the headlamp delay and headlamp welcome function will be activated.

Welcome Light (if equipped)

If this item is checked, the welcome light function of the puddle lamp will be activated.

One Touch Turn Lamp (if equipped)

If this item is checked, the lane change signals will blink 3, 5 or 7 times when the turn signal lever is moved slightly.

Settings

Welcome Sound

If this item is checked, the welcome sound function will be activated.

Shift Indicator (if equipped)

If this item is checked, the shift indicator function will be activated. For more details, refer to "Instrument Cluster" in this chapter.

Seat Easy Access (if equipped)

If this item is checked, the driver's seat will automatically move forward or rearward for the driver to enter or exit the vehicle comfortably.

FarmaSOS.com

AVG Fuel Eco Reset

- Auto Reset:
The average fuel economy will reset automatically when refueling.
- Manual Reset:
The average fuel economy will not reset automatically whenever refueling.

For more details, refer to "Trip Computer" in this chapter.

Service Interval

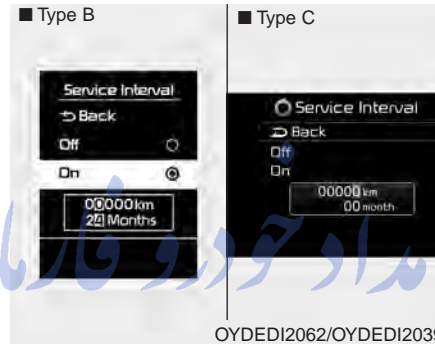

On this mode, you can activate the service interval function with mileage (mi. or km) and period (months).

FarmaSOS.com

A/V Mode (if equipped)

■ Type C



This mode displays the state of the A/V system.

Turn By Turn Mode (if equipped)

■ Type C



This mode displays the state of the navigation.
تلفن شبانه روزی: ۰۸۵+۰۸۶۲

FarmaSOS.com

Warning Messages

Shift to "P" position (for smart key system and automatic transaxle)

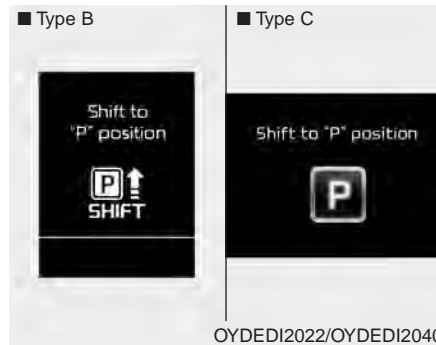

- This warning message illuminates if you try to turn off the engine without the shift lever in P (Park) position.
- At this time, the Engine Start/Stop Button turns to the ACC position (If you press the Engine Start/Stop Button once more, it will turn to the ON position).

Low Key Battery (for smart key system)

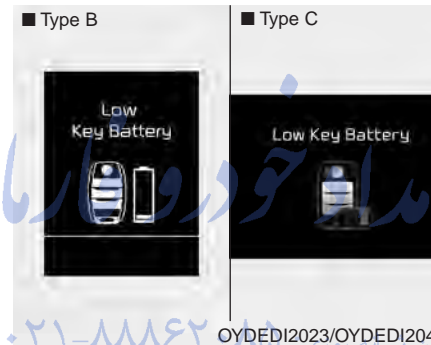

- This warning message illuminates if the battery of the smart key is discharged when the Engine Start/Stop Button changes to the OFF position.

Press start button while turn steering (for smart key system)

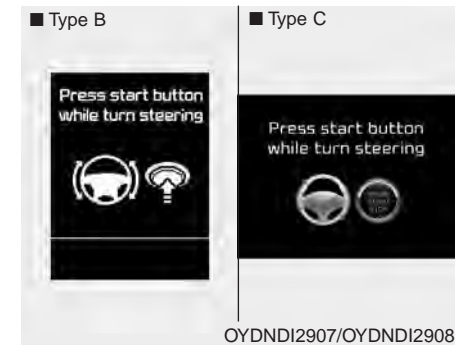

- This warning message illuminates if the steering wheel does not unlock normally when the Engine Start/Stop Button is pressed.
- It means that you should press the Engine Start/Stop Button while turning the steering wheel right and left.

**Steering wheel unlocked
(for smart key system)**



- This warning message illuminates if the steering wheel does not lock when the Engine Start/Stop Button changes to the OFF position.

**Check steering wheel lock
system (for smart key system)**

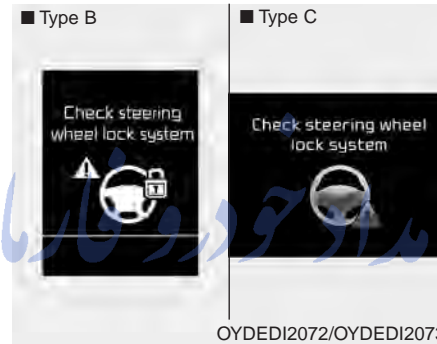

- This warning message illuminates if the steering wheel does not lock normally when the Engine Start/Stop Button changes to the OFF position.

**Press brake pedal to start engine
(for smart key system and auto-
matic transaxle)**

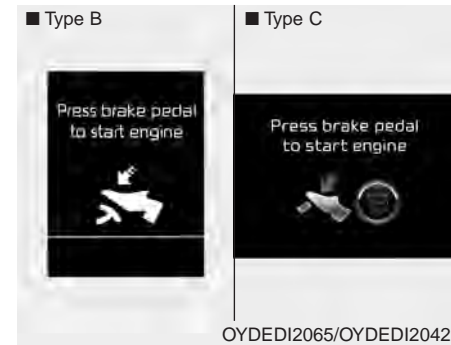

- This warning message illuminates if the Engine Start/Stop Button changes to the ACC position twice by pressing the button repeatedly without depressing the brake pedal.
- It means that you should depress the brake pedal to start the engine.

FarmasOS.com

Press clutch pedal to start engine (for smart key system and manual transaxle)

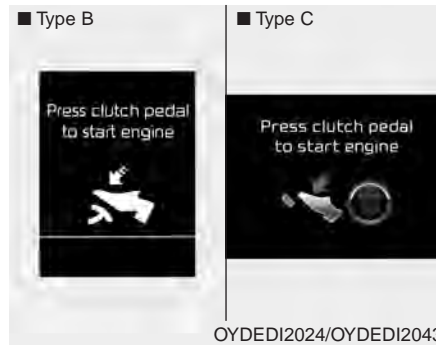

- This warning message illuminates if the Engine Start/Stop Button changes to the ACC position twice by pressing the button repeatedly without depressing the clutch pedal.
- It means that you should depress the clutch pedal to start the engine.

Key not in vehicle (for smart key system)

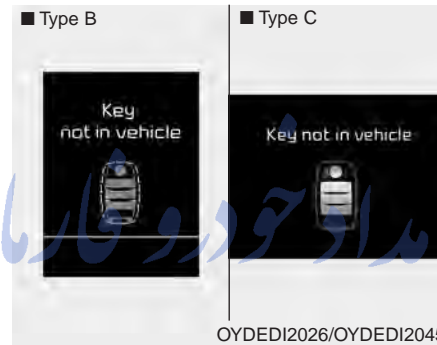

- This warning message illuminates if the smart key is not in the vehicle when you press the Engine Start/Stop Button.
- It means that you should always have the smart key with you.

Key not detected (for smart key system)

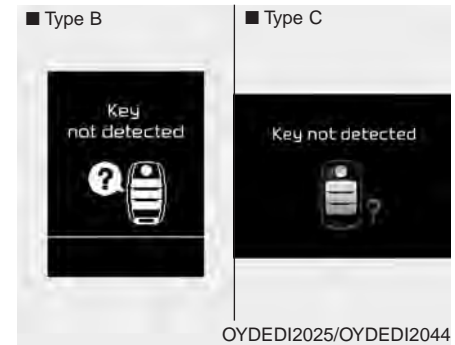

- This warning message illuminates if the smart key is not detected when you press the Engine Start/Stop Button.

**Press start button again
(for smart key system)**

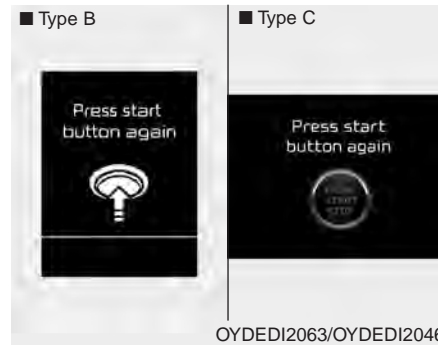

- This warning message illuminates if you can not operate the Engine Start/Stop Button when there is a problem with the Engine Start/Stop Button system.
- It means that you could start the engine by pressing the Engine Start/ Stop Button once more.
- If the warning illuminates each time you press the Engine Start/Stop Button, have your vehicle inspected by an authorized Kia dealer.

**Press start button with smart key
(for smart key system)**



- This warning message illuminates if you press the Engine Start/Stop Button while the warning message "Key not detected" is illuminating.
- At this time, the immobilizer indicator light blinks.

**Check fuse "BRAKE SWITCH"
(for smart key system and automatic transaxle)**

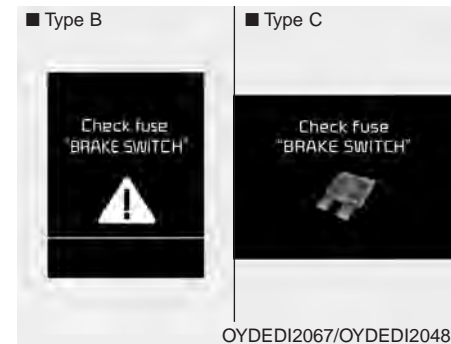

- This warning message illuminates if the brake switch fuse is disconnected.
- It means that you should replace the fuse with a new one. If that is not possible, you can start the engine by pressing the Engine Start/Stop Button for 10 seconds in the ACC position.

Shift to "P" or "N" to start engine (for smart key system and auto- matic transaxle)

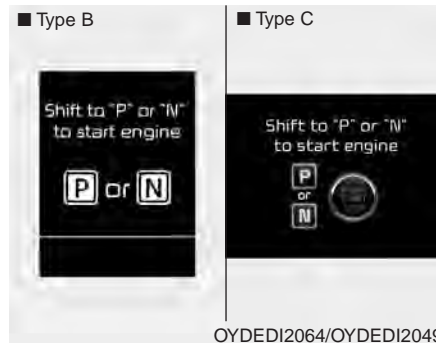

- This warning message illuminates if you try to start the engine with the shift lever not in the P (Park) or N (Neutral) position.

* NOTICE

You can start the engine with the shift lever in the N (Neutral) position. But, for your safety, you should start the engine with the shift lever in the P (Park) position.

امداد خودرو فارما

تلفن شبانه روزی: ۰۲۱-۸۸۸۶۲۰۸۵

FarmaSOS.com

Door Open

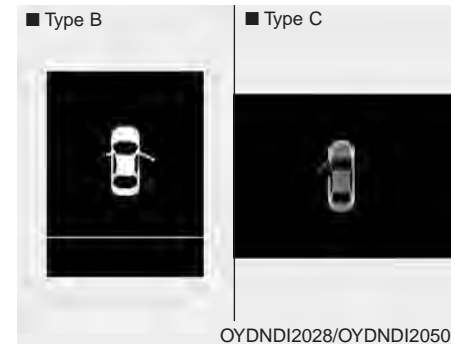

- It means that any door is open.

Trunk Open

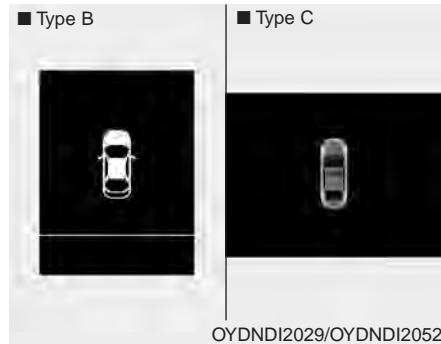

- It means that the trunk is open.

Sunroof Open (if equipped)

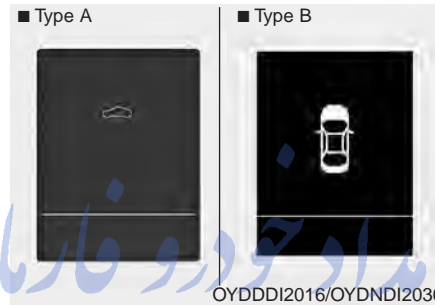

- The warning message illuminates if you turn off the engine and then open the driver's door when the sunroof is open.

Low Washer Fluid (if equipped)

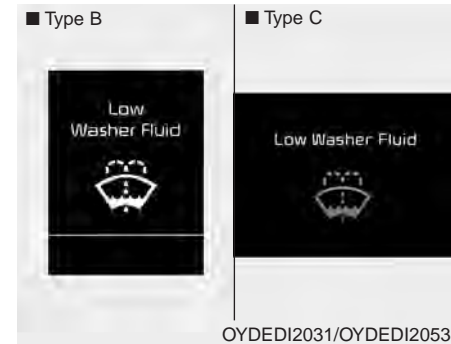

- This warning message illuminates on the service reminder mode if the washer fluid level in the reservoir is nearly empty.
- It means that you should refill the washer fluid.

Turn on "FUSE SWITCH" (if equipped)

■ Type A



■ Type B



OYDDDI2015/OYDEDI2066

■ Type C



OYDEDI2054

- It means that you should turn the fuse switch on.

For more details, refer to "Fuses" in chapter 7.

امداد خودرو فارما

تلفن شبانه روزی: ۰۲۱-۸۸۸۶۲۰۸۵

FarmaSOS.com

- This warning message illuminates if the fuse switch on the fuse box is OFF.

TRIP COMPUTER

Overview

Description

The trip computer is a microcomputer-controlled driver information system that displays information related to driving.

* NOTICE

Some driving information stored in the trip computer (for example Average Vehicle Speed) resets if the battery is disconnected.

Trip Modes

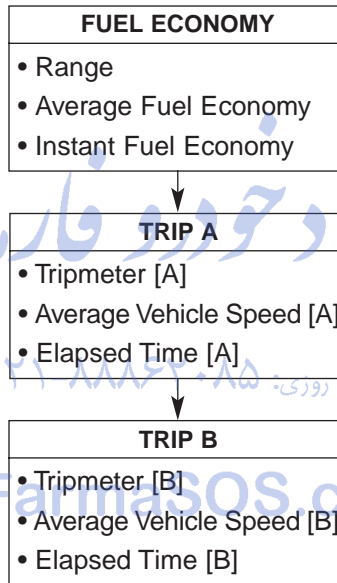

- Type A Cluster
To change the trip mode, press the "TRIP" button.
- Type B, C Cluster
To change the trip mode, press the MOVE button ▼.

Fuel Economy

Range

■ Type A



OYDNDI2012C/OYDNDI2033C

■ Type B



■ Type C



OYDNDI2056C

- The range is the estimated distance the vehicle can be driven with the remaining fuel.

- Distance range : 50 ~ 9999 km or 30 ~ 9999 mi.

- If the estimated distance is below 50 km (30 mi.), the trip computer will display "----" as distance to empty.

* NOTICE

- If the vehicle is not on level ground or the battery power has been interrupted, the distance to empty function may not operate correctly.
- The distance to empty may differ from the actual driving distance as it is an estimate of the available driving distance.
- The trip computer may not register additional fuel if less than 6 liters (1.6 gallons) of fuel are added to the vehicle.
- The fuel economy and distance to empty may vary significantly based on driving conditions, driving habits, and condition of the vehicle.

Average Fuel Economy (2)

- The average fuel economy is calculated by the total driving distance and fuel consumption since the last average fuel economy reset.
 - Fuel economy range: 0.0 ~ 99.9 L/100km or MPG
- The average fuel economy can be reset both manually and automatically.

Manual reset

To clear the average fuel economy manually, press the RESET button (Type A : RESET, Type B, C : ) on the steering wheel for more than 1 second when the average fuel economy is displayed.

Automatic reset

To make the average fuel economy be reset automatically whenever refueling, select the "Auto Reset" mode in User Setting menu of the LCD display (Refer to "LCD Display").

Under "Auto Reset" mode, the average fuel economy will be cleared to zero (---) when the vehicle speed exceeds 1 km/h after refueling more than 6 liters (1.6 gallons).

* NOTICE

The average fuel economy is not displayed for more accurate calculation if the vehicle does not drive more than 10 seconds or 50 meters (0.03 miles) since the ignition switch or Engine Start/Stop button is turned to ON.

Instant Fuel Economy (3)

- This mode displays the instant fuel economy during the last few seconds when the vehicle speed is more than 10 km/h (6.2 MPH).
- Fuel economy range: 0 ~ 30 L/100km or 0 ~ 50 MPG

امداد خودرو فارما

تلفن شبانه روزی: ۰۲۱-۸۸۸۶۲۰۸۵

FarmaSOS.com

Trip A/B

Tripmeter (1)

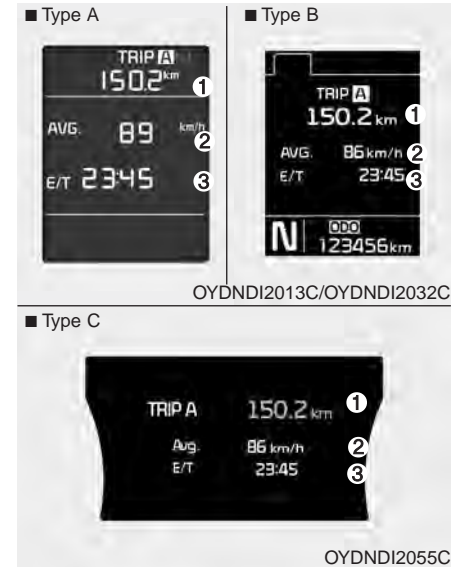

- The tripmeter is the total driving distance since the last tripmeter reset.
- Distance range: 0.0 ~ 9999.9 km or mi.

- To reset the tripmeter, press the RESET button (Type A : RESET, Type B, C : ) on the steering wheel for more than 1 second when the tripmeter is displayed.

Average Vehicle Speed (2)

- The average vehicle speed is calculated by the total driving distance and driving time since the last average vehicle speed reset.
 - Speed range: 0 ~ 999 km/h or MPH
- To reset the average vehicle speed, press the RESET button (Type A : RESET, Type B, C : ) on the steering wheel for more than 1 second when the average vehicle speed is displayed.

*** NOTICE**

- The average vehicle speed is not displayed if the driving distance is less than 50 meters (0.03 miles) or the driving time is less than 10 seconds since the ignition switch or Engine Start/Stop button is turned to ON.
- Even if the vehicle is not in motion, the average vehicle speed keeps going while the engine is running.

Elapsed Time (3)

- The elapsed time is the total driving time since the last elapsed time reset.
 - Time range (hh:mm): 00:00 ~ 99:59
- To reset the elapsed time, press the RESET button (Type A : RESET, Type B, C : ) on the steering wheel for more than 1 second when the elapsed time is displayed.

*** NOTICE**

Even if the vehicle is not in motion, the elapsed time keeps going while the engine is running.

WARNING AND INDICATOR LIGHTS

Warning lights

* NOTICE - Warning lights

Make sure that all warning lights are OFF after starting the engine. If any light is still ON, this indicates a situation that needs attention.

Air bag Warning Light



This warning light illuminates:

- Once you set the ignition switch or Engine Start/Stop Button to the ON position.
 - It illuminates for approximately 6 seconds and then goes off.
- When there is a malfunction with the SRS.

In this case, have your vehicle inspected by an authorized Kia dealer.

تلفن شبانه روزی: ۰۲۱-۸۸۸۶۲۰۸۵

Seat Belt Warning Light



This warning light informs the driver that the seat belt is not fastened. For more details, refer to the "Seat Belts" in chapter 3.

FarmaSOS.com

Parking Brake & Brake Fluid Warning Light



This warning light illuminates:

- Once you set the ignition switch or Engine Start/Stop Button to the ON position.
 - It illuminates for approximately 3 seconds
 - It remains on if the parking brake is applied.
- When the parking brake is applied.
- When the brake fluid level in the reservoir is low.
 - If the warning light illuminates with the parking brake released, it indicates the brake fluid level in reservoir is low.

If the brake fluid level in the reservoir is low:

1. Drive carefully to the nearest safe location and stop your vehicle.
2. With the engine stopped, check the brake fluid level immediately and add fluid as required (For more details, refer to "Brake Fluid" in chapter 7).

Then check all brake components for fluid leaks. If any leak on the brake system is still found, the warning light remains on, or the brakes do not operate properly, do not drive the vehicle.

In this case, have your vehicle towed to an authorized Kia dealer and inspected.

Dual-diagonal braking system

Your vehicle is equipped with dual-diagonal braking systems. This means you still have braking on two wheels even if one of the dual systems should fail.

With only one of the dual systems working, more than normal pedal travel and greater pedal pressure are required to stop the vehicle.

Also, the vehicle will not stop in as short a distance with only a portion of the brake system working.

If the brakes fail while you are driving, shift to a lower gear for additional engine braking and stop the vehicle as soon as it is safe to do so.

FarmaSOS.com

⚠ WARNING - Parking Brake & Brake Fluid Warning Light

Driving the vehicle with a warning light ON is dangerous. If the Parking Brake & Brake Fluid Warning Light illuminates with the parking brake released, it indicates that the brake fluid level is low.

In this case, have your vehicle inspected by an authorized Kia dealer.

Anti-lock Brake System (ABS) Warning Light



This warning light illuminates:

- Once you set the ignition switch or Engine Start/Stop Button to the ON position.
 - It illuminates for approximately 3 seconds and then goes off.
- When there is a malfunction with the ABS (The normal braking system will still be operational without the assistance of the anti-lock brake system).

In this case, have your vehicle inspected by an authorized Kia dealer.

Electronic Brake force Distribution (EBD) System Warning Light



These two warning lights illuminate at the same time while driving:

- When the ABS and regular brake system may not work normally. In this case, have your vehicle inspected by an authorized Kia dealer.

⚠ WARNING - Electronic Brake force Distribution (EBD) System Warning Light

When both ABS and Parking Brake & Brake Fluid Warning Lights are on and stay on, the brake system will not work normally during sudden braking.

In this case, avoid high speed driving and abrupt braking.

Have your vehicle inspected by an authorized Kia dealer as soon as possible.

*** NOTICE - Electronic Brake force Distribution (EBD) System Warning Light**

When the ABS Warning Light is on or both ABS and Parking Brake & Brake Fluid Warning Lights are on, the speedometer, odometer, or trip-meter may not work. Also, the EPS Warning Light may illuminate and the steering effort may increase or decrease.

In this case, have your vehicle inspected by an authorized Kia dealer as soon as possible.

تلفن شبانه روزی: ۰۸۵-۸۸۶۲-۰۲۱

Electronic Power Steering (EPS) Warning Light (if equipped)



This warning light illuminates:

- Once you set the ignition switch or Engine Start/Stop Button to the ON position.
 - It remains on until the engine is started.
- When there is a malfunction with the EPS.

In this case, have your vehicle inspected by an authorized Kia dealer.

FarmaSOS.com

Malfunction Indicator Lamp (MIL)



This warning light illuminates:

- Once you set the ignition switch or Engine Start/Stop Button to the ON position.
 - It remains on until the engine is started.
- When there is a malfunction with the emission control system.

In this case, have your vehicle inspected by an authorized Kia dealer.

⚠ CAUTION - Gasoline Engine

If the Malfunction Indicator Lamp (MIL) illuminates, potential catalytic converter damage is possible which could result in loss of engine power.

In this case, have your vehicle inspected by an authorized Kia dealer as soon as possible.

⚠ CAUTION - Malfunction Indicator Lamp (MIL)

Driving with the Malfunction Indicator Lamp (MIL) on may cause damage to the emission control systems which could effect drivability and/or fuel economy.

Charging System Warning Light



This warning light illuminates:

- Once you set the ignition switch or Engine Start/Stop Button to the ON position.
 - It remains on until the engine is started.
- When there is a malfunction with either the alternator or electrical charging system.

If there is a malfunction with either the alternator or electrical charging system:

1. Drive carefully to the nearest safe location and stop your vehicle.
2. Turn the engine off and check the alternator drive belt for looseness or breakage.

If the belt is adjusted properly, there may be a problem in the electrical charging system.

In this case, have your vehicle inspected by an authorized Kia dealer as soon as possible.

Engine Coolant Temperature Warning Light (if equipped)



This warning light illuminates:

- When the engine coolant temperature is above 120°C (248°F). This means that the engine is overheated and may be damaged.
If your vehicle is overheated, refer to "Overheating" in chapter 6.

⚠ CAUTION - Engine Overheating

Do not drive the vehicle when the Engine Coolant Temperature Warning Light is illuminated or the engine is overheated. Continuing to drive the vehicle while it is overheated may damage the engine.

Engine Oil Pressure Warning Light



This warning light illuminates:

- Once you set the ignition switch or Engine Start/Stop Button to the ON position.
 - It remains on until the engine is started.
- When the engine oil pressure is low.

If the engine oil pressure is low:

1. Drive carefully to the nearest safe location and stop your vehicle.
2. Turn the engine off and check the engine oil level (For more details, refer to "Engine Oil" in section 7). If the level is low, add oil as required.

If the warning light remains on after adding oil or if oil is not available, have your vehicle inspected by an authorized Kia dealer as soon as possible.

⚠ CAUTION - Engine Oil Pressure Warning Light

- *If the engine is not stopped immediately after the Engine Oil Pressure Warning Light is illuminated, severe damage could result.*
- *If the warning light stays on while the engine is running, there may be serious engine damage. In this case,*
 1. *Stop the vehicle as soon as it is safe to do so.*
 2. *Turn off the engine and check the oil level. If the oil level is low, fill the engine oil to the proper level.*
 3. *Start the engine again. If the warning light stays on after the engine is started, turn the engine off immediately. In this case, have your vehicle inspected by an authorized Kia dealer.*

Low Fuel Level Warning Light



This warning light illuminates:
When the fuel tank is nearly empty.

If the fuel tank is nearly empty:
Add fuel as soon as possible.

⚠ CAUTION - Low Fuel Level

Driving with the Low Fuel Level warning light on or with the fuel level below can cause the engine to misfire and damage the catalytic converter (if equipped).

تلفن شبانه روزی: ۰۲۱-۸۸۸۶۲۰۸۵

FarmaSOS.com

Door Ajar Warning Light



This warning light illuminates:
When a door is not closed securely.

Tailgate Open Warning Light



This warning light illuminates:
When the tailgate is not closed securely.

Washer Fluid Warning Light (if equipped)



This warning light illuminates:

- When the washer fluid level in the reservoir is nearly empty.

In this case, you should refill the washer fluid.

امداد خودرو فارما

تلفن شبانه روزی: ۰۸۵-۸۸۸۶۲۰۲۱

FarmaSOS.com

Indicator Lights

Electronic Stability Control (ESC) Indicator Light (if equipped)



This indicator light illuminates:

- Once you set the ignition switch or Engine Start/Stop Button to the ON position.
 - It illuminates for approximately 3 seconds and then goes off.
- When there is a malfunction with the ESC system.

In this case, have your vehicle inspected by an authorized Kia dealer.

This indicator light blinks:

While the ESC is operating.

For more details, refer to "Electronic Stability Control (ESC)" in chapter 5.

Electronic Stability Control (ESC) OFF Indicator Light (if equipped)



This indicator light illuminates:

- Once you set the ignition switch or Engine Start/Stop Button to the ON position.
 - It illuminates for approximately 3 seconds and then goes off.
- When you deactivate the ESC system by pressing the ESC OFF button.

For more details, refer to "Electronic Stability Control (ESC)" in chapter 5.

**ECOMINDER® indicator
Active ECO system**

ECO

This indicator light illuminates:

When the Active ECO button is pressed the ECOMINDER® indicator (green) will illuminate to show that the Active ECO is operating.

For more detailed information, refer to "Active ECO" in chapter 5.

تلفن شبانه روزی: +۲۱-۸۸۸۶۲۰۸۵

FarmaSOS.com

Immobilizer Indicator Light (Without Smart Key)



This indicator light illuminates:

- When the vehicle detects the immobilizer in your key properly while the ignition switch is ON.
 - At this time, you can start the engine.
 - The indicator light goes off after starting the engine.

This indicator light blinks:

- When there is a malfunction with the immobilizer system. In this case, have your vehicle inspected by an authorized Kia dealer.

Immobilizer Indicator Light (With Smart Key)



This indicator light illuminates for up to 30 seconds:

- When the vehicle detects the smart key in the vehicle properly while the Engine Start/Stop Button is ACC or ON.
 - At this time, you can start the engine.
 - The indicator light goes off after starting the engine.

This indicator light blinks for a few seconds:

- When the smart key is not in the vehicle.
 - At this time, you can not start the engine.

This indicator light illuminates for 2 seconds and goes off:

- When the vehicle can not detect the smart key which is in the vehicle while the Engine Start/Stop Button is ON.

In this case, have your vehicle inspected by an authorized Kia dealer.

This indicator light blinks:

- When the battery of the smart key is weak.
 - At this time, you can not start the engine. However, you can start the engine if you press the Engine Start/Stop Button with the smart key. (For more details, refer to "Starting the Engine" in section 5).
- When there is a malfunction with the immobilizer system.

In this case, have your vehicle inspected by an authorized Kia dealer.

Turn Signal Indicator Light

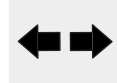

This indicator light blinks:

- When you turn the turn signal light on.

If any of the following occurs, there may be a malfunction with the turn signal system. In this case, have your vehicle inspected by an authorized Kia dealer.

- The indicator light does not blink but illuminates.
- The indicator light blinks more rapidly.
- The indicator light does not illuminate at all.

High Beam Indicator Light



This indicator light illuminates:

- When the headlights are on and in the high beam position
- When the turn signal lever is pulled into the Flash-to-Pass position.

Light ON Indicator Light



This indicator light illuminates:

- When the tail lights or headlights are on.

Front Fog Indicator Light (if equipped)



This indicator light illuminates:

- When the front fog lights are on.

Cruise Indicator Light (if equipped)



This indicator light illuminates:

- When the cruise control system is enabled.

For more details, refer to "Cruise Control System" in chapter 5.

Cruise SET Indicator Light (if equipped)



This indicator light illuminates:

- When the cruise control speed is set.

For more details, refer to "Cruise Control System" in chapter 5.

KEY OUT Indicator Light (if equipped)



When the ENGINE START/STOP button is in the ACC or ON position, if any door is open, the system checks for the smart key.

This indicator light blinks:

When the smart key is not in the vehicle and any door is open with the ignition switch or Engine Start/Stop button in the ACC or ON position.

- At this time, if you close all doors, the chime will also sound for approximately 5 seconds.
- The indicator will go off while the vehicle is moving.

امداد خودرو فارما

تلفن شبانه روزی: ۰۲۱-۸۸۸۶۲۰۸۵

FarmaSOS.com

PARKING ASSIST SYSTEM (IF EQUIPPED)

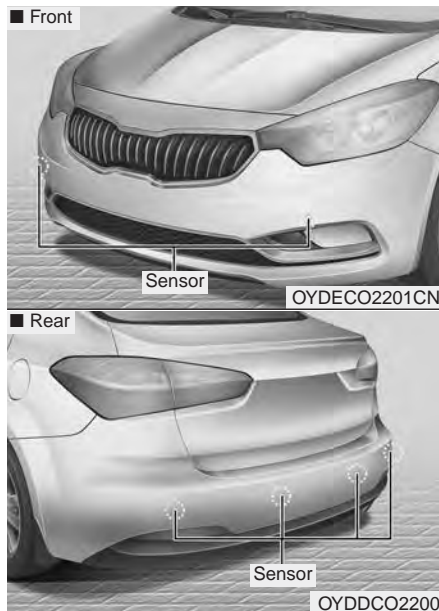

This system is a supplemental system and it is not intended to nor does it replace the need for extreme care and attention of the driver.

The sensing range and objects detectable by the sensors are limited. Whenever moving pay as much attention to what is in front of and behind you as you would in a vehicle without a parking assist system.

⚠ WARNING

The parking assist system should only be considered as a supplementary function. The driver must check the front and rear view. The operational function of the parking assist system can be affected by many factors and conditions of the surroundings, so the responsibility rests always with the driver.

تلفن شبانه روزی: ۰۲۱-۸۸۸۶۲۰۸۵

FarmaSOS.com

The parking assist system assists the driver during movement of the vehicle by chiming if any object is sensed within the distance of 60 cm (23.62 in) in front or 120 cm (47 in) behind the vehicle.

Operation of the parking assist system

Operating condition

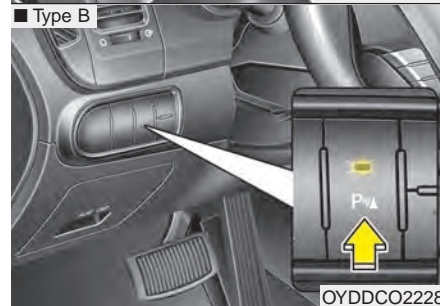
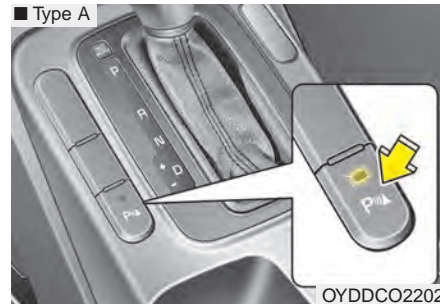

- Sensing distance in backing up is approximately 120 cm (47 in) when you are driving less than 10 km/h (6.21 mph).
- Sensing distance in moving forward is approximately 60 cm (23.62 in) when you are driving less than 10 km/h (6.21 mph).
- When more than two objects are sensed at the same time, the closest one will be recognized first.
- If you move the shift lever to the R position with the engine start/stop button in the ON position and the parking assist system in OFF, the parking assist system will operate automatically. But it will turn off automatically, when the vehicle speed exceeds than 20km/h (12.4 mph)





* NOTICE

The parking assist system may not operate if it's distance from the object is already less than approximately 25 cm (9.84 in) when the system is ON.

- This system will activate when the parking assist button is pressed with the engine running.

Type of warning indicator and sound

 : with Warning sound

Distance from object		Warning indicator		Warning sound
		When driving forward	When driving rearward	
120cm~61cm (47in ~ 24)	Front	-	-	-
	Rear	-		Buzzer beeps intermittently
60cm~31cm (23.6in ~ 12.2)	Front			Buzzer beeps frequently
	Rear	-		Buzzer beeps frequently
30cm (11.8 in)	Front			Buzzer sounds continuously
	Rear	-		Buzzer sounds continuously

*** NOTICE**

- The actual warning sound and indicator may differ from the illustration according to objects or sensor status.
- Do not wash the vehicle's sensor with high pressure water.

⚠ CAUTION

- *This system can only sense objects within the range and location of the sensors;*

It can not detect objects in other areas where sensors are not installed. Also, small or slim objects, such as poles or objects located between sensors may not be detected by the sensors.

Always visually check behind the vehicle when backing up.

- *Be sure to inform any drivers of the vehicle that may be unfamiliar with the system regarding the systems capabilities and limitations.*

Non-operational conditions of parking assist system

Parking assist system may not operate when:

1. Moisture is frozen to the sensor. (It will operate normally when moisture melts.)
2. Sensor is covered with foreign matter, such as snow or water, or the sensor cover is blocked. (It will operate normally when the material is removed or the sensor is no longer blocked.)
3. Sensor is stained with foreign matter such as snow or water. (Sensing range will return to normal when removed.)

There is a possibility that the parking assist system may not operate when:

1. Driving on uneven road surfaces such as unpaved roads, gravel, bumps, or gradient.
2. Objects generating excessive noise such as vehicle horns, loud motorcycle engines, or truck air brakes interfere with the sensor.
3. Heavy rain or water spray.
4. Wireless transmitters or mobile phones are present near the sensor.
5. Sensor is covered with snow.

Detection range may decrease when:

1. Outside air temperature is extremely hot or cold.
2. There are undetectable objects smaller than 1 m (39.37 in) and narrower than 14 cm (5.51 in) in diameter.

The following objects may not be recognized by the sensor:

1. Sharp or slim objects such as ropes, chains or small poles.
2. Objects, which tend to absorb sensor frequency such as clothes, spongy material or snow.

FarmaSOS.com

* NOTICE

1. The warning may not sound sequentially depending on the speed and shapes of the objects detected.
2. The parking assist system may malfunction if the vehicle bumper height or sensor installation has been modified. Any non-factory installed equipment or accessories may also interfere with the sensor performance.
3. Sensor may not recognize objects less than 30 cm (11.81 in) from the sensor, or it may sense an incorrect distance. Use with caution.
4. When the sensor is frozen or stained with snow or water, the sensor may be inoperative until the stains are removed using a soft cloth.
5. Do not push, scratch or strike the sensor with any hard objects that could damage the surface of the sensor. Sensor damage could occur.

* NOTICE

This system can only sense objects within the range and location of the sensors, it can not detect objects in other areas where sensors are not installed. Also, small or slim objects, or objects located between sensors may not be detected.

Always visually check in front and behind the vehicle when driving.

Be sure to inform any drivers in the vehicle that may be unfamiliar with the system regarding the system's capabilities and limitations.

تلفن شبانه روزی: ۰۲۱-۸۸۸۶۲۰۸۵

FarmaSOS.com

WARNING

Pay close attention when the vehicle is driven close to objects on the road, particularly pedestrians, and especially children. Be aware that some objects may not be detected by the sensors, due to the objects distance, size or material, all of which can limit the effectiveness of the sensor. Always perform a visual inspection to make sure the vehicle is clear of all obstructions before moving the vehicle in any direction.

Self-diagnosis

When you shift the gear to the R (Reverse) position and if one or more of the below occurs you may have a malfunction in the rear parking assist system.

- You don't hear an audible warning sound or if the buzzer sounds intermittently.



is displayed. (if equipped)

have your vehicle checked by an authorized Kia dealer as soon as possible.

امداد خودرو فارما

تلفن شبانه روزی: ۰۲۱-۸۸۸۶۲۰۸۵

FarmaSOS.com

REARVIEW CAMERA (IF EQUIPPED)



The rear view camera will activate with the ignition switch on and the shift lever in the R (Reverse) position.

Note- during initial start up, system may not display instantly due to the audio system booting up.

2 ~ 4 seconds may be required before displaying during initial reverse selection. This occurs when starting and immediately shifting to reverse.

This system is a supplemental system that shows behind the vehicle through the UVO audio or navigation display backing-up.

Always keep the camera lens clean. If lens is covered with foreign matter, the camera may not operate normally.

تلفن شبانه روزی: ۰۲۱-۸۸۸۶۲۰۸۵

FarmaSOS.com

⚠ WARNING - Rearview camera

The rearview camera is not a substitute for proper and safe backing-up procedures. Always drive safely and use caution when backing up. The rearview camera may not display every object behind the vehicle.

⚠ WARNING - Backing & using camera

Never rely solely on the rear view camera when backing.

LIGHTING

Battery saver function

- The purpose of this feature is to prevent the battery from being discharged. The system automatically turns off the parking lights when the driver removes the ignition key and opens the driver-side door.
- With this feature, the parking lights will turn off automatically if the driver parks on the side of the road at night.

If necessary, to keep the lights on when the ignition key is removed, perform the following:

- 1) Open the driver-side door.
- 2) Turn the parking lights OFF and ON again using the light switch on the steering column.

Headlight escort function (if equipped)

The headlights (and/or taillights) will remain on for approximately 20 minutes after the ignition key is removed or turned to the ACC or LOCK position. However, if the driver's door is opened and closed, the headlights are turned off after 30 seconds.

The headlights can be turned off by pressing the lock button on the transmitter (or smart key) twice or turning off the light switch from the headlight or Auto light position.

تلفن شبانه روزی: ۰۲۱-۸۸۸۶۲۰۸۵

FarmaSOS.com

CAUTION

If the driver gets out of the vehicle through other doors (except driver's door), the battery saver function does not operate and the headlight escort function does not turn off automatically. Therefore, it causes the battery to be discharged. In this case, make sure to turn off the lamp before getting out of the vehicle.

WARNING

If the headlights are not working properly have your vehicle inspected by an authorized Kia dealer.

Don't attempt to inspect or replace the wiring yourself to prevent malfunction.

Daytime running light

Daytime Running Lights (DRL) can make it easier for others to see the front of your vehicle during the day. DRL can be helpful in many different driving conditions, and it is especially helpful after dawn and before sunset.

The DRL system turns OFF when:

1. The position lights or headlights are ON.
2. The parking brake is applied.
3. Engine stops.

Lighting control



The light switch has a Headlight and a Parking light position.

To operate the lights, turn the knob at the end of the control lever to one of the following positions:

- (1) OFF position
- (2) Parking light position
- (3) Headlight position
- (4) Auto light position (if equipped)

Parking light position (پارکینگ)



When the light switch is in the parking light position (1st position), the tail, position, license and instrument panel lights will turn ON.

Headlight position (☞)



When the light switch is in the headlight position (2nd position) the head, tail, position, license and instrument panel lights will turn ON.

The ignition switch must be in the ON position to turn on the headlights.

Auto light position (if equipped)

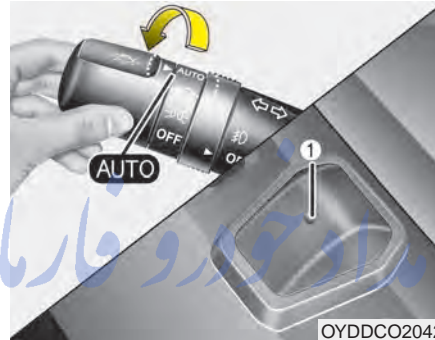

When the light switch is in the AUTO light position, the taillights and headlights will turn ON or OFF automatically depending on the amount of light outside the vehicle.

Never place anything over the sensor (1) located on the instrument panel. This will ensure better auto-light system control.

Do not clean the sensor using a window cleaner, the cleaner may leave a light film which could interfere with sensor operation.

If your vehicle has window tint or other types of metallic coating on the front windshield, the Auto light system may not work properly.

High beam operation



To turn on the high beam headlights, push the lever away from you. Pull it back for low beams.

The high-beam indicator will light when the headlight high beams are switched on.

To prevent the battery from being discharged, do not leave the lights on for a prolonged time while the engine is not running.

⚠ WARNING - High beams
Do not use high beam when there are other vehicles. Using high beam could obstruct the other driver's vision.

امداد خودرو فارما

تلفن شبانه روزی: ۰۲۱-۸۸۸۶۲۰۸۵

FarmaSOS.com



To flash the headlights, pull the lever towards you. It will return to the normal (low-beam) position when released. The headlight switch does not need to be on to use this flashing feature.

Turn signals and lane change signals

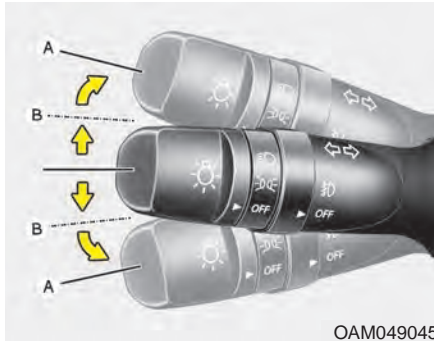

OAM049045

The ignition switch must be on for the turn signals to function. To turn on the turn signals, move the lever up or down (A). The green arrow indicators on the instrument panel indicate which turn signal is operating. They will self-cancel after a turn is completed. If the indicator continues to flash after a turn, manually return the lever to the OFF position.

To signal a lane change, move the turn signal lever slightly and hold it in position (B). The lever will return to the OFF position when released.

If an indicator stays on and does not flash or if it flashes abnormally, one of the turn signal bulbs may be burned out and will require replacement.

If an indicator flash is abnormally quick or slow, a bulb may be burned out or have a poor electrical connection in the circuit.

امداد خودرو فارما

تلفن شبانه روزی: ۰۲۱-۸۸۸۶۲۰۸۵

FarmaSOS.com

One-touch lane change function

To activate an one-touch lane change function, move the turn signal lever slightly and then release it. The lane change signals will blink 3, 5 or 7 times.

You can choose one-touch lane change blinking function in "One touch turn lamp" of "User setting". Refer to "User setting" in chapter 4.

* NOTICE

If an indicator flash is abnormally quick or slow, the bulb may be burned out or have a poor electrical connection in the circuit.

Front fog light (if equipped)



Fog lights are used to provide improved visibility when visibility is poor due to fog, rain or snow, etc. The fog lights will turn on when the fog light switch (1) is turned to the on position after the headlights are turned on.

To turn off the fog lights, turn the switch (1) to the off position.

When in operation, the fog lights consume large amounts of vehicle electrical power. Only use the fog lights when visibility is poor.

امداد خودرو فارما

تلفن شبانه روزی: ۰۲۱-۸۸۸۶۲۰۸۵

FarmaSOS.com

WIPERS AND WASHERS

Front

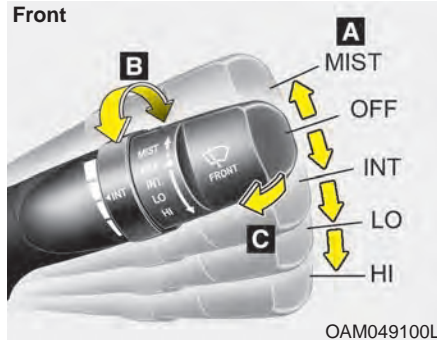

A : Wiper speed control (front)

- HI – High wiper speed
- LO – Low wiper speed
- INT – Intermittent wipe
- AUTO* – Automatic control wipe
- OFF – Off
- MIST – Single wipe

B : Intermittent control wipe time adjustment

C : Wash with brief wipes (front)

* : if equipped

Windshield wipers

Operates as follows when the ignition switch is turned ON.

MIST : For a single wiping cycle, push the lever upward and release it. The wipers will operate continuously if the lever is held in this position.

OFF : Wiper is not in operation

INT : Wiper operates intermittently at the same wiping intervals. Use this mode in a light rain or mist. To vary the speed setting, turn the speed control knob.

LO : Normal wiper speed

HI : Fast wiper speed

If there is a heavy accumulation of snow or ice on the windshield, defrost the windshield for about 10 minutes, or until the snow and/or ice is removed before using the windshield wipers to ensure proper operation.

Windshield washers



In the OFF position, pull the lever gently toward you to spray washer fluid on the windshield and to run the wipers 1-3 cycles.

Use this function when the windshield is dirty.

The spray and wiper operation will continue until you release the lever. If the washer does not work, check the washer fluid level.

If the fluid level is not sufficient, you add appropriate non-abrasive windshield washer fluid to the washer reservoir.

INTERIOR LIGHT

Do not use the interior lights for extended periods when the engine is not running.

It may cause battery discharge.

⚠ WARNING - Interior light
Do not use the interior lights when driving in the dark. The glare from the interior lights may obstruct your view and cause an accident.

Automatic turn off function (if equipped)

The interior lights automatically turn off approximately 20 minutes after the ignition switch is turned off.

If your vehicle is equipped with the theft alarm system, the interior lights automatically turn off approximately 3 seconds after the system is in armed stage.

تلفن شبانه روزی: ۰۸۵-۸۸۸۶۲۰۲۱

FarmaSOS.com

Map lamp (if equipped)

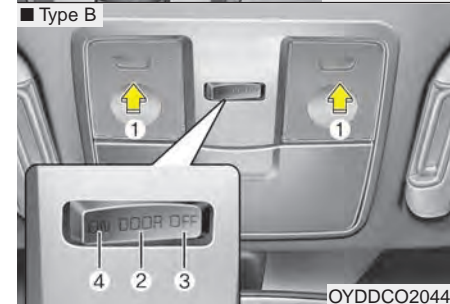

Push the lens (1) to turn the map lamp on or off. This light produces a spot beam for convenient use as a map lamp at night or as a personal lamp for the driver and front passenger.

- DOOR (2) :

In the DOOR position, the map lamp and the room lamp come on when any door is opened regardless of the ignition switch position. When doors are unlocked by the transmitter (or smart key), the map lamp and the room lamp come on for approximately 30 seconds as long as any door is not open.

The map lamp and the room lamp go out gradually after approximately 30 seconds if the door is closed. However, if the ignition switch is ON or all doors are locked, the map lamp and the room lamp will turn off immediately. If a door is opened with the ignition switch in the ACC or LOCK position, the map lamp and the room lamp stays on for about 20 minutes. However, if a door is opened with the ignition switch in the ON position, the map lamp and the room lamp stays on continuously. If the type B room lamp switch is OFF, it doesn't work.

- OFF (3) : The lights turn off even if a door is opened.

When the lamp is turned ON by pressing the lens (1), the lamp does not turn off even if the switch (2) is in the OFF position.

- ON (4) : The map lamp and the room lamp stay on at all times.

Room lamp



To turn the room lamp ON or OFF, push the switch.

If your vehicle is not equipped with a map lamp, the room lamp will also turn on or off as follows.

- The room lamp comes on when a door is opened. The lamps go out after approximately 30 seconds.
- The room lamp comes on for approximately 30 seconds when doors are unlocked with a transmitter or smart key as long as the doors are not opened.

- The room lamp will stay on for approximately 20 minutes if a door is opened with the ignition switch in the ACC or LOCK/OFF position.
- The room lamp will stay on continuously if the door is opened with the ignition switch in the ON position.
- The room lamp will go out immediately if the ignition switch is changed to the ON position or all doors are locked.

Trunk room lamp

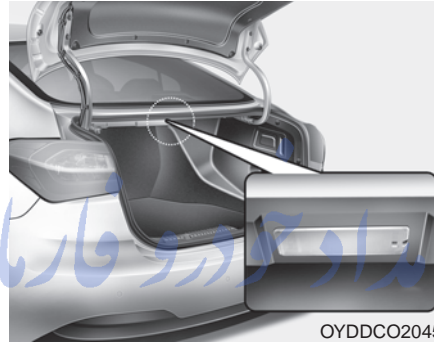

The trunk room lamp comes on when the trunk is opened.

⚠ CAUTION

The trunk room lamp comes on as long as the trunk lid opens. To prevent unnecessary charging system drain, close the trunk lid securely after using the trunk.

Glove box lamp

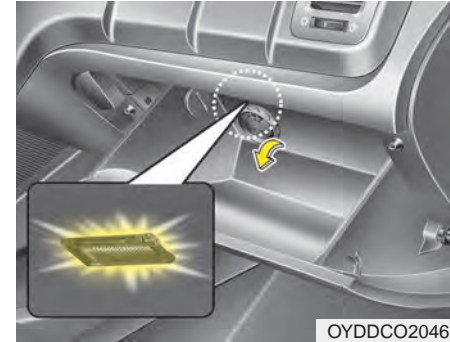

The glove box lamp comes on when the glove box is opened.

The parking lights or headlights must be ON for the glove box lamp to function.



⚠ CAUTION

To prevent unnecessary charging system drain, close the glove box securely after use.

Vanity mirror lamp (if equipped)



Push the switch to turn the light on or off.

-  : The lamp will turn on if this button is pressed.
-  : The lamp will turn off if this button is pressed.

Always have the switch in the off position when the vanity mirror lamp is not in use. If the sunvisor is closed without turning the lamp off, it may discharge the battery or damage the sunvisor.

امداد خودرو فارما

تلفن شبانه روزی: ۰۲۱-۸۸۸۶۲۰۸۵

FarmaSOS.com

WELCOME SYSTEM (IF EQUIPPED)

Headlamp welcome

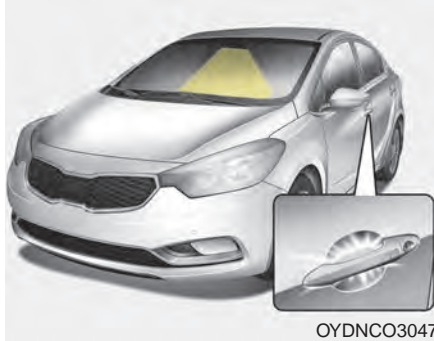

When the headlight(light switch in the headlight or AUTO position) is on and all doors (and trunk) are locked and closed, the headlight, position light and tail light will come on for 15 seconds if any of the below is performed.

- Without smart key system
 - When the door unlock button is pressed on the transmitter.
- With the smart key system
 - When the door unlock button is pressed on the smart key.

At this time, if you press the door lock button (on the transmitter or smart key), the lights will turn off immediately.

Interior light welcome

When the interior light switch is in the DOOR position and all doors (and trunk) are locked and closed, the room lamp will come on for 30 seconds if any of the below is performed.

- Without smart key system
 - When the door unlock button is pressed on the transmitter.
- With the smart key system
 - When the door unlock button is pressed on the smart key.
 - When the button of the outside door handle is pressed.

At this time, if you press the door lock button, the lamps will turn off immediately.

Puddle lamp and pocket lamp (if equipped)

When all doors are locked and closed, the puddle lamp and pocket lamp will come on for 15 seconds if any of the below is performed.

- With the smart key system
 - When the door unlock button is pressed on the smart key.
 - When the button of the outside door handle is pressed.
 - When the vehicle is approached with the smart key in possession.

At this time, if you press the door lock button, the lamps will turn off immediately.

DEFROSTER

⚠ CAUTION - Conductors

To prevent damage to the conductors bonded to the inside surface of the rear window, never use sharp instruments or window cleaners containing abrasives to clean the window.

If you want to defrost and defog the front windshield, refer to "Windshield Defrosting and Defogging" in this section.

Rear window defroster

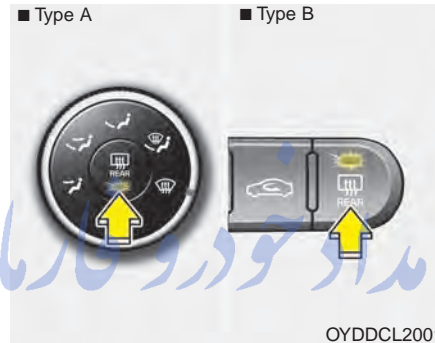

The defroster heats the window to remove frost, fog and thin ice from the interior and exterior of the rear window, while the engine is running.

To activate the rear window defroster, press the rear window defroster button located in the center facia switch panel. The indicator on the rear window defroster button illuminates when the defroster is on.

If there is heavy accumulation of snow on the rear window, brush it off before operating the rear defroster.

The rear window defroster automatically turns off after approximately 20 minutes or when the ignition switch is turned off. To turn off the defroster manually, press the rear window defroster button again.

Outside mirror defroster (if equipped)

If your vehicle is equipped with the outside rearview mirror defrosters, they will operate at the same time you turn on the rear window defroster.

Front wiper deicer (if equipped)

If your vehicle is equipped with the front wiper deicer, it will be operating at the same time you operate the front windshield defroster.

MANUAL CLIMATE CONTROL SYSTEM





تلفن شبانه روزی: ۰۲۱-۸۸۸۶۲۰۸۵

FarmaSOS.com

- | | |
|-----------------------------|---------------------------------|
| 1. Fan speed control knob | 4. Air conditioning button |
| 2. Mode selection knob | 5. Air intake control button |
| 3. Temperature control knob | 6. Rear window defroster button |

Heating and air conditioning

1. Start the engine.
2. Set the mode to the desired position.
To improve the effectiveness of heating and cooling :
 - Heating: 
 - Cooling: 
3. Set the temperature control to the desired position.
4. Set the air intake control to the outside (fresh) air or recirculated air position.
5. Set the fan speed control to the desired speed.
6. If air conditioning is desired, turn the air conditioning system (if equipped) on.

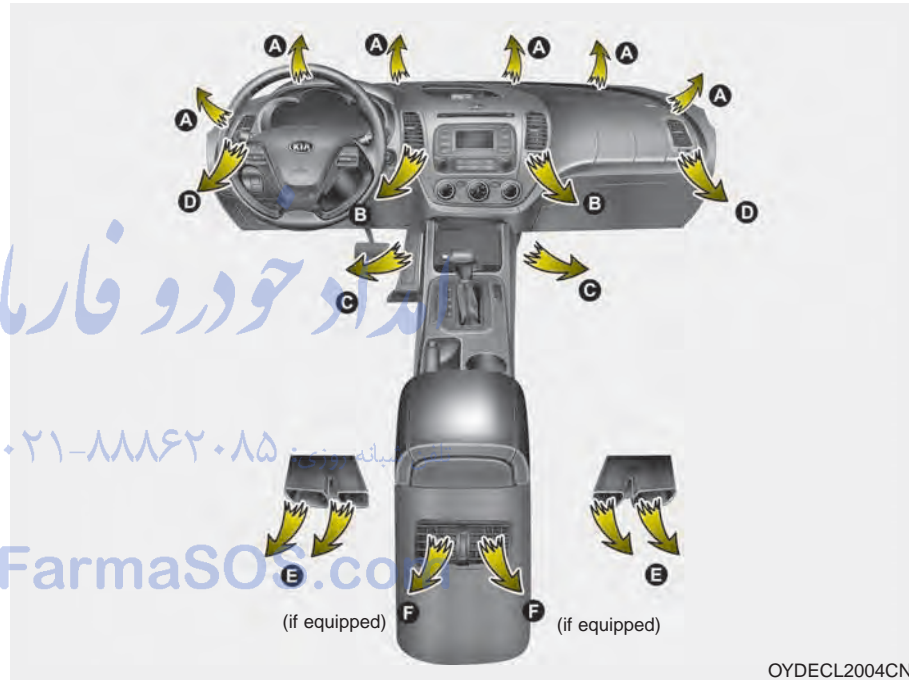

Mode selection



OYDDCL2003

The mode selection knob controls the direction of the air flow through the ventilation system.

Air can be directed to the floor, dashboard outlets, or windshield. Six symbols are used to represent Face, Bi-Level, Floor, Floor-Defrost and Defrost air position.



Face-Level (B, C, D, E, F)

Air flow is directed toward the upper body and face. Additionally, each outlet can be controlled to direct the air discharged from the outlet.



Floor/Defrost-Level (A, C, D, E)

Most of the air flow is directed to the floor and the windshield with a small amount directed to the side window defrosters.



Bi-Level (B, C, D, E, F)

Air flow is directed towards the face and the floor.



Defrost-Level (A, D)

Most of the air flow is directed to the windshield with a small amount of air directed to the side window defrosters.



Floor-Level (A, C, D, E)

Most of the air flow is directed to the floor, with a small amount of the air being directed to the windshield and side window defrosters.

اراد خودروفا
 ۰۲۱-۸۸۶۲۰۸۵ تلفن شبانه روزی
 FarmaSOS.com

MAX A/C-Level (B, D) (if equipped)



OYDDCL2005

The MAX A/C mode is used to cool the inside of the vehicle faster. Air flow is directed toward the upper body and face.

In this mode, the air conditioning and the recirculated air position will be selected automatically.



Instrument panel vents

The outlet vents can be opened or closed separately using the thumbwheel.

Also, you can adjust the direction of air delivered from these vents using the vent control lever as shown.

Temperature control



OYDDCL2007

The temperature control knob allows you to control the temperature of the air flowing from the ventilation system. To change the air temperature in the passenger compartment, turn the knob to the right for warm air or left for cooler air.

Air intake control



This is used to select outside (fresh) air position or recirculated air position. To change the air intake control position, push the control button.

Recirculated air position



The indicator light on the button illuminates when the recirculated air position is selected.

With the recirculated air position selected, air from the passenger compartment will be drawn through the heating system and heated or cooled according to the function selected.

Prolonged operation of the heater in the recirculated air position (without air conditioning selected) may cause fogging of the windshield and side windows and the air within the passenger compartment may become stale.

In addition, prolonged operation of the air conditioning with the recirculated air position selected will result in excessively dry air in the passenger compartment.

Outside (fresh) air position



The indicator light on the button will not illuminate when the outside (fresh) air position is selected.

With the outside (fresh) air position selected, air enters the vehicle from outside and is heated or cooled according to the function selected.

⚠ WARNING

- Continuous use of the climate control system in the recirculated air position may allow humidity to increase inside the vehicle which may fog the glass and obscure visibility.
- Do not sleep in a vehicle with the air conditioning or heating system on. It may cause serious harm or death due to a drop in the oxygen level and/or body temperature.
- Continue using the climate control system in the recirculated air position can cause drowsiness or sleepiness, and loss of vehicle control. Set the air intake control to the outside (fresh) air position as much as possible while driving.

Fan speed control



The ignition switch must be in the ON position for fan operation. The fan speed control knob allows you to control the fan speed of the air flowing from the ventilation system. To change the fan speed, turn the knob to the right for higher speed or left for lower speed.

Setting the fan speed control knob to the "0" position turns off the fan.

To turn off the blowers



To turn off the blowers, turn the fan speed control knob to the "0" position.



Air conditioning (if equipped)

Press the A/C button to turn the air conditioning system on (indicator light will illuminate). Press the button again to turn the air conditioning system off.

System operation**Ventilation**

1. Set the mode to the  position.
2. Set the air intake control to the outside (fresh) air position.
3. Set the temperature control to the desired position.
4. Set the fan speed control to the desired speed.

Heating

1. Set the mode to the  position.
 2. Set the air intake control to the outside (fresh) air position.
 3. Set the temperature control to the desired position.
 4. Set the fan speed control to the desired speed.
 5. If dehumidified heating is desired, turn the air conditioning system (if equipped) on.
- If the windshield fogs up, set the mode to the  ,  position.

Operation Tips

- To prevent dust or unpleasant fumes from entering the vehicle through the ventilation system, temporarily set the air intake control to the recirculated air position. Be sure to return the control to the fresh air position when the irritation has passed to keep fresh air in the vehicle. This will help keep the driver alert and comfortable.
- Air for the heating/cooling system is drawn in through the grilles just ahead of the windshield. Care should be taken that these are not blocked by leaves, snow, ice or other obstructions.
- To prevent interior fog on the windshield, set the air intake control to the fresh air position and fan speed to the desired position, turn on the air conditioning system, and adjust the temperature control to desired temperature.

Air conditioning (if equipped)

Kia Air Conditioning Systems are filled with R-134a refrigerant.

1. Start the engine. Push the air conditioning button.
 2. Set the mode to the  position.
 3. Set the air intake control to the recirculated air position. However, prolonged operation in the recirculated air position will excessively dry the air. In this case, change the air position.
 4. Adjust the fan speed control and temperature control to maintain maximum comfort.
- When maximum cooling is desired, set the temperature control to the extreme left position, set the mode control to the MAX A/C position, then set the fan speed control to the highest speed.

 **CAUTION - Excessive AC**
While using the air conditioning system, monitor the temperature gauge closely while driving up hills or in heavy traffic when outside temperatures are high. Air conditioning system operation may cause engine overheating and potential engine damage. Continue to use the blower fan but turn the air conditioning system off if the temperature gauge indicates engine overheating.

تلفن شبانه روزی: +۸۵-۸۸۸۶۲-۰۲۱

FarmaSOS.com

Air conditioning system operation tips

- If the vehicle has been parked in direct sunlight during hot weather, open the windows for a short time to let the hot air inside the vehicle escape.
- To help reduce moisture inside of the windows on rainy or humid days, decrease the humidity inside the vehicle by operating the air conditioning system.
- During air conditioning system operation, you may occasionally notice a slight change in engine speed as the air conditioning compressor cycles. This is a normal system operation characteristic.
- Use the air conditioning system every month only for a few minutes to ensure maximum system performance.
- When using the air conditioning system, you may notice clear water dripping (or even puddling) on the ground under the passenger side of the vehicle. This is a normal system operation characteristic.

- Operating the air conditioning system in the recirculated air position provides maximum cooling, however, continual operation in this mode may cause the air inside the vehicle to become stale.
- During cooling operation, you may occasionally notice a misty air flow because of rapid cooling and humid air intake. This is a normal system operation characteristic.

Climate control air filter

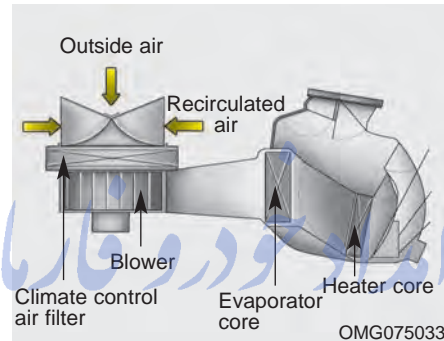

The climate control air filter installed behind the glove box filters the dust or other pollutants that come into the vehicle from the outside through the heating and air conditioning system. If dust or other pollutants accumulate in the filter over a period of time, the air flow from the air vents may decrease, resulting in moisture accumulation on the inside of the windshield even when the outside (fresh) air position is selected. If this happens, have the climate control air filter replaced by an authorized Kia dealer.

* NOTICE

- **Replace the filter according to the Maintenance Schedule.**
If the vehicle is being driven in severe conditions such as dusty, rough roads, more frequent climate control air filter inspections and changes are required.
- **When the air flow rate suddenly decreases, the system should be checked at an authorized Kia dealer.**

Checking the amount of air conditioner refrigerant and compressor lubricant

When the amount of refrigerant is low, the performance of the air conditioning is reduced. Overfilling also has a negative influence on the air conditioning system.

Therefore, if abnormal operation is found, have the system inspected by an authorized Kia dealer.

 **CAUTION - Compressor damage**

It is important that the correct type and amount of oil and refrigerant is used. Otherwise, damage to the compressor and abnormal system operation may occur.

 **WARNING**



Because the refrigerant is at very high pressure, the air conditioning system should only be serviced by trained and certified technicians. It is important that the correct type and amount of oil and refrigerant is used, otherwise damage to the vehicle and personal injury may occur.

The air conditioning system should be serviced by an authorized Kia dealer.

FarmaSOS.com

AUTOMATIC CLIMATE CONTROL SYSTEM (IF EQUIPPED)



- | | |
|--------------------------------------|---|
| 1. Driver's temperature control knob | 7. Air intake control button |
| 2. AUTO (automatic control) button | 8. Rear window defroster button |
| 3. OFF button | 9. Passenger's temperature control knob |
| 4. Front windshield defroster button | 10. Dual temperature control selection button |
| 5. Mode selection button | 11. Air conditioning button |
| 6. Fan speed control switch | 12. Climate control display |

OYDECL2011CN

Automatic heating and air conditioning



1. Push the AUTO button. The modes, fan speeds, air intake and air-conditioning will be controlled automatically by temperature setting.



2. Turn the temperature control knob to set the desired temperature.

تلفن شبانه روزی: ۰۸۵-۸۸۸۶۲۰۲۱

FarmaSOS.com

* NOTICE

- To turn the automatic operation off, select any button or switch of the following:
 - Mode selection button
 - Air conditioning button
 - Front windshield defroster button
 - Air intake control button
 - Fan speed control knobThe selected function will be controlled manually while other functions operate automatically.
- For your convenience and to improve the effectiveness of the climate control, use the AUTO button and set the temperature to 23°C (73°F).

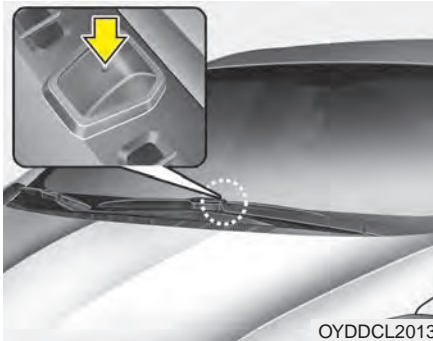

OYDDCL2013

*** NOTICE**

Never place anything over the sensor located on the instrument panel to ensure better control of the heating and cooling system.

Manual heating and air conditioning

The heating and cooling system can be controlled manually by pushing buttons other than the AUTO button. In this case, the system works sequentially according to the order of buttons selected.

1. Start the engine.
2. Set the mode to the desired position.
To improve the effectiveness of heating and cooling :
 - Heating:
 - Cooling:
3. Set the temperature control to the desired position.
4. Set the air intake control to the outside (fresh) air or recirculated air position.
5. Set the fan speed control to the desired speed.
6. If air conditioning is desired, turn the air conditioning system on.
Press the AUTO button in order to convert to full automatic control of the system.

Mode selection



OYDDCL2014

The mode selection button controls the direction of the air flow through the ventilation system.

Every time you press the mode selection button, the mode will change as follows:



Refer to the illustration in the "Manual climate control system".

Features of your vehicle



Face-Level (B, C, D, E, F)

Air flow is directed toward the upper body and face. Additionally, each outlet can be controlled to direct the air discharged from the outlet.



Bi-Level (B, C, D, E, F)

Air flow is discharged towards the face and floor.



Floor-Level (C, A, D, E)

Most of the air flow is directed to the floor, with a small amount of the air being directed to the windshield and side window defroster.



Floor/Defrost-Level (A, C, D, E)

Most of the air flow is directed to the floor and the windshield with a small amount directed to the side window defrosters.



Defrost-level

Most of the air flow is directed to the windshield with a small amount of air directed to the side window defrosters.



Instrument panel vents

The outlet vents can be opened or closed separately using the thumbwheel.

Also, you can adjust the direction of air delivered from these vents using the vent control lever as shown.

Temperature control

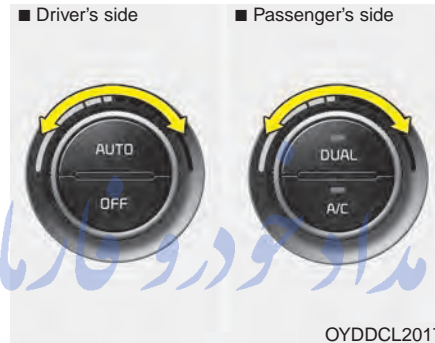

The temperature control knob allows you to control the temperature of the air flowing from the ventilation system. To change the air temperature in the passenger compartment, turn the knob to the right for warm air or left for cooler air.



Adjusting the driver and passenger side temperature individually

1. Press the DUAL button to operate the driver and passenger side temperature individually. Pressing the right temperature control button will automatically switch to the DUAL mode as well.
2. Operate the left temperature control to adjust the driver side temperature. Operate the right temperature control to adjust the passenger side temperature.

When the driver side temperature is set to the highest (HIGH) or lowest (LOW) temperature setting, the DUAL mode is deactivated for maximum heating or cooling.

Adjusting the driver and passenger side temperature equally

1. Press the DUAL button again to deactivate DUAL mode. The passenger side temperature will be set to the same temperature as the driver side temperature.
2. Operate the driver side temperature control switch. The driver and passenger side temperature will be adjusted equally.

تلفن شبانه روزی: ۰۸۵-۸۸۸۶۲۰۲۱

FarmaSOS.com

Air intake control

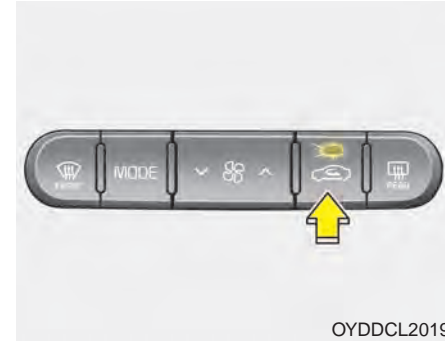

The air intake control is used to select outside (fresh) air position or recirculated air position.

To change the air intake control position, push the control button.

Recirculated air position

With the recirculated air position selected, air from the passenger compartment will be drawn through the heating system and heated or cooled according to the function selected.

Outside (fresh) air position

With the outside (fresh) air position selected, air enters the vehicle from outside and is heated or cooled according to the function selected.

Prolonged operation of the heater in the recirculated air position (without air conditioning selected) may cause fogging of the windshield and side windows and the air within the passenger compartment may become stale.

In addition, prolonged operation of the air conditioning with the recirculated air position selected will result in excessively dry air in the passenger compartment.

تلفن شبانه روزی: ۰۲۱-۸۸۸۶۲۰۸۵

FarmaSOS.com

⚠ WARNING

- **Continuous use of the climate control system in the recirculated air position may allow humidity to increase inside the vehicle which may fog the glass and obscure visibility.**
- **Do not sleep in a vehicle with the air conditioning or heating system on. It may cause serious harm or death due to a drop in the oxygen level and/or body temperature.**
- **Continue using the climate control system in the recirculated air position can cause drowsiness or sleepiness, and loss of vehicle control. Set the air intake control to the outside (fresh) air position as much as possible while driving.**

Fan speed control

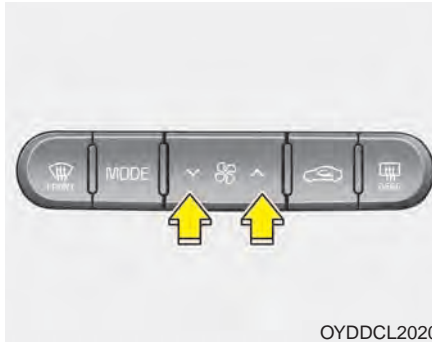

The fan speed can be set to the desired speed by pressing the fan speed control switch.

To change the fan speed press the ^ part of the switch for higher speed or press the v part of the switch for lower speed.

To turn the fan speed control off, press the OFF button.

Air conditioning



Press the A/C button to turn the air conditioning system on (indicator light will illuminate).

Press the button again to turn the air conditioning system off.

OFF mode





Press the OFF button to turn off the air climate control system. However you can still operate the mode and air intake buttons as long as the ignition switch is in the ON position.

System operation

Ventilation

1. Set the mode to the  position.
2. Set the air intake control to the outside (fresh) air position.
3. Set the temperature control to the desired position.
4. Set the fan speed control to the desired speed.

Heating

1. Set the mode to the  position.
 2. Set the air intake control to the outside (fresh) air position.
 3. Set the temperature control to the desired position.
 4. Set the fan speed control to the desired speed.
 5. If dehumidified heating is desired, turn the air conditioning system (if equipped) on.
- If the windshield fogs up, set the mode to the  or  position.

Operation Tips

- To keep dust or unpleasant fumes from entering the vehicle through the ventilation system, temporarily set the air intake control to the recirculated air position. Be sure to return the control to the fresh air position when the irritation has passed to keep fresh air in the vehicle. This will help keep the driver alert and comfortable.
- Air for the heating/cooling system is drawn in through the grilles just ahead of the windshield. Care should be taken that these are not blocked by leaves, snow, ice or other obstructions.
- To prevent interior fog on the windshield, set the air intake control to the fresh air position and fan speed to the desired position, turn on the air conditioning system, and adjust the temperature control to desired temperature.

Air conditioning

Kia Air Conditioning Systems are filled with R-134a refrigerant.

1. Start the engine. Press the air conditioning button.
 2. Set the mode to the  position.
 3. Set the air intake control to the outside air or recirculated air position.
 4. Adjust the fan speed control and temperature control to maintain maximum comfort.
- When maximum cooling is desired, set the temperature control to the extreme left position, then set the fan speed control to the highest speed.

* NOTICE

- When using the air conditioning system, monitor the temperature gauge closely while driving up hills or in heavy traffic when outside temperatures are high. Air conditioning system operation may cause engine overheating. Continue to use the blower fan but turn the air conditioning system off if the temperature gauge indicates engine overheating.
- When opening the windows in humid weather air conditioning may create water droplets inside the vehicle. Since excessive water droplets may cause damage to electrical equipment, air conditioning should only be used with the windows closed.

Air conditioning system operation tips

- If the vehicle has been parked in direct sunlight during hot weather, open the windows for a short time to let the hot air inside the vehicle escape.
- To help reduce moisture inside of the windows on rainy or humid days, decrease the humidity inside the vehicle by operating the air conditioning system.
- During air conditioning system operation, you may occasionally notice a slight change in engine speed as the air conditioning compressor cycles. This is a normal system operation characteristic.
- Use the air conditioning system every month only for a few minutes to ensure maximum system performance.
- When using the air conditioning system, you may notice clear water dripping (or even puddling) on the ground under the passenger side of the vehicle. This is a normal system operation characteristic.
- Operating the air conditioning system in the recirculated air position provides maximum cooling, however, continual operation in this mode may cause the air inside the vehicle to become stale.
- During cooling operation, you may occasionally notice a misty air flow because of rapid cooling and humid air intake. This is a normal system operation characteristic.
- If you operate air conditioner excessively, the difference between the temperature of the outside air and that of the windshield could cause the outer surface of the windshield to fog up, causing loss of visibility. In this case, set the mode selection knob or button to the  position and fan speed control to the lower speed.

WINDSHIELD DEFROSTING AND DEFOGGING

⚠ WARNING - Windshield heating

Do not use the  or  position during cooling operation in extremely humid weather to reduce the likelihood of fog up.



- For maximum defrosting, set the temperature control to the extreme right/hot position and the fan speed control to the highest speed.
- If warm air to the floor is desired while defrosting or defogging, set the mode to the floor-defrost position.
- Before driving, clear all snow and ice from the windshield, rear window, outside rear view mirrors, and all side windows.
- Clear all snow and ice from the hood and air inlet in the cowl grill to improve heater and defroster efficiency and to reduce the probability of fogging up the inside of the windshield.

FarmaSOS.com

Manual climate control system

To defog inside windshield



1. Select any fan speed except "0" position.
2. Select desired temperature.
3. Select the  or  position.
4. The outside (fresh) air will be selected automatically.

If the outside (fresh) air position is not selected automatically, press the corresponding button manually.

To defrost outside windshield



1. Set the fan speed to the highest (extreme right) position.
2. Set the temperature to the extreme hot position.
3. Select the position.
4. The outside (fresh) air will be selected automatically.

Automatic climate control system

To defog inside windshield



1. Select desired fan speed.
2. Select desired temperature.
3. Press the defroster button ().
4. The outside (fresh) air position will be selected automatically.

If the outside (fresh) air position is not selected automatically, adjust the corresponding button manually.

If the position is selected, lower fan speed is adjusted to a higher fan speed.

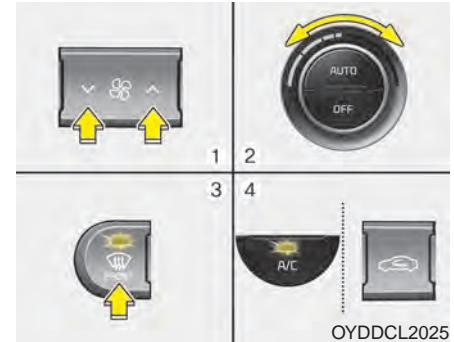

To defrost outside windshield



1. Set the fan speed to the highest position.
2. Set the temperature to the extreme hot (HI) position.
3. Press the defroster button ().
4. The outside (fresh) air position will be selected automatically.

If the position is selected, lower fan speed is adjusted to a higher fan speed.

Defogging Logic

To reduce the probability of fogging up inside of the windshield, the air intake or air conditioning are controlled automatically according to certain conditions such as  or  position. Logic can be disabled and enabled by doing following :

Manual climate control system

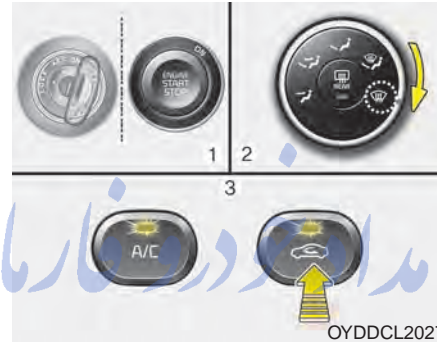



1. Turn the ignition switch to the ON position.
2. Turn the mode selection knob to the defrost position () .
3. Push the air intake control button at least 5 times within 3 seconds. The indicator light in the air intake control button will blink 3 times with 0.5 second of interval. It indicates that the defogging logic is canceled or returned to the programmed status.

If the battery has been discharged or disconnected, it resets to the defog logic status.

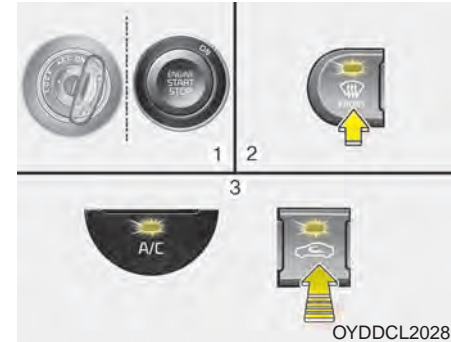
Automatic climate control system



1. Turn the ignition switch to the ON position.
2. Select the defroster position before pressing the defroster button () .
3. While pressing the air conditioning button (A/C), press the air intake control button () at least 5 times within 3 seconds.

The indicator on the air intake button blinks 3 times with 0.5 seconds of interval. It indicates that the defogging logic is canceled or returned to the programmed status.

If the battery has been discharged or disconnected, it resets to the defog logic status.

Auto defogging system (Only for automatic climate control system, if equipped)

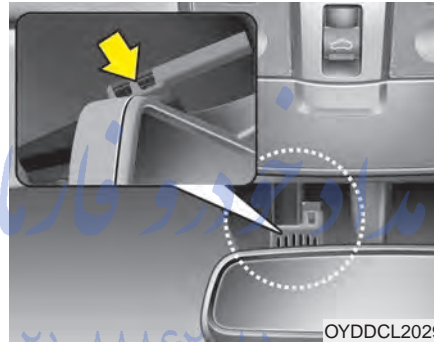

Auto defogging reduces the probability of fogging up the inside of the windshield by automatically sensing the moisture inside the windshield.

The auto defogging system operates when the heater or air conditioning is on.



This indicator illuminates when the auto defogging system senses the moisture inside the windshield and operates.

If more moisture is in the vehicle, higher steps operate as follows. For example, if auto defogging does not defog inside the windshield at step 1 Outside air position, it tries to defog again at step 2 Blowing air toward the windshield.

Step 1 : Outside air position

Step 2 : Blowing air toward the windshield

Step 3 : Increasing air flow toward the windshield

Step 4 : Operating the air conditioning

Step 5 : Maximizing the air conditioning

If your vehicle is equipped with the auto defogging system, it is automatically activated when the conditions are met. However, if you would like to cancel the auto defogging system, press the front defroster button 4 times within 2 seconds while pressing the AUTO button. The indicator will blink 3 times to notify you that the system is cancelled. To use the auto defogging system again, follow the procedures mentioned above.

If the battery has been disconnected or discharged, it resets to the auto defogging status.

* NOTICE

- When the air conditioning is turned on by Auto defogging system, if you try to turn off the air conditioning, the indicator will blink 3 times and the air conditioning will not be turned off.
- For efficiency, do not select recirculated air position while Auto defogging system is operating.

⚠ CAUTION

Do not remove the sensor cover located on the upper end of the driver side windshield glass. Damage to the system parts could occur and may not be covered by your vehicle warranty.

FarmaSOS.com

STORAGE COMPARTMENT

These compartments can be used to store small items.

To avoid possible theft, do not leave valuables in the storage compartment.

Always keep the storage compartment covers closed while driving.

⚠ WARNING - Flammable materials

Do not store flammable/explosive materials in the vehicle. These items may catch fire and/or explode if the vehicle is exposed to hot temperatures for extended periods.

Center console storage (if equipped)

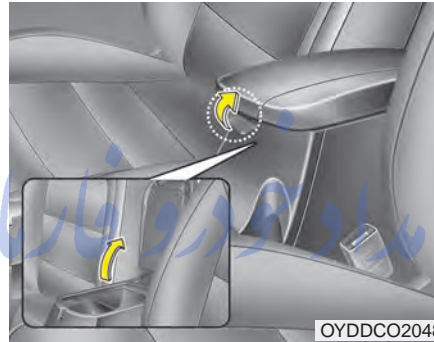

To open the center console storage, pull up the lever.

Glove box

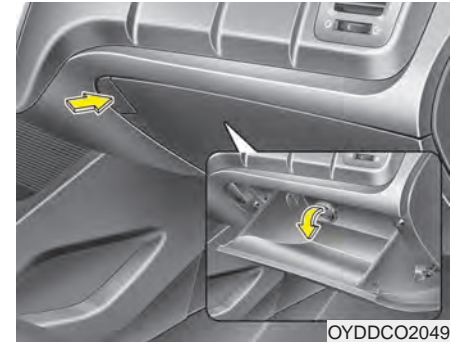

To open the glove box, push the button (1) and the glove box will automatically open. Close the glove box after use.

Cool box (if equipped)

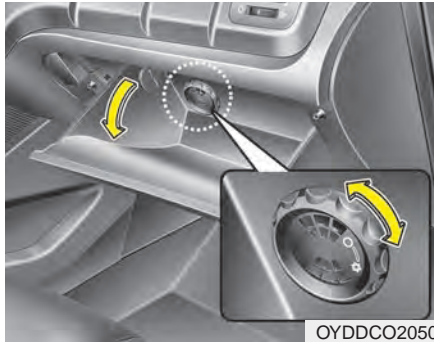

You can keep beverage cans or other items cool in the glove box.

1. Turn on the air conditioning.
2. Slide the open/close lever of the vent installed in the glove box to the open position.
3. When the cool box is not used, slide the lever to the closed position.

If some items in the cool box block the vent, the cooling effectiveness of the coolbox is reduced.

* NOTICE

Do not put perishable food in the cool box because it may not maintain the necessary consistent temperature to keep the food fresh.

* NOTICE

If the temperature control knob is in the warm or hot position, warm or hot air will flow into the glove box.

تلفن شبانه روزی: ۰۲۱-۸۸۸۶۲۰۸۵

FarmaSOS.com

Sunglass holder

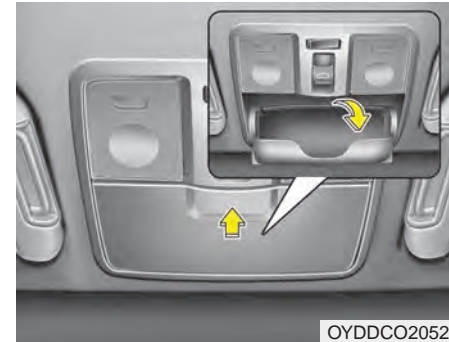

To open the sunglasses holder, press the cover and the holder will slowly open. Place your sunglasses with the lenses facing out.

To close the sunglasses holder, push it up.

Do not place other items in the sunglasses holder.

**⚠ WARNING - Avoid
distracted
driving**

- Do not keep objects except sunglasses inside the sunglass holder. Such objects can be thrown from the holder in the event of a sudden stop or an accident, possibly injuring the passengers in the vehicle.
- Do not open the sunglass holder while the vehicle is moving. The rear view mirror of the vehicle can be blocked by an open sunglass holder.
- Do not put the glasses forcibly into a sunglass holder to prevent breakage or deformation of glasses. It may cause personal injury if you try to open it forcibly when the glasses are jammed in holder.

امداد خودرو فارما

تلفن شبانه روزی: ۰۲۱-۸۸۸۶۲۰۸۵

FarmaSOS.com

INTERIOR FEATURES

Cigarette lighter (if equipped)

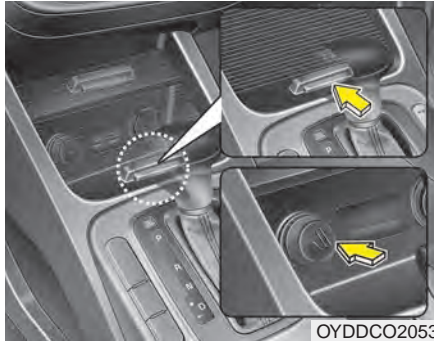

For the cigarette lighter to work, the ignition switch must be in the ACC or ON position.

To use the cigarette lighter, push it all the way into its socket. When the element is heated, the lighter will pop out to the "ready" position.

If it is necessary to replace the cigarette lighter, use only a genuine Kia replacement or its approved equivalent.

- Do not hold the lighter in after it is already heated because it will overheat.
- If the lighter does not pop out within 30 seconds, remove it to prevent overheating.

⚠ CAUTION - Cigarette lighter

Do not insert accessories into the cigarette lighter socket. Doing so can damage the lighter socket

تلفن شبانه روزی: ۰۲۱-۸۸۸۶۲۰۸۵

FarmaSOS.com

Ashtray (if equipped)

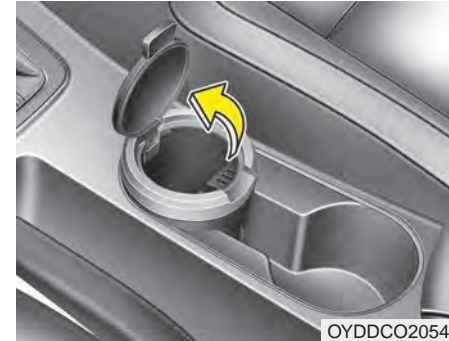

To use the ashtray, open the cover.

To clean or empty the ashtray, pull it out.

⚠ WARNING - Ashtray use
Putting lit cigarettes or matches in an ashtray with other combustible materials may cause a fire.

Cup holder

⚠ WARNING - Hot liquids

- Do not place uncovered cups of hot liquid in the cup holder while the vehicle is in motion. If the hot liquid spills, you may burn yourself. Such a burn to the driver could lead to loss of control of the vehicle.
- To reduce the risk of personal injury in the event of a sudden stop or collision, do not place uncovered or unsecured bottles, glasses, cans, etc., in the cup holder while the vehicle is in motion.

⚠ WARNING

Keep cans or bottles out of direct sun light and do not put them in a vehicle that is heated up. It may explode.

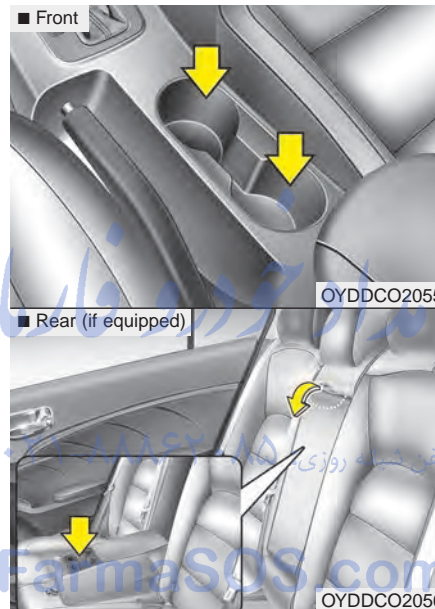

Cups or small beverage cans may be placed in the cup holders.

Sliding armrest (if equipped)

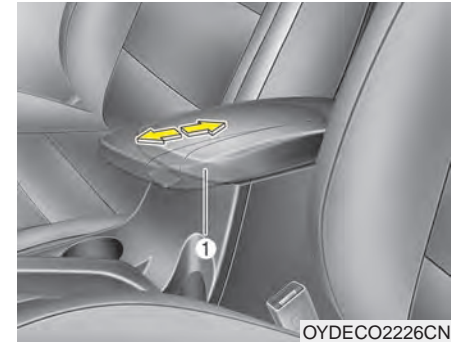

To move forward

Grab the front portion of the armrest (1) then pull it forward

To move rearward

Push the armrest rearward with your palm.

Sunvisor

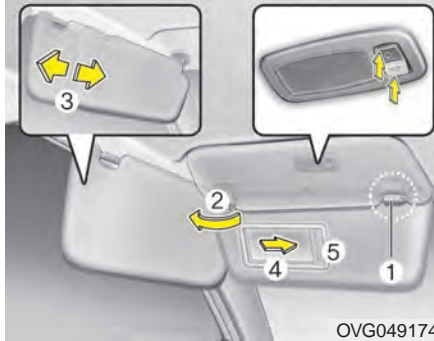

OVG049174

Use the sunvisor to shield direct light through the front or side windows.

To use the sunvisor, pull it downward.

To use the sunvisor for the side window, pull it downward, unsnap it from the bracket (1) and swing it to the side (2).

Adjust the sunvisor extension forward or backward (3).

To use the vanity mirror, pull down the visor and slide the mirror cover (4).

The ticket holder (5) is provided for holding a tollgate ticket (if equipped).

⚠ CAUTION - Vanity mirror lamp

Close the vanity mirror cover securely and return the sunvisor to its original position after use. If the vanity mirror is not closed securely, the lamp will stay on and could result in battery discharge and possible sunvisor damage.

تلفن شبانه روزی: ۰۲۱-۸۸۸۶۲۰۸۵

FarmaSOS.com

Seat warmer (if equipped)

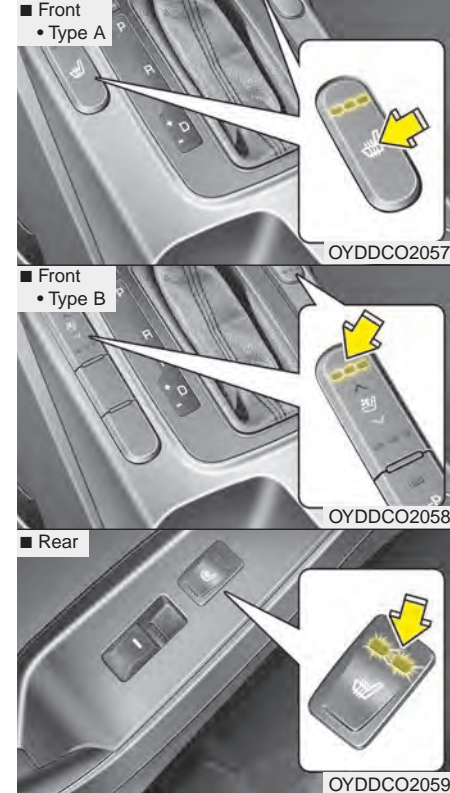

The seat warmer is provided to warm the front seats during cold weather.

With the ignition switch in the ON position, push either of the switches to warm the driver's seat or the front passenger's seat.

During mild weather or under conditions where the operation of the seat warmer is not needed, keep the switches in the OFF position.

- Each time you push the button, the temperature setting of the seat is changed as follows :

- Front seat

OFF → HIGH (☀☀☀) → MIDDLE (☀☀) → LOW (☀)



- Rear seat

OFF → HIGH (☀☀) → LOW (☀)



- The seat warmer defaults to the OFF position whenever the ignition switch is turned on.
- With the seat warmer switch in the ON position, the heating system in the seat turns off or on automatically depending on the seat temperature.

⚠ CAUTION

- *When cleaning the seats, do not use an organic solvent such as thinner, benzene, alcohol and gasoline. Doing so may damage the surface of the heater or seats.*
- *To prevent overheating the seat warmer, do not place anything on the seats that insulates against heat, such as blankets, cushions or seat covers while the seat warmer is in operation.*
- *Do not place heavy or sharp objects on seats equipped with seat warmers. Damage to the seat warming components could occur.*

⚠ WARNING - Seat warmer burns

Passengers should use extreme caution when using seat warmers due to the possibility of excess heating or burns. The seat warmer may cause burns even at low temperatures, especially if used for long periods of time. The occupants must be able to feel if the seat is becoming too warm and to turn the seat warmer off.

In particular, the driver must exercise extreme care for the following types of passengers:

1. Infants, children, elderly or disabled persons, or hospital outpatients
2. Persons with sensitive skin or those that burn easily
3. Fatigued individuals
4. Intoxicated individuals
5. Individuals taking medication that can cause drowsiness or sleepiness (sleeping pills, cold tablets, etc.)

Climate control seat (if equipped)

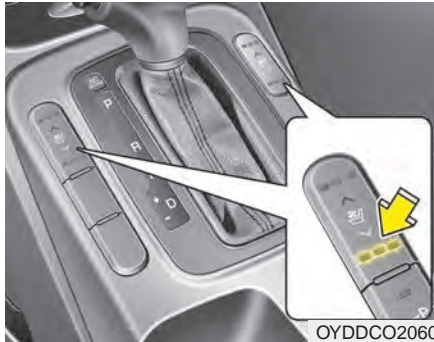

The climate control seat is provided to cool or warm the seat during hot or cold weather by blowing air through small vent holes on the surface of the seat and seatback. While the engine is running, push the rear portion of the switch (blue color) to cool the seat, and push the front portion of the switch (red color) to warm the seat.

When the operation of the climate control seat is not needed, keep the switch in the OFF position.

The climate control seat defaults to the OFF position whenever the ignition switch is turned on.

- Each time you push the button, the airflow is changed as follows:

OFF → HIGH (☀️☀️☀️) → MIDDLE (☀️☀️) → LOW (☀️)
 ↑

⚠️ CAUTION

- **The climate control seat is a supplementary cooling/heating system. Use the climate control seat when the climate control system is on. Using the climate control seat for prolonged periods of time with the climate control system off could cause the climate control seat performance to impair.**

(Continued)

(Continued)

- **When cleaning the seats, do not use an organic solvent such as paint thinner, benzene, alcohol and gasoline. Doing so may damage the surface of the seats.**
- **Do not spill liquid such as water or beverages on the surface of the front seats and seatbacks, or the air vent holes may be blocked and prevented from working properly.**
- **Do not place materials such as plastic bags or newspapers under the seats. The air vent may not work properly as the air intake can be blocked.**
- **When the air vent does not operate, restart the vehicle. If there is no change, have your vehicle inspected by an authorized Kia dealer.**

Power outlet (if equipped)

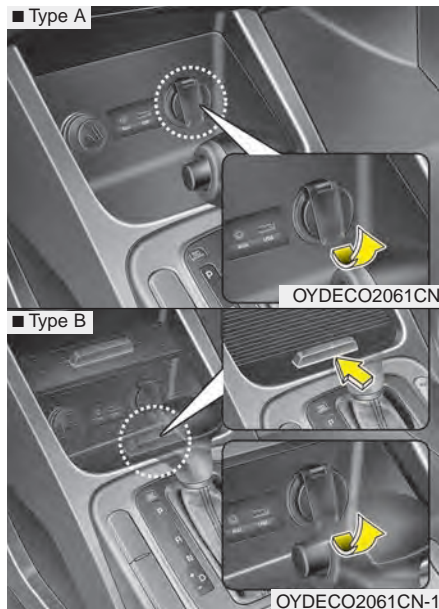

The power outlet is designed to provide power for mobile telephones or other devices designed to operate with vehicle electrical systems. The devices should draw less than 12V, 10A with the engine running.

Use the power outlet only when the engine is running and remove the accessory plug after use. Using the accessory plug for prolonged periods of time with the engine off could cause the battery to discharge.

Only use 12V electric accessories which are less than 10A in electric capacity.

Adjust the air-conditioner or heater to the lowest operating level when using the power outlet.

Close the cover when not in use.

Some electronic devices can cause electronic interference when plugged into a vehicle's power outlet. These devices may cause excessive audio static and malfunctions in other electronic systems or devices used in your vehicle.

⚠ WARNING - Electric shock
Do not put a finger or a foreign element (pin, etc.) into a power outlet and do not touch with a wet hand. You may get an electric shock.

تلفن شبانه روزی: ۰۲۱-۸۸۸۶۲۰۸۵

FarmaSOS.com

LCD monitor (clock and outside temperature)



⚠ WARNING

Do not adjust the clock while driving. You may lose your steering control.

Whenever the battery terminals or related fuses are disconnected, you must reset the time.

When the ignition switch is in the ACC or ON position, the clock buttons operate as follows:

- **HOUR (1) :**

Pressing the "H" button will advance the time display by one hour.

- **MINUTE (2) :**

Pressing the "M" button will advance the time display by one minute.

- **Display conversion:**

- Clock

To change the 12 hour format to the 24 hour format, press the "H" and "M" button at the same time for more than 4 seconds.

For example, if the time is 10:15 p.m., the display will change to 22:15.

- Outside thermometer

To change the temperature unit F to C (or C to F) press the "H" and "M" button at the same time for 1 to 3 seconds.

FarmaSOS.com

Clothes hanger (if equipped)



To use the hanger, pull down the upper portion of the hanger.

⚠ CAUTION - Hanging clothing

Do not hang heavy clothes, since those may damage the hook.

Floor mat anchor(s)

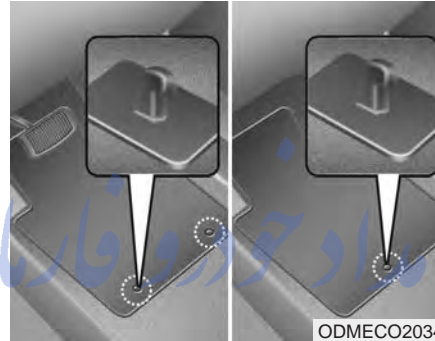

When using a floor mat on the floor carpet, make sure it attaches to the floor mat anchor(s) in the front and rear floor carpet of your vehicle. This keeps the floor mat from sliding forward.

⚠ WARNING - After market floor mat

Do not install aftermarket floor mats that are not capable of being securely attached to the vehicle's floor mat anchors. Unsecured floor mats can interfere with pedal operation.

The following must be observed when installing ANY floor mat in the vehicle.

- Ensure that the floor mats are securely attached to the vehicle's floor mat anchor(s) before driving the vehicle.
- Do not use ANY floor mat that cannot be firmly attached to the vehicle's floor mat anchors.
- Do not stack floor mats on top of one another (e.g. ,all-weather rubber mat on top of a carpeted floor mat). Only a single floor mat should be installed in each position.

IMPORTANT - Your vehicle was manufactured with driver's side floor mat anchors that are designed to securely hold the floor mat in place. To avoid any interference with pedal operation, Kia recommends that only the Kia floor mat designed for use in your vehicle be installed.

Navigation system (if equipped)

The navigation system identifies the present position of our vehicle by using GPS information and can help guide you to a selected destination.

Detailed information for the navigation system is described in a separately supplied manual.

امداد خودرو فارما

تلفن شبانه روزی: ۰۲۱-۸۸۸۶۲۰۸۵

FarmaSOS.com

AUDIO SYSTEM

* NOTICE

If you install an after market HID head lamp, your vehicle's audio and electronic device may malfunction.

Glass antenna (if equipped)



When the radio power switch is turned on while the ignition switch is in either the "ON" or "ACC" position, your car will receive both AM and FM broadcast signals through the antenna in the rear window glass.

⚠ CAUTION

- Do not clean the inside of the rear window glass with a cleaner or use a scraper to remove foreign deposits as this may cause damage to the antenna elements.
- Avoid adding metallic coatings such as Ni, Cd, and so on. These can disturb receiving AM and FM broadcast signals.

Steering wheel audio controls (if equipped)

■ Type A

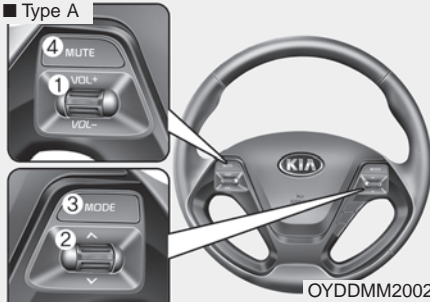

OYDDMM2002

■ Type B



OYDDMM2003

The steering wheel may incorporate audio control buttons.

⚠ WARNING

Driving while distracted is dangerous and should be avoided. Drivers should remain attentive to driving and always exercise caution when using the steering-wheel-mounted controls while driving.

⚠ CAUTION

Do not operate audio remote control buttons simultaneously.

VOLUME (+/-) (1)

- Press the lever upward (+) to increase the volume.
- Press the lever downward (-) to decrease the volume.

SEEK/PRESET (^/∨) (2)

The SEEK/PRESET button has different functions based on the system mode. For the following functions the button should be pressed for 0.8 seconds or more.

RADIO mode

It will function as the AUTO SEEK select button.

CD/USB/iPod mode

It will function as the FF/REW button.

If the SEEK/PRESET button is pressed for less than 0.8 seconds, it will work as follows in each mode.

RADIO mode

It will function as the PRESET STATION buttons.

CD/USB/iPod mode

It will function as TRACK UP/DOWN button.

MODE (3)

Press the button to change audio source.

FM(1~2)→AM→SAT(1~3)→CD→USB
AUX(iPod)→FM...

In addition to mode change, Power on/off can be made by pressing this button when the ignition switch is on ACC or ON.

- Power ON: Press the button when the audio is off
- Power OFF: Press the button for more than 0.8 seconds when the audio is on.

MUTE (4, if equipped)

- Press the button to mute the sound.
- Press the button to turn off the microphone during a telephone call.

Detailed information for audio control buttons are described in the following pages in this chapter.

Aux, USB and iPod®* port

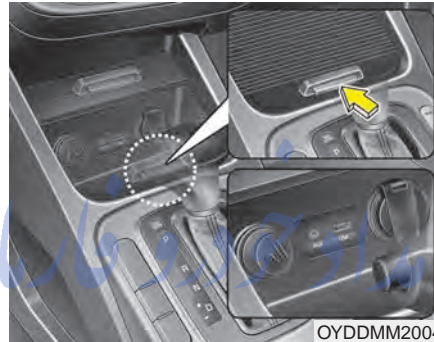

If your vehicle has an aux and/or USB(universal serial bus) port or iPod® port, you can use an aux port to connect audio devices and an USB port to plug in an USB and also an iPod® port to plug in an iPod®.

*** NOTICE**

When using a portable audio device connected to the power outlet, noise may occur during playback. If this happens, use the power source of the portable audio device.

* iPod® is a Registered trademark of Apple Inc.

How vehicle audio works

FM reception

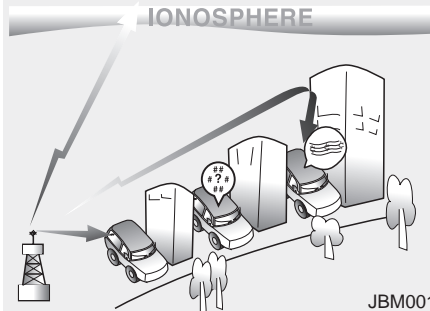

AM and FM radio signals are broadcast from transmitter towers located around your city. They are intercepted by the radio antenna on your vehicle. This signal is then processed by the radio and sent to your vehicle speakers.

When a strong radio signal has reached your vehicle, the precise engineering of your audio system ensures the best possible quality reproduction. However, in some cases the signal coming to your vehicle may not be strong and clear.

This can be due to factors, such as the distance from the radio station, closeness of other strong radio stations or the presence of buildings, bridges or other large obstructions in the area.

امداد خودرو فارما

تلفن شبانه روزی: ۰۲۱-۸۸۸۶۲۰۸۵

FarmaSOS.com

AM reception

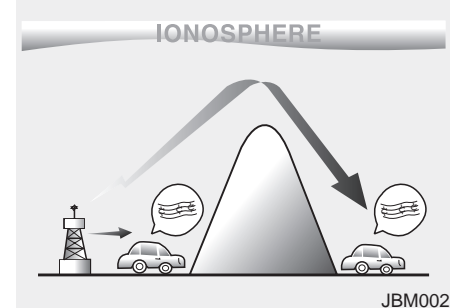

AM broadcasts can be received at greater distances than FM broadcasts. This is because AM radio waves are transmitted at low frequencies. These long distance, low frequency radio waves can follow the curvature of the earth rather than travelling straight. In addition, they curve around obstructions resulting in better signal coverage.

FM radio station

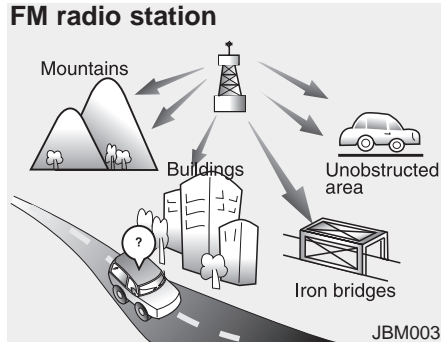

FM broadcasts are transmitted at high frequencies and do not bend to follow the earth's surface. Because of this, FM broadcasts generally begin to fade within short distances from the station. Also, FM signals are easily affected by buildings, mountains, and obstructions. This can lead to undesirable or unpleasant listening conditions which might lead you to believe a problem exists with your radio. The following conditions are normal and do not indicate radio trouble:

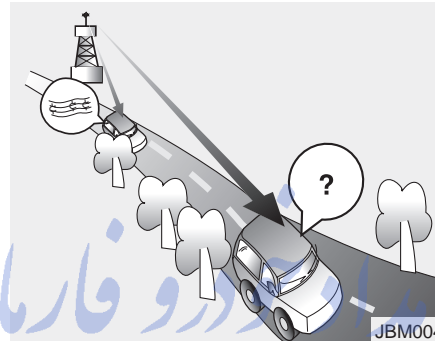

- **Fading** - As your vehicle moves away from the radio station, the signal will weaken and sound will begin to fade. When this occurs, we suggest that you select another stronger station.
- **Flutter/Static** - Weak FM signals or large obstructions between the transmitter and your radio can disturb the signal causing static or fluttering noises to occur. Reducing the treble level may lessen this effect until the disturbance clears.

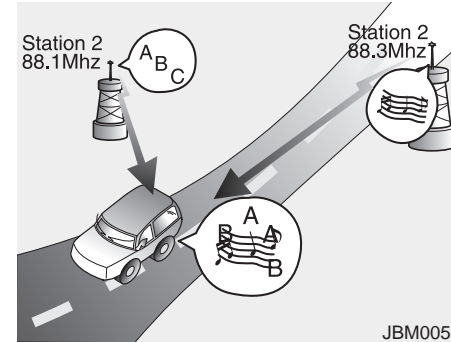

- **Station Swapping** - As an FM signal weakens, another more powerful signal near the same frequency may begin to play. This is because your radio is designed to lock onto the clearest signal. If this occurs, select another station with a stronger signal.
- **Multi-Path Cancellation** - Radio signals being received from several directions can cause distortion or fluttering. This can be caused by a direct and reflected signal from the same station, or by signals from two stations with close frequencies. If this occurs, select another station until the condition has passed.

Using a cellular phone or a two-way radio

When a cellular phone is used inside the vehicle, noise may be produced from the audio system. This does not mean that something is wrong with the audio equipment. In such a case, try to operate mobile devices as far from the audio equipment as possible.

⚠ CAUTION

When using a communication system such as a cellular phone or a radio set inside the vehicle, a separate external antenna must be fitted. When a cellular phone or a radio set is used with an internal antenna alone, it may interfere with the vehicle's electrical system and adversely affect safe operation of the vehicle.

⚠ WARNING

Do not use a cellular phone while driving. Stop at a safe location to use a cellular phone.

امداد خودرو فارما

تلفن شبانه روزی: ۰۸۵-۸۸۸۶۲۰۲۱

FarmaSOS.com

Caring for disc

- If the temperature inside the car is too high, open the car windows to ventilate before using the system.
- It is illegal to copy and use MP3/WMA files without permission. Use CDs that are created only by lawful means.
- Do not apply volatile agents, such as benzene and thinner, normal cleaners and magnetic sprays made for analogue disc onto CDs.
- To prevent the disc surface from getting damaged, hold CDs by the edges or the center hole only.
- Clean the disc surface with a piece of soft cloth before playback (wipe it from the center to the outside edge).
- Do not damage the disc surface or attach pieces of sticky tape or paper.
- Make certain only CDs are inserted into the CD player (Do not insert more than one CD at a time).
- Keep CDs in their cases after use to protect them from scratches or dirt.

- Depending on the type of CD-R/CD-RW CDs, certain CDs may not operate normally according to the manufacturing companies. In such circumstances, continued use may cause malfunctions to your audio system.

* NOTICE

- Playing an Incompatible Copy Protected Audio CD

Some copy protected CDs, which do not comply with international audio CD standards (Red Book), may not play on your car audio. Please note that inability to properly play a copy protected CD may indicate that the CD is defective, not the CD player.

NOTE:

Order of playing files (folders) :

1. Song playing order : ① to ⑭

2. Folder playing order :

* If no song file is contained in the folder, that folder is not displayed.

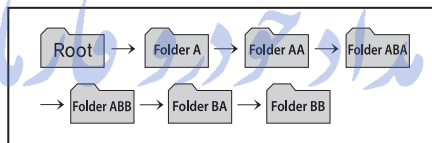

تلفن شبانه روزی: ۰۲۱-۸۸۸۶۲۰۸۵

FarmaSOS.com

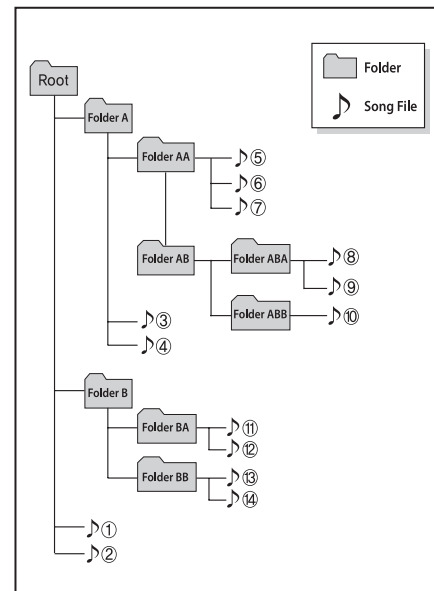

⚠ WARNING

- Do not stare at the screen while driving. Staring at the screen for prolonged periods of time could lead to traffic accidents.
- Do not disassemble, assemble, or modify the audio system. Such acts could result in accidents, fire, or electric shock.
- Using the phone while driving may lead to a lack of attention of traffic conditions and increase the likelihood of accidents. Use the phone feature after parking the vehicle.
- Heed caution not to spill water or introduce foreign objects into the device. Such acts could lead to smoke, fire, or product malfunction.

(Continued)

(Continued)

- Please refrain from use if the screen is blank or no sound can be heard as these signs may indicate product malfunction. Continued use in such conditions could lead to accidents (fires, electric shock) or product malfunctions.
- Do not touch the antenna during thunder or lightening as such acts may lead to lightning induced electric shock.
- Do not stop or park in parking-restricted areas to operate the product. Such acts could lead to traffic accidents.
- Use the system with the vehicle ignition turned on. Prolonged use with the ignition turned off could result in battery discharge.

⚠ CAUTION

- *Operating the device while driving could lead to accidents due to a lack of attention to external surroundings. First park the vehicle before operating the device.*
- *Adjust the volume to levels that allow the driver to hear sounds from outside of the vehicle. Driving in a state where external sounds cannot be heard may lead to accidents.*
- *Pay attention to the volume setting when turning the device on. A sudden output of extreme volume upon turning the device on could lead to hearing impairment. (Adjust the volume to a suitable levels before turning off the device.)*

(Continued)

(Continued)

- *If you want to change the position of device installation, please inquire with your place of purchase or service maintenance center. Technical expertise is required to install or disassemble the device.*
- *Turn on the car ignition before using this device. Do not operate the audio system for long periods of time with the ignition turned off as such operations may lead to battery discharge.*
- *Do not subject the device to severe shock or impact. Direct pressure onto the front side of the monitor may cause damage to the LCD or touch screen.*

(Continued)

(Continued)

- *When cleaning the device, make sure to turn off the device and use a dry and smooth cloth. Never use tough materials, chemical cloths, or solvents (alcohol, benzene, thinners, etc.) as such materials may damage the device panel or cause color/quality deterioration*
- *Do not place beverages close to the audio system. Spilling beverages may lead to system malfunction.*
- *In case of product malfunction, please contact your place of purchase or After Service center.*
- *Placing the audio system within an electromagnetic environment may result in noise interference.*



CAUTION

Prevent caustic solutions such as perfume and cosmetic oil from contacting the dashboard because they may cause damage or discoloration.

USING THE USB DEVICE

- To use an external USB device, make sure the device is not connected when starting up the vehicle. Connect the device after starting up.
- If you start the engine when the USB device is connected, it may damage the USB device. (USB flashdrives are very sensitive to electric shock.)
- If the engine is started up or turned off while the external USB device is connected, the external USB device may not work.
- The System may not play unauthenticated MP3 or WMA files.
 - 1) It can only play MP3 files with the compression rate between 8Kbps ~ 320Kbps.
 - 2) It can only play WMA music files with the compression rate between 8Kbps ~ 320Kbps.
- Take precautions for static electricity when connecting or disconnecting the external USB device.

(Continued)

(Continued)

- An encrypted MP3 PLAYER is not recognizable.
- Depending on the condition of the external USB device, the connected external USB device can be unrecognizable.
- When the formatted byte/sector setting of External USB device is not either 512BYTE or 2048BYTE, then the device will not be recognized.
- Use only a USB device formatted to FAT 12/16/32.
- USB devices without USB I/F authentication may not be recognizable.
- Make sure the USB connection terminal does not come in contact with the human body or other objects.
- If you repeatedly connect or disconnect the USB device in a short period of time, it may break the device.

(Continued)

(Continued)

- You may hear a strange noise when connecting or disconnecting a USB device.
- If you disconnect the external USB device during playback in USB mode, the external USB device can be damaged or may malfunction. Therefore, disconnect the external USB device when the audio is turned off or in another mode. (e.g, Radio, CD)
- Depending on the type and capacity of the external USB device or the type of the files stored in the device, there is a difference in the time taken for recognition of the device.
- Do not use the USB device for purposes other than playing music files.
- Playing videos through the USB is not supported.
- Use of USB accessories such as rechargers or heaters using USB I/F may lower performance or cause trouble.

(Continued)

(Continued)

- If you use devices such as a USB hub purchased separately, the vehicle's audio system may not recognize the USB device. In that case, connect the USB device directly to the multimedia terminal of the vehicle.
- If the USB device is divided by logical drives, only the music files on the highest-priority drive are recognized by car audio.
- Devices such as MP3 Player/ Cellular phone/Digital camera can be unrecognizable by standard USB I/F can be unrecognizable.
- Charging through the USB may not be supported in some mobile devices.
- USB HDD or USB types liable to connection failures due to vehicle vibrations are not supported. (i-stick type)
- Some non-standard USB devices (METAL COVER TYPE USB) can be unrecognizable.

(Continued)

(Continued)

- Some USB flash memory readers (such as CF, SD, micro SD, etc.) or external-HDD type devices can be unrecognizable.
- Music files protected by DRM (DIGITAL RIGHTS MANAGEMENT) are not recognizable.
- The data in the USB memory may be lost while using this audio. Always back up important data on a personal storage device.
- Please avoid using USB memory products which can be used as key chains or cellular phone accessories as they could cause damage to the USB jack. Please make certain only to use plug type connector products.



USING THE iPod® DEVICE

- Some iPod® models may not support communication protocol and files may not properly play.
Supported iPod® models:
 - iPhone® 3GS/4
 - iPod® touch 1st~4th generation
 - iPod® nano 1st~6th generation
 - iPod® classic
- The order of search or playback of songs in the iPod® can be different from the order searched in the audio system.
- If the iPod® is disabled due to its own malfunction, reset the iPod®. (Reset: Refer to iPod® manual)
- An iPod® may not operate normally on low battery.

(Continued)

(Continued)

- Some iPod® devices, such as the iPhone, can be connected through the *Bluetooth®* Wireless Technology interface. The device must have audio *Bluetooth®* Wireless Technology capability (such as for stereo headphone *Bluetooth®* Wireless Technology).
The device can play, but it will not be controlled by the audio system.
- To use iPod® features within the audio, use the cable provided upon purchasing an iPod® device.
- Skipping or improper operation may occur depending on the characteristics of your iPod®/Phone device.
- If your iPhone is connected to both the *Bluetooth®* Wireless Technology and USB, the sound may not be properly played. In your iPhone, select the Dock connector or *Bluetooth®* Wireless Technology to change the sound output (source).

(Continued)

(Continued)

- When connecting iPod® with the iPod® Power Cable, insert the connector to the multimedia socket completely. If not inserted completely, communications between iPod® and audio may be interrupted.
- When adjusting the sound effects of the iPod® and the audio system, the sound effects of both devices will overlap and might reduce or distort the quality of the sound.
- Deactivate (turn off) the equalizer function of an iPod® when adjusting the audio system's volume, and turn off the equalizer of the audio system when using the equalizer of an iPod®.
- When not using iPod® with car audio, detach the iPod® cable from iPod®. Otherwise, iPod® may remain in accessory mode, and may not work properly.

Bluetooth® Wireless Technology

Bluetooth® Wireless Technology

The *Bluetooth®* word mark and logos are registered trademarks owned by Bluetooth SIG, Inc. and any use of such marks by Kia is under license.

A *Bluetooth®* enabled call phone is required to use *Bluetooth®* wireless technology.

⚠ WARNING

- **Driving while distracted can result in a loss of vehicle control that may lead to an accident, severe personal injury, and death. The driver's primary responsibility is in the safe and legal operation of a vehicle, and use of any handheld devices, other equipment, or vehicle systems which take the driver's eyes, attention and focus away from the safe operation of a vehicle or which are not permissible by law should never be used during operation of the vehicle.**

Before Using the Bluetooth® Handsfree

What is Bluetooth® ?

- *Bluetooth®* refers to a short-distance wireless networking technology which uses a 2.45GHz frequency to connect various devices within a certain distance.
- Supported within PCs, external devices, *Bluetooth®* phones, PDAs, various electronic devices, and automotive environments, *Bluetooth®* allows data to be transmitted at high speeds without having to use a connector cable.
- *Bluetooth®* Handsfree refers to a device which allows the user to conveniently make phone calls with *Bluetooth®* mobile phones through the AV/Navigation system.
- *Bluetooth®* Handsfree may not be supported in some mobile phones. To learn more about mobile device compatibility, visit www.kia.com.

Precautions for Safe Driving

- *Bluetooth®* Handsfree is a feature that enables drivers to practice safe driving. Connecting the head unit with a *Bluetooth®* phone allows the user to conveniently make and receive calls and use contacts. Before using *Bluetooth®*, carefully read the contents of this user's manual.
- Excessive use or operations while driving may lead to negligent driving practices and result in accidents. Refrain from excessive operations while driving.
- Viewing the screen for prolonged periods of time is dangerous and may lead to accidents. When driving, view the screen only for short periods of time.

When connecting a *Bluetooth*[®] Phone

- Before connecting the head unit with the mobile phone, check to see that the mobile phone supports *Bluetooth*[®] features.
- Even if the phone supports *Bluetooth*[®], the phone will not be found during device searches if the phone has been set to hidden state or the *Bluetooth*[®] power is turned off. Disable the hidden state or turn on the *Bluetooth*[®] power prior to searching/connecting with the Head unit.
- *Bluetooth* phone is automatically connected when the ignition on.
- If you do not want automatic connection with your *Bluetooth*[®] device, turn off the *Bluetooth*[®] feature within your mobile phone.
- The Handsfree call volume and quality may differ depending on the mobile phone.
- Park the vehicle when connecting the head unit with the mobile phone.
- *Bluetooth*[®] connection may become intermittently disconnected in some mobile phones. Follow these steps to try again.
 1. Within the mobile phone, turn the *Bluetooth*[®] function off/on and try again.
 2. Turn the mobile phone power Off/On and try again.
 3. Completely remove the mobile phone battery, reboot, and then again.
 4. Reboot the Audio Video Navigation System and try again.
 5. Delete all paired devices, pair and try again.
- Handsfree call quality and volume may differ depending on the model of your mobile phone.

Voice Recognition

- When using the voice recognition feature, only commands listed within the user's manual are supported.
- Be aware that during the operation of the voice recognition system, pressing any key other than the  key terminate voice recognition mode.
- For superior voice recognition performance, position the microphone used for voice recognition above the head of the driver's seat and maintain a proper position when saying commands.
- Within the following situations, voice recognition may not function properly due to external sound.
 - When the windows and sunroof are open
 - When the wind of the cooling / heating device is strong
 - When entering and passing through tunnels

(Continued)

(Continued)

- When driving on rugged and uneven roads
- During severe rain (heavy rains, windstorms)
- Phone related voice commands can be used only when a *Bluetooth*® Wireless Technology device is connected.
- When making calls by stating a name, the corresponding contact must be downloaded and stored within the audio system.
- After downloading the *Bluetooth*® Wireless Technology phone book, it takes some times to convert the phone book data into voice information. During this time, voice recognition may not properly operate.
- Pronounce the voice commands naturally and clearly as if in a normal conversation.

■ CD Player : AM171A7KN, AM1A1A7KN, AM171A7AN, AM1A1A7AN, AM101A7KN, AM111A7KN



* No  Bluetooth logo will be shown if the *Bluetooth*® Wireless Technology feature is not supported.

SYSTEM CONTROLLERS AND FUNCTIONS

* Display and settings may differ depending on the selected audio.

Audio Head Unit





(1)  (EJECT)
Ejects the disc.

(2) RADIO

Changes to FM/AM/SIRIUS™ mode. Each time the key is pressed, the mode is changed in order of FM1 → FM2 → AM → SAT1 → SAT2 → SAT3.

* In Setup>Display, the radio pop up screen will be displayed when [Mode Pop up] is turned .



When the pop up screen is displayed, use the  TUNE knob or keys  ~  to select the desired mode.

(3) MEDIA

Changes to CD, USB(iPod®), AUX, My Music, BT Audio mode.

Each time the key is pressed, the mode is changed in order of CD, USB(iPod®), AUX, My Music, BT Audio.

* In Setup>Display, the media pop up screen will be displayed when [Mode Pop up] is turned .

When the pop up screen is displayed, use the  TUNE knob or keys  ~  to select the desired mode.

(4) PHONE

Operates Phone Screen

* When a phone is not connected, the connection screen is displayed.

(5)

Radio Mode : Automatically searches for broadcast frequencies.

CD, USB, iPod®, My Music modes

- Shortly press the key (under 0.8 seconds): Moves to next or previous song (file)

- Press and hold the key (over 0.8 seconds): Rewinds or fast-forwards the current song.

BT Audio mode : Moves to next or previous song(file)

* The Play/Pause feature may operate differently depending on the mobile phone.

(6) PWR/VOL knob

 Power : Turns power On/Off by pressing the knob

 Volume : Sets volume by turning the knob left/right



(7) **DISP**

Each time the button is shortly pressed (under 0.8 seconds), it sets the screen Off → Screen On → Screen Off

* Audio operation is maintained and only the screen will be turned Off. In the screen Off state, press any key to turn the screen On again.

(8) **SCAN**

Radio Mode

- Shortly press the key : Previews each broadcast for 5 seconds each.

- Press and hold the key (over 0.8 seconds): Previews the broadcasts saved in Preset **1** ~ **6** for 5 seconds each.

* Press the **SCAN** key again to continue listening to the current frequency.

* SAT Radio does not support the Preset scan feature.

CD, USB, My Music mode, *تلفن شبانه روز*

- Shortly press the key (under 0.8 seconds): Previews each song (file) for 10 seconds each.

* Press the **SCAN** key again to continue listening to the current song (file).

(9) **SETUP**

Moves to the Display, Sound, Phone, System setting modes.

(10) **MENU**

Displays menus for the current mode.

(11) **CAT FOLDER**

Radio Mode

- SIRIUS™ RADIO : Category Search

MP3, CD, USB mode : Folder Search

(12) **TUNE** knob

Radio mode : Changes frequency by turning the knob left/right.

CD, USB, iPod®, My Music mode: Searches songs (files) by turning the knob left/right.

* When the desired song is displayed, press the knob to play the song.

Moves focus in all selection menus and selects menus.

Features of your vehicle

(13) **1** ~ **6** (Preset)

Radio Mode: Saves frequencies (channels) or receives saved frequencies (channels)

CD, USB, iPod®, My Music mode

- **1** : Repeat

- **2** : Random

In the Radio, Media, Setup, and Menu pop up screen, the number menu is selected.



(14) **FM/AM** تلفن شبانه روزی: ۰۸۵۰۶۲۰۸۵

Changes to FM/AM mode.

Each time the key is pressed, the mode is changed in order of FM1 → FM2 → AM.

(15) **SAT**

Changes to SIRIUS™ Satellite Radio mode.

Each time the key is pressed, the mode is changed in order of SAT1 → SAT2 → SAT3.

SETUP

Display Settings

Press the **SETUP** key ▶ Select [Display] through **TUNE** knob or **1** key ▶ Select menu through **TUNE** knob

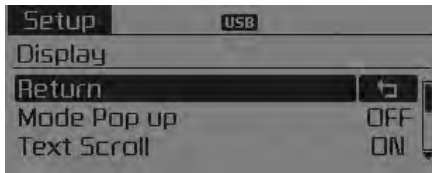

Mode Pop up

[Mode Pop up] ▶ Changes On / Off selection mode

- During On state, press the **RADIO** or **MEDIA** key to display the mode change pop up screen.

Text Scroll

[Text Scroll] ▶ Set On / Off

- On : Maintains scroll
- Off : Scrolls only one (1) time.

Media Display

When playing an MP3 file, select the desired display info from 'Folder/File' or 'Album/Artist/Song'.



SOUND SETTINGS

Press the **SETUP** key ▶ Select [Sound] through **TUNE** knob or **2** key ▶ Select menu through **TUNE** knob

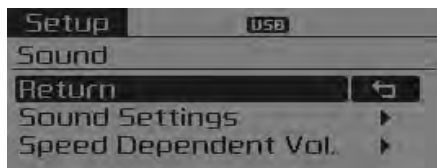

Sound Settings

This menu allows you to set the 'Bass, Middle, Treble' and the Sound Fader and Balance.

Select [Sound Settings] ▶ Select menu through **TUNE** knob ▶ Turn **TUNE** knob left/right to set

- Bass, Middle, Treble : Selects the sound tone.
- Fader, Balance : Moves the sound fader and balance.
- Default : Restores default settings.
- * Back : While adjusting values, pressing the **TUNE** knob will restore the parent menu.



Speed Dependent Volume Control

This feature is used to automatically control the volume level according to the speed of the vehicle.

Select [Speed Dependent Vol.] ▶ Set in 4 levels [Off/Low/Mid/High] of **TUNE** knob

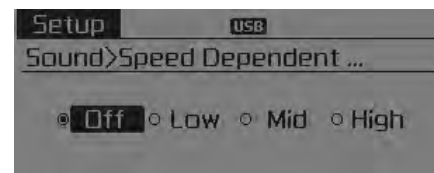

Voice Recognition Volume

Adjusts voice recognition volume.

Select [Voice Recognition Vol.] ▶ Set volume of **TUNE** knob



SYSTEM SETTINGS

Press the **SETUP** key ▶ Select [System] through tune knob or **4** key ▶ Select menu through **TUNE** knob

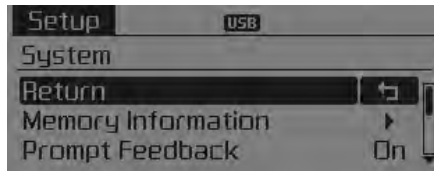

Memory Information

Displays currently used memory and total system memory.

Select [Memory Information] ▶ OK

The currently used memory is displayed on the left side while the total system memory is displayed on the right side.



Prompt Feedback

This feature is used to change voice command feedback between Normal and Expert modes.

Select [Prompt Feedback] ▶ Set through **TUNE** knob

- On : This mode is for beginner users and provides detailed instructions during voice command operation.

- Off : This mode is for expert users and omits some information during voice command operation. (When using Expert mode, guidance instructions can be heard through the [Help] or [Menu] commands.)

Language

This menu is used to set the display and voice recognition language.

Select [Language] ▶

Set through **TUNE** knob

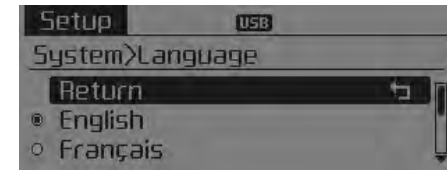

- * The system will reboot after the language is changed.
- * Language support by region
 - English, Francais, Espanol

RADIO : FM, AM OR SIRIUS™

Changing RADIO mode (FM, AM or SIRIUS™)

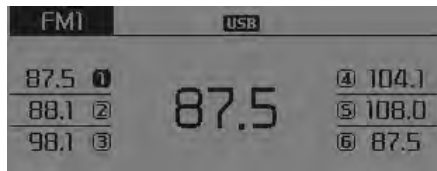

Press the **RADIO** key to change the mode in order of FM1→FM2→AM→SAT1→SAT2→SAT3.

- When the power is off, press the **RADIO** key to turn on the audio system and receive radio broadcasts.
- [Mode Pop up] On state : Displays the change radio mode pop up screen. While the pop up screen is displayed, you can change the radio mode (FM1→FM2→AM→SAT1→SAT2→SAT3) through the tune knob or **1** ~ **6** keys.

Adjust Volume

Turn the **VOL** knob left/right to adjust the volume.

SEEK

Press the **SEEK TRACK** key

- Shortly pressing the key (under 0.8 seconds): Automatically searches for the next station.
- Pressing and holding the key (over 0.8 seconds): While holding the key, frequency changes without stopping. When the key is released, automatically searches for the next frequency from that point.

Preset SEEK

Press the **1** ~ **6** key

- Shortly pressing the key (under 0.8 seconds): Plays the frequency saved in the corresponding key.
- Pressing and holding the key (over 0.8 seconds): Pressing and holding the desired key from **1** ~ **6** will save the currently playing broadcast to the selected key and sound a BEEP.

SCAN

Press the **SCAN** key

- Shortly pressing the key (under 0.8 seconds): The broadcast frequency increases and previews each broadcast for 5 seconds each. After scanning all frequencies, returns and plays the current broadcast frequency.
- Pressing and holding the key (over 0.8 seconds): Previews the broadcasts saved in Preset **1** ~ **6** for 5 seconds each.

Selecting through manual search

Turn the **TUNE** knob left/right to adjust the frequency.

- FM : Changes by 200KHz
- AM : Changes by 10KHz

MENU

Within **MENU** key are the A.Store (Auto Store) and Info functions.

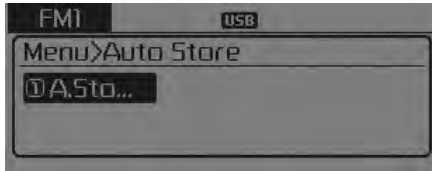

1 A.Store

Press the **MENU** key ▶ Set [A.Store] through **TUNE** knob or **1** key.

Saves broadcasts with superior reception to **1** ~ **6** keys. If no frequencies are received, then the most recently received frequency will be broadcast.

امداد خودرو فارما

تلفن شبانه روزی: ۰۲۱-۸۸۸۶۲۰۸۵

FarmaSOS.com

SIRIUS™ Satellite Radio information

Satellite Radio channels:

SIRIUS™ Satellite Radio has over 130 channels, including 69 channels of 100% commercial-free music, plus sports, news, talk and entertainment available nationwide in your vehicle. For more information and a complete list of SIRIUS™ Satellite Radio channels, visit sirius.com in the United States, sirius-canada.ca in Canada, or call SIRIUS™ at 1-888-539-7474.

Satellite Radio reception factors:

To receive the satellite signal, your vehicle has been equipped with a satellite radio antenna located on the roof of your vehicle. The vehicle roof provides the best location for an unobstructed, open view of the sky, a requirement of a satellite radio system. Like AM/FM, there are several factors that can affect satellite radio reception performance:

- Antenna obstructions: For optimal reception performance, keep the antenna clear of snow and ice build-up and keep luggage and other material as far away from the antenna as possible.
- Terrain: Hills, mountains, tall buildings, bridges, tunnels, freeway over-

passes, parking garages, dense tree foliage and thunderstorms can interfere with your reception.

SIRIUS™ Satellite Radio service:

SIRIUS™ Satellite Radio is a subscription-based satellite radio service that broadcasts music, sports, news and entertainment programming to radio receivers, which are available for installation in motor vehicles or factory installed, as well as for the home, portable and wireless devices, and through an Internet connection on personal computer.

Vehicles that are equipped with a factory installed SIRIUS™ Satellite Radio system include:

- Hardware and an introductory trial subscription term, which begins on the date of sale or lease of the vehicle.
- For a small upgrade fee, access to SIRIUS™ music channels, and other select channels over the Internet using any computer connected to the Internet (U.S. customers only).

For information on extended subscription terms, contact SIRIUS™ at 1-888-539-7474.

NOTE:

SiriusXM service requires a subscription, sold separately, after 3-month trial included with vehicle purchase. If you decide to continue your SiriusXM service at the end of your trial subscription, the plan you choose will automatically renew and bill at then-current rates until you call Sirius XM at 1-866-635-2349 to cancel. See our Customer Agreement for complete terms at www.siriusxm.com. Programming subject to change. Sirius satellite service is available only to those at least 18 and older in the 48 contiguous USA, D.C., and PR (with coverage limitations). Traffic information not available in all markets. See siriusxm.com/traffic for details.

Sirius, XM and all related marks and logos are trademarks of Sirius XM Radio Inc.

SIRIUS™ RADIO

Using SIRIUS™ Satellite Radio

Your Kia vehicle is equipped with a 3 month complimentary period of SIRIUS™ Satellite Radio so you have access to over 130 channels of music, information, and entertainment programming.

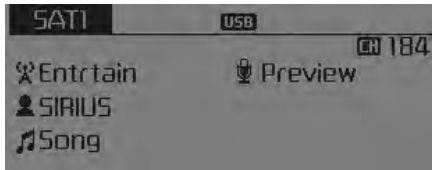

Activation

In order to extend or reactivate your subscription to SIRIUS™ Satellite Radio, you will need to contact SIRIUS™ Customer Care at 1-888-539-7474. Have your 12 digit SID (Sirius Identification Number) / ESN (Electronic Serial Number) ready. To retrieve the SID / ESN, turn on the radio, press the [RADIO] button, and tune to channel zero.

Please note that the vehicle will need to be turned on, in Sirius mode, and have an unobstructed view of the sky in order for the radio to receive the activation signal.

SEEK

Press the **RADIO** key ▶

- Shortly pressing the key (under 0.8 seconds): select previous or next channel.
- Pressing and holding the key (over 0.8 seconds): continuously move to previous or next channel.
- * If the “Category” icon is displayed, channels are changed within the current category.



SCAN

Press the **RADIO** key ▶ **SCAN**

- Shortly pressing the key (under 0.8 seconds): Previews each broadcast for 5 seconds each
- * Press the **SCAN** key again to continue listening to the current frequency
- * If the “Category” icon is displayed, channels are changed within the current category.

Category

Press the **CAT** key ▶ Set through the **TUNE** knob

- The display will indicate the category menus, highlight the category that the current channel belongs to.
- In the Category List Mode, press the **CAT** key to navigate category list.
- Press the tune knob to select the lowest channel in the highlighted category.
- * If channel is selected by selecting category, then the “CATEGORY” icon is displayed at the top of the screen.

Preset

Press the **RADIO** key ▶ **1** ~ **6**

- Shortly pressing the key (under 0.8 seconds): Plays the frequency saved in the corresponding key.
- Pressing and holding the key (over 0.8 seconds): Pressing and holding the desired key from **1** ~ **6** will save the current broadcast to the selected key and sound a BEEP.

* Troubleshooting

1. Antenna Error

If this message is displayed, the antenna or antenna cable is broken or unplugged. Please consult with your Kia dealership.

2. Acquiring Signal

If this message is displayed, it means that the antenna is covered and that the SIRIUS™ Satellite Radio signal is not available. Ensure the antenna is uncovered and has a clear view of the sky.

Tune

- Rotate **TUNE** knob : Changes the channel number or scrolls category list.
- Press **TUNE** knob : Selects the menu.

Menu

Select category menu through the **TUNE** knob ▶ Press the **MENU** key ▶ Select [**Info**] through the **TUNE** knob or **1** key

Info (Information)

Displays the Artist/Song info of the current song.

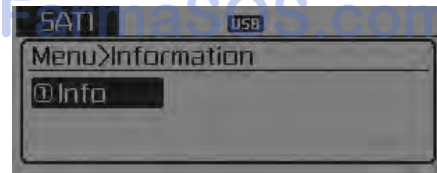

BASIC METHOD OF USE :

Audio CD / MP3 CD / USB / iPod® / My Music

Press the **MEDIA** key to change the mod mode in order of CD → USB(iPod®) → AUX → My Music → BT Audio.

The folder/file name is displayed on the screen.

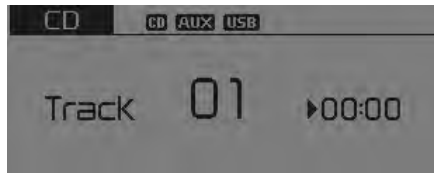

<Audio CD>



<CD MP3>

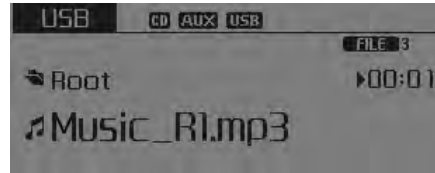

<USB>

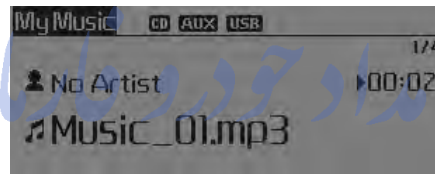

<My Music>

* The CD is automatically played when a CD is inserted.

* The USB music is automatically played when a USB is connected.

Repeat

While song (file) is playing ▶ **1 RPT** (RPT) key

Audio CD, MP3 CD, USB, iPod®, My Music mode: RPT on screen

- To repeat one song (press the key) : Repeats the current song.

MP3 CD, USB mode: FLD.RPT on screen

- To repeat folder (pressing twice): repeats all files within the current folder.

* Press the **1 RPT** key again to turn off repeat.

Random

While song (file) is playing ▶ **2 RDM** (RDM) key

Audio CD, My Music mode: RDM on screen

- Random (press the key) : Plays all songs in random order.

MP3 CD, USB mode: FLD.RDM on screen

- Folder Random (press the key) : Plays all files within the current folder in random order.

iPod® mode: ALL RDM on screen

- All Random (press the key) : Plays all files in random order.

MP3 CD, USB : ALL RDM on screen

- All Random (pressing twice): Plays all files in random order.

- * Press the **2RDM** key again to turn off repeat.

Changing Song/File

While song (file) is playing ▶ **SEEK TRACK** key

- Shortly pressing the key : Plays the current song from the beginning.

- * If the **SEEK TRACK** key is pressed again within 2 second, the previous song is played.

- Pressing and holding the key (over 0.8 seconds): Rewinds the song.

While song (file) is playing ▶ **SEEK TRACK** key

- Shortly pressing the key : Plays the next song.
- Pressing and holding the key (over 0.8 seconds): Fast forwards the song.

Scan

While song (file) is playing ▶ **SCAN** key

- Shortly pressing the key : Scans all songs from the next song for 10 seconds each.

- * Press the **SCAN** key again to turn off.

- * The SCAN function is not supported in iPod® mode.

Folder Search : MP3 CD, USB Mode

While file is playing ▶ **CAT FOLDER** (Folder Up) key

- Searches the next folder.

While file is playing ▶ **CAT FOLDER** (Folder Down) key

- Searches the parent folder.

- * If a folder is selected by pressing the **TUNE** knob, the first file within the selected folder will be played.

- * In iPod® mode, moves to the Parent Folder.

Searching Songs (File)

- Turning **TUNE** knob : Searches for songs (files)

- Pressing **TUNE** knob : Plays selected song (file).

MENU : Audio CD

Press the CD MP3 mode **MENU** key to set the Repeat, Random, Information features.



Repeat

Press the **MENU** key ▶ Set [**1 RPT**] through the **TUNE** knob or **1 RPT** key to repeat the current song.

* Press RPT again to turn off.

Random

Press the **MENU** key ▶ Set [**2 RDM**] through the **TUNE** knob or **2 RDM** key to randomly play songs within the current folder.

* Press RDM again to turn off.

Information

Press the **MENU** key ▶ Set [**3 Info**] through the **TUNE** knob or **3** key to display information of the current song.

* Press the **MENU** key to turn off info display.

امداد خودرو فارما

تلفن شبانه روزی: ۰۲۱-۸۸۸۶۲۰۸۵

FarmaSOS.com

MENU : MP3 CD / USB

Press the CD MP3 mode **MENU** key to set the Repeat, Folder Random, Folder Repeat, All Random, Information, and Copy features.



Repeat

Press the **MENU** key ▶ Set [**1 RPT**] through the **TUNE** knob or **1 RPT** key to repeat the current song.

* Press RPT again to turn off.

Folder Random

Press the **MENU** key ▶ Set [**2**] F.RDM] through the **TUNE** knob or **2 RDM** key to randomly play songs within the current folder.

* Press F.RDM again to turn off.

Folder Repeat

Press the **MENU** key ▶ Set [**3**] F.RPT] through the **TUNE** knob or **3** key to repeat songs within the current folder.

* Press F.RPT again to turn off.

All Random

Press the **MENU** key ▶ Set [**4**] A.RDM] through the **TUNE** knob or **4** key to randomly play all songs within the CD.

* Press A.RDM again to turn off.

Information

Press the **MENU** key ▶ Set [**5**] Info] through the **TUNE** knob or **5** key to display information of the current song.

* Press the **MENU** key to turn off info display.

امداد خودرو فارما

تلفن شبانه روزی: ۰۲۱-۸۸۸۶۲۰۸۵

FarmaSOS.com

Copy

Press the **MENU** key ▶ Set [**6**] Copy] through the **TUNE** knob or **6** key.

This is used to copy the current song into My Music. You can play the copied Music in My Music mode.

* If another key is pressed while copying is in progress, a pop up asking you whether to cancel copying is displayed.

* If another media is connected or inserted (USB, CD, iPod®, AUX) while copying is in progress, copying is canceled.

* Music will not be played while copying is in progress.

MENU : iPod®

In iPod® mode, press the **MENU** key to set the Repeat, Album Random, All Random, Information and Search features.

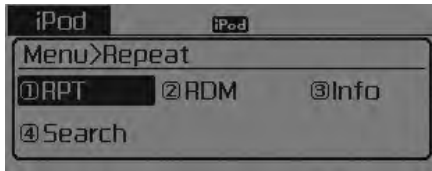
**Repeat**

Press the **MENU** key ▶ Set [**1**RPT] through the **TUNE** knob or **1 RPT** key to repeat the current song.

* Press RPT again to turn repeat off.

Random

Press the **MENU** key ▶ Set [**2**RDM] through the **TUNE** knob or **2** key.

Plays all songs within the currently playing category in random order.

* Press RDM again to turn off.

Information

Press the **MENU** key ▶ Set [**3**Info] through the **TUNE** knob or **3** key.

Displays information of the current song.

* Press the **MENU** key to turn off info display.

Search

Press the **MENU** key ▶ Set [**4**Search] through the **TUNE** knob or **4** key.

Displays iPod® category list.

* Searching iPod® category is **MENU** key pressed, move to parent category.

FarmaSOS.com

MENU : My Music Mode

In My Music mode, press the **MENU** key to set the Repeat, Random, Information, Delete, Delete All, and Delete Selection features.



Repeat

Press the **MENU** key ▶ Set [**1**RPT] through the **TUNE** knob or **1 RPT** key.

Repeats the currently playing song.

* Press RPT again to turn repeat off.

Random

Press the **MENU** key ▶ Set [**2**RDM] through the **TUNE** knob or **2 RDM** key.

Plays all songs in random order.

* Press RDM again to turn random off.

Information

Press the **MENU** key ▶ Set [**3**Info] through the **TUNE** knob or **3** key.

Displays information of the current song.

* Press the **MENU** key to turn off info display.

Delete

Press the **MENU** key ▶ Set [**4**Delete] through the **TUNE** knob or **4** key.

Deletes currently playing file
In the play screen, pressing delete will delete the currently playing song.

Deletes file from list

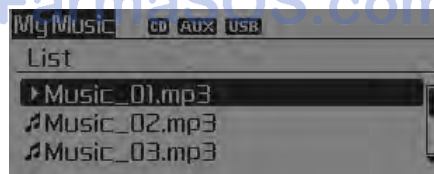

① Select the file you wish to delete by using the **TUNE** knob.

② Press the **MENU** key and select the delete menu to delete the selected file.

Delete All

Press the **MENU** key ▶ Set [**5**Del.All] through the **TUNE** knob or **5** key.

Deletes all songs of My Music.

Delete Selection

Press the **MENU** key ▶ Set [**6**Del.Sel] through the **TUNE** knob or **6** key.

Songs within My Music are selected and deleted.

① Select the songs you wish to delete from the list.

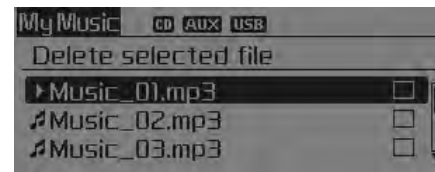

- ② After selecting, press **MENU** key and select the delete menu.

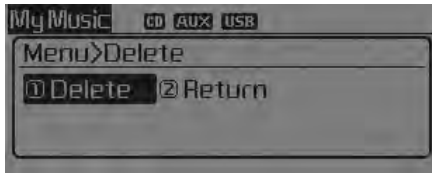

My Music

- Even if memory is available, a maximum of 6,000 songs can be stored.
- The same song can be copied up to 1,000 times.
- Memory info can be checked in the System menu of Setup.

AUX

AUX is used to play external MEDIA currently connected with the AUX terminal.

AUX mode will automatically start when an external device is connected with the AUX terminal.

If an external device is connected, you can also press the **MEDIA** key to change to AUX mode.



* AUX mode cannot be started unless there is an external device connected to the AUX terminal.

AUX

Fully insert the AUX cable into the AUX terminal for use.

Bluetooth® Wireless Technology AUDIO

What is Bluetooth® Wireless Technology?

Bluetooth® Wireless Technology allows devices to be connected in a short distance, including hands-free devices, stereo headsets, wireless remote controllers, etc. For more information, visit the *Bluetooth®* Wireless Technology website at www.Bluetooth.com

Before using *Bluetooth®* Wireless Technology audio features

- *Bluetooth®* Wireless Technology audio may not be supported depending on the compatibility of your *Bluetooth®* Wireless Technology mobile phone.
- In order to use *Bluetooth®* Wireless Technology audio, you must first pair and connect the *Bluetooth®* Wireless Technology mobile phone.

- The *Bluetooth®* word mark and logos are registered trademarks owned by Bluetooth SIG, Inc. and any use of such marks by Kia is under license. Other trademarks and trade names are those of their respective owners. A *Bluetooth®* enabled cell phone is required to use *Bluetooth®* Wireless Technology

⚠ WARNING

- **Driving while distracted can result in a loss of vehicle control that may lead to an accident, severe personal injury, and death. The driver's primary responsibility is in the safe and legal operation of a vehicle, and use of any handheld devices, other equipment, or vehicle systems which take the driver's eyes, attention and focus away from the safe operation of a vehicle or which are not permissible by law should never be used during operation of the vehicle.**

- *Bluetooth®* Wireless Technology audio can be used only when the [Audio Streaming] of Phone is turned On.

* Setting *Bluetooth®* Wireless Technology Audio Streaming : Press the **SETUP** key ▶ Select [Phone] through the tune knob or **3** key ▶ Select [Audio Streaming] through the TUNE knob ▶ Set On / Off

Starting Bluetooth® Wireless Technology Audio

- Press the **MEDIA** key to change the mode in order of CD → USB → AUX → My Music → BT Audio.
- If BT Audio is selected, *Bluetooth®* Wireless Technology audio will start playing.
- * Audio may not automatically start playing in some mobile phones.

Using the *Bluetooth®* Wireless Technology audio features

• Play / Stop

Press the  TUNE knob to play and pause the current song.



• Previous / Next song



Press  or  to play previous or next song.

* The previous song / next song / play / pause functions may not be supported in some mobile phones.

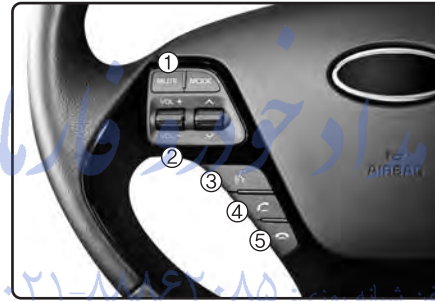

PHONE

Making a call using the Steering-wheel mount controls



- (1) MUTE button : Mute the microphone during a call.
- (2) VOLUME button : Raises or lowers speaker volume.
- (3)  button : Activates voice recognition.
- (4)  button : Places and transfers calls.
- (5)  button : Ends calls or cancels functions.

• Check call history and making call

- ① Shortly press (under 0.8 seconds) the  key on the steering remote controller.
- ② The call history list will be displayed on the screen.
- ③ Press the  key again to connect a call to the selected number.

• Redialing the most recently called number

- ① Press and hold (over 0.8 seconds) the  key on the steering remote controller.
- ② The most recently called number is redialed.

Bluetooth® Wireless Technology

Pairing a Bluetooth® Wireless Technology Device

What is Bluetooth® Wireless Technology Pairing?

Pairing refers to the process of synchronizing your Bluetooth® Wireless Technology phone or device with the car audio system for connection. Pairing is necessary to connect and use the Bluetooth® Wireless Technology feature.

The Bluetooth® word mark and logos are registered trademarks owned by Bluetooth SIG, Inc. and any use of such marks by Kia is under license. Other trademarks and trade names are those of their respective owners. A Bluetooth® enabled cell phone is required to use Bluetooth® wireless technology

⚠ WARNING

- Driving while distracted can result in a loss of vehicle control that may lead to an accident, severe personal injury, and death. The driver's primary responsibility is in the safe and legal operation of a vehicle, and use of any handheld devices, other equipment, or vehicle systems which take the driver's eyes, attention and focus away from the safe operation of a vehicle or which are not permissible by law should never be used during operation of the vehicle.

FarmaSOS.com

Pairing **PHONE** Key / **📶** Key on the Steering Remote Controller

When No Devices have been Paired

1. Press the **PHONE** key or the **📶** key on the steering remote controller. The following screen is displayed.
2. Select [OK] button to enter the Pair Phone screen.

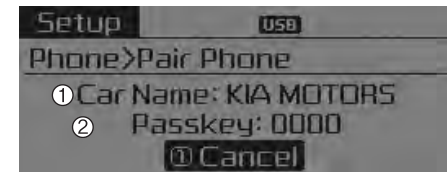

- 1) Car Name : Name of device as shown when searching from your Bluetooth® Wireless Technology device
- 2) Passkey : Passkey used to pair the device

3. From your *Bluetooth*® Wireless Technology device (i.e. Mobile Phone), search and select your car audio system.
4. After a few moments, a screen is displayed where the passkey is entered. Here, enter the passkey "0000" to pair your *Bluetooth*® Wireless Technology device with the car audio system.
5. Once pairing is complete, the following screen is displayed.

Some phones (i.e., iPhone, Android and Blackberry phones) may offer an option to allow acceptance of all future *Bluetooth*® connection requests by default." and "Visit <http://www.kia.com/#/bluetooth> for additional information on pairing your Bluetooth-enabled mobile phone, and to view a phone compatibility list.

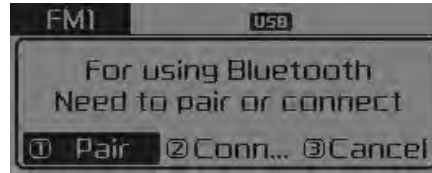

- If *Bluetooth*® Wireless Technology devices are paired but none are currently connected, pressing the **[PHONE]** key or the  key on the steering wheel displays the following screen. Select [Pair] button to pair a new device or select [Connect] to connect a previously paired device.

Pairing through [PHONE] Setup

Press the **[SETUP]** key ▶ Select [Phone] ▶ Select [Pair Phone] ▶ Select  TUNE knob

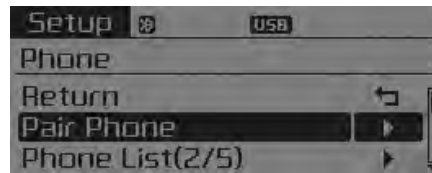

1. The following steps are the same as those described in the section "When No Devices have been Paired" on the previous page.

- *Bluetooth*® Wireless Technology features supported within the vehicle are as follows. Some features may not be supported depending on your *Bluetooth*® Wireless Technology device.
 - Outgoing/Incoming Handsfree calls
 - Operations during a call (Switch to Private, Switch to call waiting, MIC on/off)
 - Downloading Call History
 - Downloading Mobile Contacts
 - *Bluetooth*® Wireless Technology device auto connection
 - Bluetooth Audio Streaming
- Up to five *Bluetooth*® Wireless Technology devices can be paired to the Car Handsfree system.
- Only one *Bluetooth*® Wireless Technology device can be connected at a time.

- Other devices cannot be paired while a *Bluetooth*® Wireless Technology device is connected.
- Only *Bluetooth*® Wireless Technology Handsfree and Bluetooth audio related features are supported.
- Bluetooth related operations are possible only within devices that support Handsfree or audio features, such as a *Bluetooth*® Wireless Technology mobile phone or a Bluetooth audio device.
- If a connected *Bluetooth*® Wireless Technology device becomes disconnected due to being out of communication range, turning the device OFF, or a *Bluetooth*® Wireless Technology communication error, corresponding *Bluetooth*® Wireless Technology devices are automatically searched and reconnected.
- If the system becomes unstable due to communication errors between the car Handsfree and the *Bluetooth*® Wireless Technology device, reset the device by turning off and back on again. Upon resetting *Bluetooth*® Wireless Technology device, the system will be restored.

- After pairing is complete, a contacts download request is sent once to the mobile phone. Some mobile phones may require confirmation upon receiving a download request, ensure your mobile phone accepts the connection. Refer to your phones user's manual for additional information regarding phone pairing and connections.

Connecting a Device

Press the **SETUP** key ▶ Select [Phone] ▶ Select [Phone List]



- 1) Connected Phone : Device that is currently connected

- 2) Paired Phone : Device that is paired but not connected

From the paired phone list, select the device you want to connect and select [Connect].

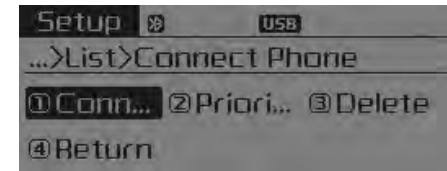

Changing Priority

What is Priority?

It is possible to pair up to five *Bluetooth®* Wireless Technology devices with the car audio system. The "Change Priority" feature is used to set the connection priority of paired phones.

Press the **SETUP** key ▶ Select [Phone] ▶ Select [Phone List]

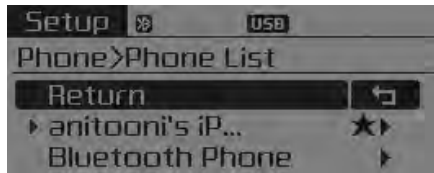

From the paired phone list, select the phone you want to switch to the highest priority, then select [Change Priority] button from the Menu. The selected device will be changed to the highest priority.

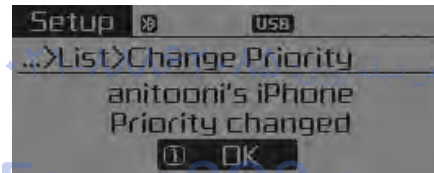
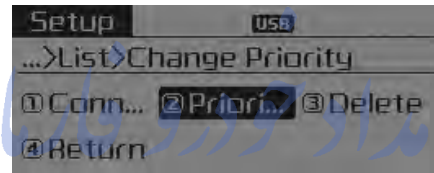

- Priority icon will be displayed when the selected phone is set as a priority phone.

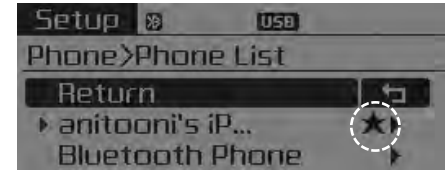

Disconnecting a Device

Press the **SETUP** key ▶ Select [Phone] ▶ Select [Phone List]

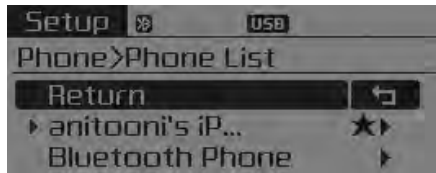

From the paired phone list, select the currently connected device and select [Disconnect] button.

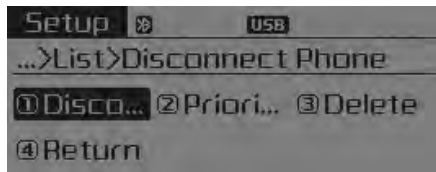

Deleting a Device

Press the **SETUP** key ▶ Select [Phone] ▶ Select [Phone List]



From the paired phone list, select the device you want to delete and select [Delete] button. *تلفن شبانه روزی: ۰۸۵*



- When deleting the currently connected device, the device will automatically be disconnected to proceed with the deleting process.
- If a paired *Bluetooth*® Wireless Technology device is deleted, the device's call history and contacts data will also be deleted.
- To re-use a deleted device, you must pair the device again.

USING *Bluetooth*® Wireless Technology

Phone Menu Screen

Phone Menus

With a *Bluetooth*® Wireless Technology device connected, press the **PHONE** key to display the Phone menu screen.

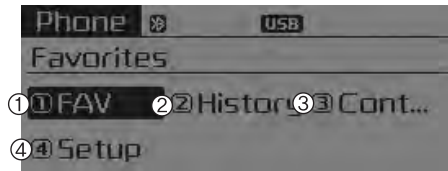

- 1) Favorite : Up to 20 frequently used contacts saved for easy access
- 2) Call History : Displays the call history list screen
- 3) Contacts : Displays the Contacts list screen
- 4) Setup : Displays Phone related settings.

- If you select the [Call History] button but there is no call history data, a prompt is displayed which asks to download call history data.
- If you select the [Contacts] button but there is no contacts data stored, a prompt is displayed which asks to download contacts data.
- This feature may not be supported in some mobile phones. For more information on download support, refer to your mobile phone user's manual.

تلفن شبانه روزی: ۰۲۱-۸۸۶۲۰۸۵

FarmaSOS.com

Answering Calls

Answering a Call

Answering a call with a *Bluetooth*® Wireless Technology device connected will display the following screen.

To accept the call, press  key on the steering wheel while the call is incoming.

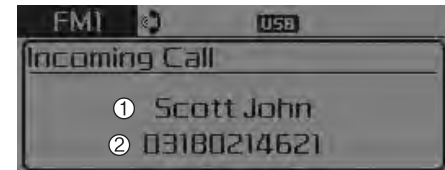

- 1) Caller : Displays the other party's name when the incoming caller is saved within your contacts
- 2) Incoming Number : Displays the incoming number

- When an incoming call pop-up is displayed, most Audio and SETUP mode features are disabled. Only the call volume will operate.
- The telephone number may not be properly displayed in some mobile phones.
- When a call is answered with the mobile phone, the call mode will automatically revert to Private mode.

Favorites

Press the **PHONE** key ▶ Select [Favorites]



- 1) Saved favorite contact : Connects call upon selection
- 2) To add favorite : Downloaded contacts be saved as favorite.

- To save Favorite, contacts should be downloaded.
- Contact saved in Favorites will not be automatically updated if the contact has been updated in the phone. To update Favorites, delete the Favorite and create a new Favorite.

Call History

Press the **PHONE** key ▶ Select [Call History]

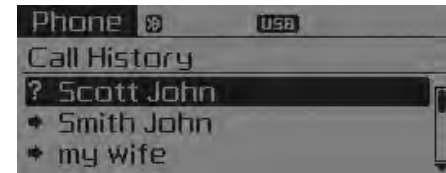

A list of incoming, outgoing and missed calls is displayed.

- Call history may not be saved in the call history list in some mobile phones.
- Calls received with hidden caller ID will not be saved in the call history list.
- Calling through the call history is not possible when there is no call history stored or a *Bluetooth®* Wireless Technology phone is not connected.
- Up to 20 received, dialed and missed calls are stored in Call History.
- Time of received/dialed calls and call time information are not saved.

Contacts

Press the **PHONE** key ▶ Select [Contacts]

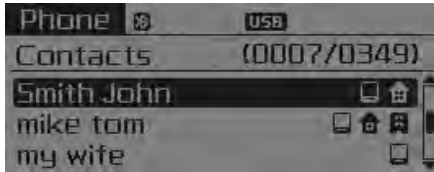

The list of saved phone book entries is displayed.

- Up to 1,000 contacts saved in your *Bluetooth*® Wireless Technology phone can be downloaded into the car contacts. Contacts that have been downloaded to the car cannot be edited or deleted on the phone.
- Mobile phone contacts are managed separately for each paired *Bluetooth*® Wireless Technology device (max 5 devices x 1,000 contacts each). Previously downloaded data is maintained even if the *Bluetooth*® Wireless Technology device has been disconnected. (However, the contacts and call history saved to the phone will be deleted if a paired phone is deleted.)
- It is possible to download contacts during Bluetooth streaming audio.
- When downloading contacts, the icon will be displayed within the status bar.
- It is not possible to begin downloading a contact list when the contact download feature has been turned off within the *Bluetooth*® Wireless Technology device. In addition, some devices may require device authorization upon attempting to download contacts. If downloading does not normally occur, check the *Bluetooth*® Wireless Technology device settings or the screen state.
- The contacts download feature may not be supported in some mobile phones. For more information of supported *Bluetooth*® devices and function support, refer to your phone's user manual.

Bluetooth® Wireless Technology Setting

The *Bluetooth®* word mark and logos are registered trademarks owned by Bluetooth SIG, Inc. and any use of such marks by Kia is under license. Other trademarks and trade names are those of their respective owners. A *Bluetooth®* enabled cell phone is required to use *Bluetooth®* wireless technology

⚠ WARNING

- Driving while distracted can result in a loss of vehicle control that may lead to an accident, severe personal injury, and death. The driver's primary responsibility is in the safe and legal operation of a vehicle, and use of any handheld devices, other equipment, or vehicle systems which take the driver's eyes, attention and focus away from the safe operation of a vehicle or which are not permissible by law should never be used during operation of the vehicle.

Pairing a New Device

Press the **SETUP** key ▶ Select [Phone] ▶ Select [Pair Phone]

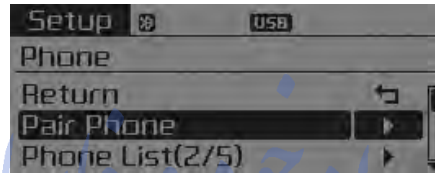

Bluetooth® Wireless Technology devices can be paired with the audio system.

For more information, refer to the "Pairing through Phone Setup" section within *Bluetooth®* Wireless Technology.

Viewing Paired Phone List

Press the **SETUP** key ▶ Select [Phone] ▶ Select [Phone List]

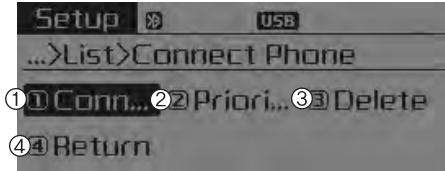
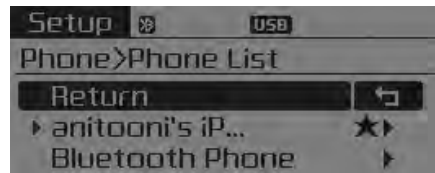

This feature is used to view mobile phones that have been paired with the audio system. Upon selecting a paired phone, the setup menu is displayed.

For more information, refer to the "Setting *Bluetooth®* Wireless Technology Connection" section within *Bluetooth®* Wireless Technology.

- 1) Connect/Disconnect Phone : Connect/ disconnects currently selected phone
- 2) Change Priority : Sets currently selected phone to highest connection priority
- 3) Delete : Deletes the currently selected phone
- 4) Return : Moves to the previous screen

- To learn more about whether your mobile phone supports contacts downloads, refer to your mobile phone user's manual.
- The contacts for only the connected phone can be downloaded

Downloading Contacts

Press the **SETUP** key ▶ Select [Phone] ▶ Select [Contacts Download]

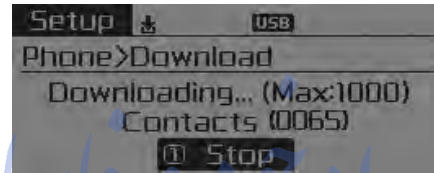

As the contacts are downloaded from the mobile phone, a download progress bar is displayed.

- Upon downloading phone contacts, the previous corresponding data is deleted.
- This feature may not be supported in some mobile phones.
- Voice Recognition may not operate while contacts are being downloaded.

Auto Download (Contacts)

Press the **SETUP** key ▶ Select [Phone] ▶ Select [Auto Download]

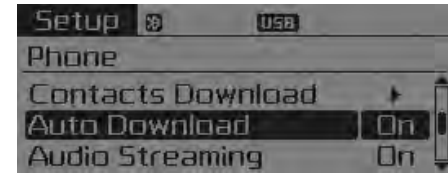

This feature is used to automatically download mobile contacts entries once a *Bluetooth®* Wireless Technology phone is connected.

- The Auto Download feature will download mobile contacts entries every time the phone is connected. The download time may differ depending on the number of saved contacts entries and the communication state.
- Before downloading contacts, first check to see that your mobile phone supports the contacts download feature.

Audio Streaming

Press the **SETUP** key ▶ Select [Phone] ▶ Select [Audio Streaming]

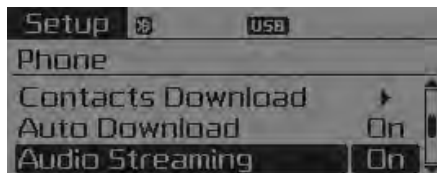

When Audio Streaming is turned on, you can play music files saved in your *Bluetooth*® Wireless Technology device through the audio system.

Outgoing Volume

Press the **SETUP** key ▶ Select [Phone] ▶ Select [Outgoing Volume]

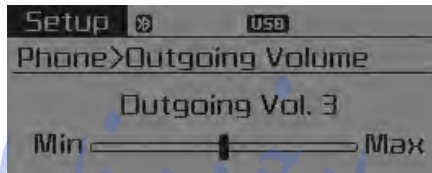

Use **TUNE** knob to adjust the outgoing volume level.

- While on a call, the volume can be changed by using the **SEEK TRACK** key.

Turning Bluetooth System Off

Press the **SETUP** key ▶ Select [Phone] ▶ Select [Bluetooth System Off]

Once *Bluetooth*® Wireless Technology is turned off, *Bluetooth*® Wireless Technology related features will not be supported within the audio system.

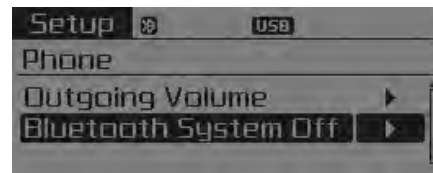

- To turn *Bluetooth*® Wireless Technology back on, go to **SETUP** ▶ [Phone] and select "Yes".

VOICE RECOGNITION

Using Voice Recognition

Starting Voice Recognition

Shortly press the  key on the steering wheel. Say a command.

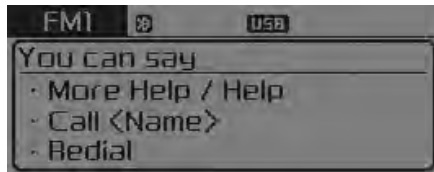

If prompt feedback is in [ON], then the system will say "Please say a command after the beep (BEEP)"

- If prompt feedback is in [OFF] mode, then the system will only say "(BEEP)"
- To change Prompt Feedback [On]/[Off], go to **SETUP** ▶ [System] ▶ [Prompt Feedback]
- For proper recognition, say the command after the voice instruction and beep tone.

Contact List Best Practices

- 1) Do not store single-name entries (e.g., "Bob", "Mom", "Kim", etc.). Instead, always use full names (including first and last names) for all contacts (e.g., use "Jacob Stevenson" instead of "Dad").
- 2) Do not use abbreviations (i.e., use "Lieutenant" instead of "Lt." or "Sergeant" instead of "Sgt.>").
- 3) Do not use acronyms (i.e., use "County Finance Department" instead of "CFD").

- 4) Do not use special characters (e.g., "@", "hyphen -", "asterisk *", ampersand &").
- 5) If a name is not recognized from the contact list, change it to a more descriptive name (e.g., use "Grandpa Joseph" instead of "Pa Joe").

Skipping Prompt Messages

While prompt message is being stated ▶ Shortly press the  key on the steering remote controller.

The prompt message is immediately ended and the beep tone will sound. After the "beep", say the voice command.

Re-starting Voice Recognition

While system waits for a command ▶ Shortly press the  key on the steering remote controller.

The command wait state is immediately ended and the beep tone will sound. After the "beep", say the voice command.

ENDING VOICE RECOGNITION

While Voice Recognition is operating
▶ Press and hold the  key on the steering remote controller

- While using voice command, pressing any steering wheel control or a different key will end voice command.
- When the system is waiting for a voice command, say “cancel” or “end” to end voice command.
- When the system is waiting for a voice command, press and hold the  key on the steering wheel to end voice command.

Voice Recognition and Phone Contact Tips:

The Kia Voice Recognition System may have difficulty understanding some accents or uncommon names. When using Voice Recognition to place a call, speak in a moderate tone, with clear pronunciation To maximize the use of Voice Recognition, consider these guidelines when storing contacts:

- Do not store single-name entries (e.g., “Bob”, “Mom”, etc.). Instead, always use full names (including first and last names) for these contacts
- Do not use special characters (e.g., '@', '-', '*', '&', etc.)
- Do not use abbreviations (i.e., use “Lieutenant” instead of “Lt.”) or acronyms (i.e., use “County Finance Department” instead of “C. F. D.”; Be sure to say the name exactly as it is entered in the contacts list

Illustration on using voice commands

- Starting voice command.

Shortly pressing the  key (under 0.8 seconds):

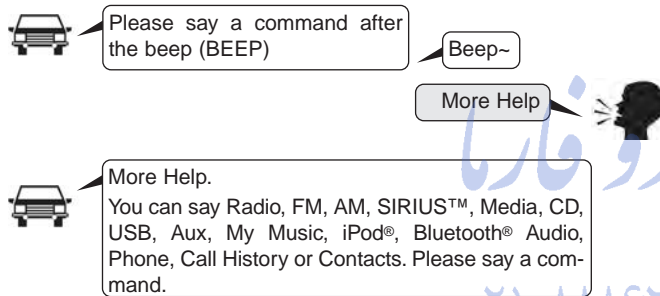

- End voice command.

Shortly pressing the  key (under 0.8 seconds):

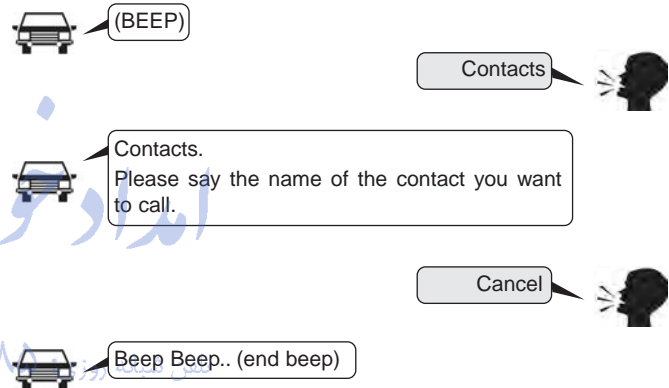

- Skipping Voice Recognition

Shortly pressing the  key (under 0.8 seconds):

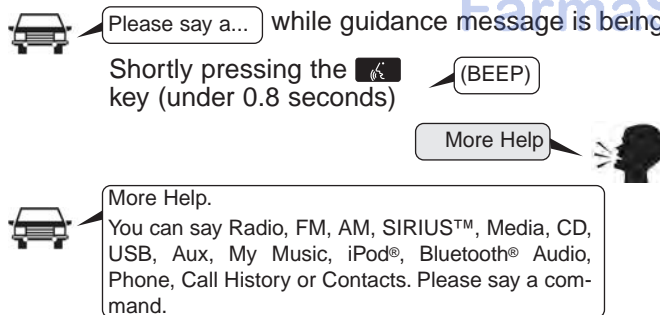

Voice Command List

- **Common Commands:** These commands can be used in most operations. (However a few commands may not be available during certain operations)

Command	Function
More Help	Provides guidance on commands that can be used anywhere in the system.
Help	Provides guidance on commands that can be used within the current mode.
Call<Name>	Calls <Name> saved in Contacts Ex) Call John Smith
Phone	Provides guidance on Phone related commands. After saying this command, say "Favorites", "Call History", "Contacts" or "Dial Number" execute corresponding functions.
Favorites	Display the Favorite screen.
Call History	Displays the Call History screen.
Contacts (Call by Name)	Displays the Contacts screen. After saying this command, say the name of a contact saved in the Contacts to automatically connect the call.
Dial Number	Display the Dial number screen. After saying this command, you can say the number that you want to call.
Redial	Connects the most recently called number.

Command	Function
Radio	<ul style="list-style-type: none"> • When listening to the radio, displays the next radio screen. (FM1→FM2→AM→SAT1→SAT2→SAT3→FM1) • When listening to a different mode, displays the most recently played radio screen. • When currently listening to the FM radio, maintains the current state. • When listening to a different mode, displays the most recently played FM screen.
FM1(FM One)	Displays the FM1 screen.
FM2(FM Two)	Displays the FM2 screen.
AM	Displays the AM screen.
FM Preset 1~6	Plays the most recently played broadcast saved in FM Preset 1~6.
AM Preset 1~6	Plays the broadcast saved in AM Preset 1~6.
FM 87.5~107.9	Plays the FM broadcast of the corresponding frequency.
AM 530~1710	Plays the AM broadcast of the corresponding frequency.
SIRIUS™ (Satellite)	<ul style="list-style-type: none"> • When currently listening to the SIRIUS™, maintains the current state. • When listening to a different mode, displays the most recently played SIRIUS™ screen.

Command	Function
SIRIUS™ (Satellite) 1-3	Displays the selected SIRIUS™ screen.
SIRIUS™ Channel 0-223	Plays the selected SIRIUS™ channel.
Media	Moves to the most recently played media screen.
CD	Plays the music saved in the CD.
USB	Plays USB music.
iPod®	Plays iPod music.

Command	Function
My Music	Plays the music saved in My Music.
AUX (Auxiliary)	Plays the connected external device.
Bluetooth® Audio	Plays the music saved in connected Bluetooth® device.
Please repeat	Repeats the most recent comment.
Cancel (Exit)	Ends voice command.

تلفن شبانه روزی: ۰۲۱-۸۸۸۶۲۰۸۵

FarmaSOS.com

Features of your vehicle

- FM/AM radio commands: Commands available during FM, AM radio operation

Command	Function
Preset 1~6	Plays the broadcast station saved in Preset 1~6.
Auto Store	Automatically selects radio broadcast frequencies with superior reception and saves in Presets 1~6.
Seek up	Plays the next (higher) receivable broadcast.
Seek down	Plays the previous (lower) receivable broadcast.
Scan	Scans receivable frequencies from the current broadcast and plays for 10 seconds each.
Preset Scan	Moves to the next preset from the current present and plays for 10 seconds each.
Information	Displays the information of the current broadcast. (This feature can be used when receiving RBDS broadcasts.)

- Satellite radio commands: Commands that can be used while listening to Satellite Radio.

Command	Function
Scan	Scans receivable channels from the current broadcast and plays for 10 seconds each.
Preset 1~6	Plays the broadcast saved in Preset 1~6.
Information	Displays the information of the current broadcast.

FarmaSOS.com

- Audio CD commands: Commands available during Audio CD operation

Command	Function
Random	Randomly plays the tracks within the CD.
Random Off	Cancels random play to play tracks in sequential order.
Repeat	Repeats the current track.
Repeat Off	Cancels repeat play to play tracks in sequential order.
Scan	Scans the tracks from the next track for 10 seconds each.
Track 1~30	Plays the desired track number.
Information	Displays the information screen of the current track.

- MP3 CD / USB commands: Commands available during USB and MP3 CD operation

Command	Function
Random	Randomly plays the files within the current folder.
All Random	Randomly plays all saved files.
Random Off	Cancels random play to play files in sequential order.
Repeat	Repeats the current file.
Folder Repeat	Repeats all files in the current folder.
Repeat Off	Cancels repeat play to play files in sequential order.
Next File	Plays the next file.
Previous File	Plays the previous file.
Scan	Scans the files from the next files for 10 seconds each.
Information	Displays the information screen of the current file.
Copy	Copies the current file into My Music.

FarmaSOS.com

Features of your vehicle

- iPod® Commands: Commands available during iPod® operation

Command	Function
Random	Randomly plays the songs within the current category.
Random Off	Cancels random play to play songs in sequential order.
Repeat	Repeats the current song.
Repeat Off	Cancels repeat play to play songs in sequential order.
Information	Displays the information screen of the current song.

- My Music Commands: Commands available during My Music operation

Command	Function
Random	Randomly plays all saved files.
Random Off	Cancels random play to play files in sequential order.
Repeat	Repeats the current file.
Repeat Off	Cancels repeat play to play files in sequential order.
Scan	Scans the files from the next files for 10 seconds each.
Information	Displays the information screen of the current file.
Delete	Deletes the current file. You will bypass an additional confirmation process.
Delete All	Deletes all files saved in My Music. You will bypass an additional confirmation process.

۰۲۱-۸۸۶۲۰۸۵

FarmaSOS.com

- **Bluetooth® Wireless Technology Audio Commands:** Commands available during *Bluetooth®* Wireless Technology audio streaming from mobile phone operation Command Operation

Command	Function
Play	Plays the currently paused song.
Pause	Pauses the current song.

iPod® is a registered trademark of Apple Inc. iPod® mobile digital device sold separately.

The Bluetooth® word mark and logos are registered trademarks owned by Bluetooth SIG, Inc. and any use of such marks by Kia is under license.

A Bluetooth® enabled cell phone is required to use Bluetooth® wireless technology.

SiriusXM™ service requires a subscription, sold separately, after 3-month trial included with vehicle purchase. If you decide to continue your

SiriusXM™ service at the end of the trial subscription, the plan you choose will automatically renew and bill at the current rates until you call

SiriusXM™ at 1-866-635-2349 to cancel. See our Customer Agreement for complete terms at www.siriusxm.com. Sirius satellite service is available

only to those at least 18 and older in the 48 contiguous United States, D.C., and P.R. (with coverage limitations). SiriusXM™ Traffic available in

select markets. See siriusxm.com/traffic for more information. Sirius, XM and all related marks and logos are trademarks of Sirius XM Radio Inc.

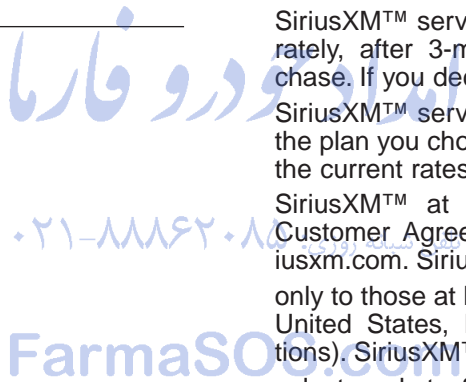

Driving your vehicle

Before driving	5-3	Special driving conditions	5-43
Key positions	5-5	• Hazardous driving conditions	5-43
Engine start/stop button	5-7	• Rocking the vehicle	5-43
• Illuminated ENGINE START/STOP button	5-7	• Smooth cornering	5-44
• ENGINE START/STOP button position.	5-7	• Driving at night	5-44
Starting the engine	5-10	• Driving in the rain.	5-45
Manual transaxle	5-13	• Driving in flooded areas	5-45
• Manual transaxle operation	5-13	• Driving off-road.	5-46
Automatic transaxle	5-16	• Highway driving	5-46
• Automatic transaxle operation.	5-16	Winter driving	5-47
Brake system	5-22	Trailer towing	5-49
• Power brakes	5-22	Vehicle load limit	5-50
• Parking brake	5-23	• Tire and loading information label	5-50
• Anti-lock brake system (ABS)	5-25	• Certification label	5-53
• Electronic stability control (ESC)	5-27	Vehicle weight	5-55
• Hill-start assist control (HAC)	5-31	• Base curb weight	5-55
• Vehicle stability management (VSM)	5-31	• Vehicle curb weight	5-55
Cruise control system.	5-35	• Cargo weight	5-55
Active eco system	5-40	• GAW (Gross axle weight)	5-55
Economical operation	5-41	• GAWR (Gross axle weight rating)	5-55
		• GVW (Gross vehicle weight)	5-55
		• GVWR (Gross vehicle weight rating)	5-55

Be sure the exhaust system does not leak.

The exhaust system should be checked whenever the vehicle is raised to change the oil or for any other purpose. If you

hear a change in the sound of the exhaust or if you drive over something that strikes the underneath side of the vehicle, have the exhaust system checked as soon as possible by an authorized Kia dealer.

⚠ WARNING - Engine exhaust

Do not inhale exhaust fumes or leave your engine running in an enclosed area for a prolonged time.

Exhaust fumes contain carbon monoxide, a colorless, odorless gas that can cause unconsciousness and death by asphyxiation.

⚠ WARNING - Open trunk

Do not drive with the trunk open.

Poisonous exhaust gases can enter the passenger compartment. If you must drive with the trunk open proceed as follows:

1. Close all windows.
2. Open side vents.
3. Set the air intake control at "Fresh", the air flow control at "Floor" or "Face" and the fan at the highest speed.

FarmaSOS.com

BEFORE DRIVING

Before entering vehicle

- Be sure that all windows, outside mirror(s), and outside lights are clean.
- Check the condition of the tires.
- Check under the vehicle for any sign of leaks.
- Be sure there are no obstacles behind you if you intend to back up.

Necessary inspections

Fluid levels, such as engine oil, engine coolant, brake fluid, and washer fluid should be checked on a regular basis, with the exact interval depending on the fluid. Further details are provided in Chapter 7, "Maintenance".

WARNING - Distracted driving

Focus on the road while driving. The driver's primary responsibility is in the safe and legal operation of the vehicle. Use of any hand held devices, other equipment or vehicle systems that distract the driver should not be used during vehicle operation.

تلفن شبانه روزی: ۰۲۱-۸۸۸۶۲۰۸۵

FarmaSOS.com

Before starting

- Close and lock all doors.
- Position the seat so that all controls are easily reached.
- Buckle your seat belt.
- Adjust the inside and outside rearview mirrors.
- Be sure that all lights work.
- Check all gauges.
- Check the operation of warning lights when the ignition switch is turned to the ON position.
- Release the parking brake and make sure the brake warning light goes off.

For safe operation, be sure you are familiar with your vehicle and its equipment.

WARNING - Check surrounding

Always check the surrounding areas near your vehicle for people, especially children, before putting a vehicle into D (Drive) or R (Reverse).

⚠ WARNING - Driving while intoxicated

Do not drive while intoxicated. Drinking and driving is dangerous. Even a small amount of alcohol will affect your reflexes, perceptions and judgment. Driving while under the influence of drugs is as dangerous as or more dangerous than driving drunk.

⚠ WARNING - Loose object

Securely store items in your vehicle. When you make a sudden stop or turn the steering wheel rapidly, loose objects may drop on the floor and it could interfere with the operation of the foot pedals, possibly causing an accident.

⚠ WARNING - Fire risk

When you intend to park or stop the vehicle with the engine on, be careful not to depress the accelerator pedal for a long period of time. It may overheat the engine or exhaust system and cause a fire.

تلفن شبانه روزی: ۰۲۱-۸۸۸۶۲۰۸۵

FarmaSOS.com

KEY POSITIONS

Illuminated ignition switch (if equipped)



Whenever a front door is opened, the ignition switch will illuminate for your convenience, provided the ignition switch is not in the ON position. The light will go off immediately when the ignition switch is turned on. It will also go off after about 30 seconds after the door is closed.

Ignition switch position

LOCK

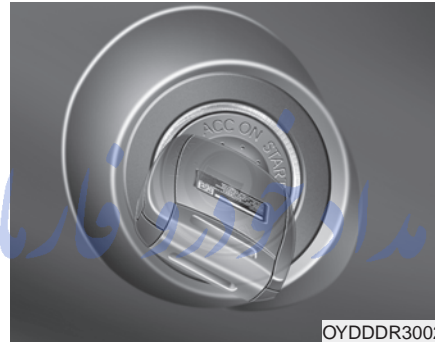

The steering wheel locks to protect against theft. The ignition key can be removed only in the LOCK position. When turning the ignition switch to the LOCK position, push the key inward at the ACC position and turn the key toward the LOCK position.

The anti-theft steering column lock is not a substitute for the parking brake. Before leaving the driver's seat, always make sure the shift lever is engaged in 1st gear for the manual transaxle or P (Park) for the automatic transaxle, set the parking brake fully and shut the engine off.

ACC (Accessory)

The steering wheel is unlocked and electrical accessories are operative.

If difficulty is experienced turning the ignition switch to the ACC position, turn the key while turning the steering wheel right and left to release the tension.

ON

The warning lights can be checked before the engine is started. This is the normal running position after the engine is started.

Do not leave the ignition switch ON if the engine is not running to prevent battery discharge.

START

Turn the ignition switch to the START position to start the engine. The engine will crank until you release the key; then it returns to the ON position. The brake warning light can be checked in this position.

امداد خودرو فارما

تلفن شبانه روزی: ۰۲۱-۸۸۸۶۲۰۸۵

FarmaSOS.com

⚠ WARNING - Ignition switch

Never turn the ignition switch to LOCK or ACC while the vehicle is moving. This would result in loss of directional control and braking function, which could cause an accident.

⚠ WARNING - Steering wheel

Never reach for any controls through the steering wheel while the vehicle is in motion. The presence of your hand or arm in this area could cause a loss of vehicle control.

ENGINE START/STOP BUTTON (IF EQUIPPED)

Illuminated ENGINE START/STOP button



OYDDDR3005

Whenever the front door is opened, the ENGINE START/STOP button will illuminate for your convenience. The light will go off after about 30 seconds after the door is closed.

ENGINE START/STOP button position

OFF



White

To turn off the engine (START/STOP position) or vehicle power (ON position), press the ENGINE START/STOP button with the shift lever in the P (Park) position. When you press the ENGINE START/STOP button without the shift lever in the P (Park) position, the ENGINE START/STOP button will not change to the OFF position but to the ACC position.

In an emergency situation while the vehicle is in motion, you are able to turn the engine off and to the ACC position by pressing the ENGINE START/STOP button for more than 2 seconds or 3 times successively within 3 seconds. If the vehicle is still moving, you can restart the engine without depressing the brake pedal by pressing the ENGINE START/STOP button with the shift lever in the N (Neutral) position (if smart key equipped).

ACC(Accessory)



Orange

Press the ENGINE START/STOP button while it is in the OFF position without depressing the brake pedal.

The steering wheel unlocks and electrical accessories are operational.

If the ENGINE START/STOP button is in the ACC position for more than 1 hour, the button is turned off automatically to prevent battery discharge.

ON



Red

Press the ENGINE START/STOP button while it is in the ACC position without depressing the brake pedal.

The warning lights can be checked before the engine is started. Do not leave the ENGINE START/STOP button in the ON position for a long time. The battery may discharge, because the engine is not running.

START/RUN



Not illuminated

To start the engine, depress the brake pedal and press the ENGINE START/STOP button with the shift lever in the P (Park) or the N (Neutral) position. For your safety, start the engine with the shift lever in the P (Park) position.

If you press the ENGINE START/STOP button without depressing the brake pedal, the engine will not start and the button will change as follows:

OFF → ACC → ON → OFF

FarmaSOS.com

If you leave the ENGINE START/STOP button in the ACC or ON position for a long time, the battery will discharge.

⚠ WARNING - Starting vehicle

Never press the ENGINE START/STOP button while the vehicle is in motion. This would result in loss of directional control and braking function, which could cause an accident.

امداد خودرو فارما

تلفن شبانه روزی: ۰۲۱-۸۸۸۶۲۰۸۵

FarmaSOS.com

STARTING THE ENGINE

WARNING - Proper footwear

Always wear appropriate shoes when operating your vehicle. Unsuitable shoes (high heels, ski boots, sandals, etc.) may interfere with your ability to use the brake and accelerator pedals.

Starting the engine with an ignition key (if equipped)

1. Make sure the parking brake is applied.
2. **Manual Transaxle** - Depress the clutch pedal fully and shift the transaxle into Neutral. Keep the clutch pedal and brake pedal depressed while turning the ignition switch to the start position.

Automatic Transaxle - Place the transaxle shift lever in P (Park). Depress the brake pedal fully.

You can also start the engine when the shift lever is in the N (Neutral) position.

3. Turn the ignition switch to START and hold it there until the engine starts (a maximum of 10 seconds), then release the key.
4. In extremely cold weather (below 0°F / -18°C) or after the vehicle has not been operated for several days, let the engine warm up without depressing the accelerator.

*Whether the engine is cold or warm, it should be started **without depressing the accelerator.***

If the engine stalls while the vehicle is in motion, do not attempt to move the shift lever to the P (Park) position. If traffic and road conditions permit, you may put the shift lever in the N (Neutral) position while the vehicle is still moving and turn the ignition switch to the START position in an attempt to restart the engine.

CAUTION - Starter

Do not engage the starter for more than 10 seconds. If the engine stalls or fails to start, wait 5 to 10 seconds before re-engaging the starter. Improper use of the starter may damage it.

Starting the engine with a smart key (if equipped)

1. Carry the smart key or leave it inside the vehicle.
2. Make sure the parking brake is firmly applied
3. Place the transaxle shift lever in P (Park).
4. Press the ENGINE START/STOP button while depressing the brake pedal.
5. In extremely cold weather (below 0°F / -18°C) or after the vehicle has not been operated for several days, let the engine warm up without depressing the accelerator.

Whether the engine is cold or warm, it should be started without depressing the accelerator.

- Even if the smart key is in the vehicle, but is far away from you, the engine may not start.
- When the ENGINE START/STOP button is in the ACC position or above, if any door is opened, the system checks for the smart key. If the smart key is not in the vehicle, the "KEY OUT" or "🚗" indicator will blink or the warning "Key not in vehicle" will illuminate on the LCD display. And if all doors are closed, the chime will sound for 5 seconds. The indicator or warning will turn off while the vehicle is moving. Always have the smart key with you.

The engine will start only when the smart key is in the vehicle.

WARNING - Unintended vehicle movement

Never leave the smart key in the vehicle with children or vehicle occupants who are unfamiliar with the vehicle operation. Pushing the ENGINE START/STOP button while the smart key is in the vehicle may result in unintended engine activation and/or unintended vehicle movement.



Do not press the ENGINE START/STOP button for more than 10 seconds except when the stop lamp fuse is blown.

امداد خودرو فارما

- If the battery is weak or the smart key does not work correctly, you can start the engine by pressing the engine start/stop button with the smart key.
- When the stop lamp fuse is blown, you can not start the engine normally. Replace the fuse with a new one. If it is not possible, you can start the engine by pressing the ENGINE START/STOP button for 10 seconds while it is in the ACC position. The engine can start without depressing the brake pedal. But for your safety always depress the brake pedal before starting the engine.

تلفن شبانه روزی: ۰۲۱-۸۸۸۶۲۰۸۵

FarmaSOS.com

MANUAL TRANSAXLE (IF EQUIPPED)

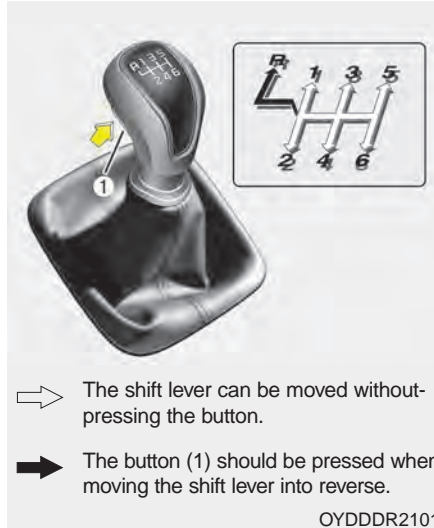

Manual transaxle operation

The manual transaxle has 6 forward gears.

This shift pattern is imprinted on the shift knob. The transaxle is fully synchronized in all forward gears so shifting to either a higher or a lower gear is easily accomplished.

Depress the clutch pedal down fully while shifting, then release it slowly.

If your vehicle is equipped with an ignition lock switch, the engine will not start when starting the engine without depressing the clutch pedal.

The shift lever must be returned to the neutral position before shifting into R (Reverse). The button (1) located below the shift knob must be pulled upward while moving the shift lever to the R (Reverse) position.

Make sure the vehicle is completely stopped before shifting into R (Reverse).

Never operate the engine with the tachometer (rpm) in the red zone.

⚠ CAUTION - Downshifting
Do not downshift more than 2 gears or downshift the gear when the engine is running at high speed (5,000 RPM or higher). Such downshifting may damage the engine.

- During cold weather, shifting may be difficult until the transaxle lubricant is warmed up. This is normal and not harmful to the transaxle.
- If you've come to a complete stop and it's hard to shift into 1st or R (Reverse), leave the shift lever at neutral position and release the clutch. Depress the clutch pedal and then shift into 1st or R (Reverse) gear position.

 **CAUTION - Premature wear**

Do not use the shift lever as a handrest during driving, as this can result in premature wear of the transaxle shift forks.

 **WARNING - Incline parking**

Before leaving the driver's seat, always set the parking brake fully and shut the engine off. Then make sure the transaxle is shifted into 1st gear when the vehicle is parked on a level or uphill grade, and shifted into R (Reverse) on a downhill grade. Unexpected and sudden vehicle movement can occur if these precautions are not followed in the order identified.

Using the clutch

The clutch should be depressed all the way to the floor before shifting, then released slowly. The clutch pedal should always be fully released while driving. Do not rest your foot on the clutch pedal while driving. This can cause unnecessary wear. Do not partially engage the clutch to hold the vehicle on an incline. This causes unnecessary wear. Use the foot brake or parking brake to hold the vehicle on an incline. Do not operate the clutch pedal rapidly and repeatedly.

Downshifting

When you must slow down in heavy traffic or while driving up steep hills, downshift before the engine starts to labor. Downshifting reduces the chance of stalling and gives better acceleration when you need to increase your speed again. When the vehicle is traveling down steep hills, downshifting helps maintain safe speed and prolongs brake life.

تلفن شبانه روزی: ۰۸۵-۲۰۶۲۰۸۸۶-۲۱
FarmaSOS.com

Good driving practices

- Never take the vehicle out of gear and coast down a hill. This is extremely hazardous. Always leave the vehicle in gear.
- Don't "ride" the brakes. This can cause them to overheat and malfunction. Instead, when you are driving down a long hill, shift to a lower gear. When you do this, engine braking will help slow down the vehicle.
- Slow down before shifting to a lower gear. This will help avoid over-revving the engine, which can cause damage.
- Slow down when you encounter cross winds. This gives you much better control of your vehicle.
- Be sure the vehicle is completely stopped before you attempt to shift into R (Reverse). The transaxle can be damaged if you do not.
- Exercise extreme caution when driving on a slippery surface. Be especially careful when braking, accelerating or shifting gears. On a slippery surface, an abrupt change in vehicle speed can cause the drive wheels to lose traction and the vehicle to go out of control.
- Always buckle-up! In a collision, an unbelted occupant is significantly more likely to be seriously injured or killed than a properly belted occupant.
- Never exceed posted speed limits.



AUTOMATIC TRANSAXLE (IF EQUIPPED)

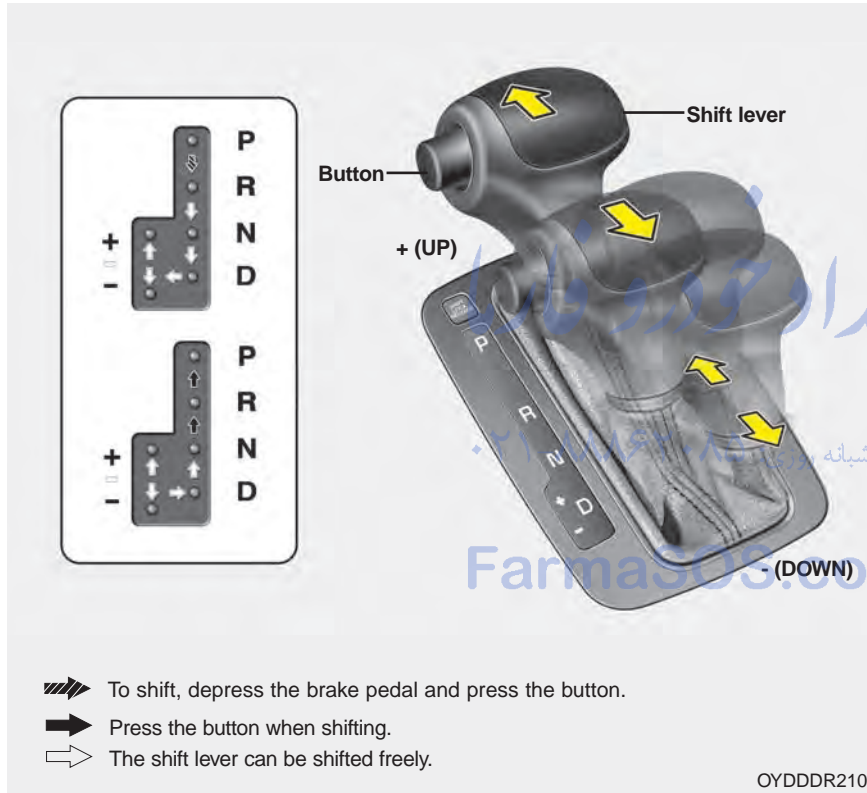

Automatic transaxle operation

The automatic transaxle has 6 forward speeds and one reverse speed. The individual speeds are selected automatically, depending on the position of the shift lever.

* NOTICE

The first few shifts on a new vehicle, if the battery has been disconnected, may be somewhat abrupt. This is a normal condition, and the shifting sequence will adjust after shifts are cycled a few times by the TCM (Transaxle Control Module) or PCM (Powertrain Control Module).

For smooth operation, depress the brake pedal when shifting from N (Neutral) to a forward or reverse gear.

 **CAUTION - Transaxle**

To avoid damage to your transaxle, do not accelerate the engine in R (Reverse) or any forward gear position with the brakes on. The transaxle may be damaged if you shift into P (Park) while the vehicle is in motion.

When stopped on an upgrade, do not hold the vehicle with engine power. Use the service brake or the parking brake.

تلفن شبانه روزی: ۰۲۱-۸۸۸۶۲۰۸۵

FarmaSOS.com

Transaxle ranges

The indicator light in the instrument cluster displays the shift lever position when the ignition switch is in the ON position.

P (Park)

Always come to a complete stop before shifting into P (Park). This position locks the transaxle and prevents the front wheels from rotating.

Shifting into P (Park) while the vehicle is in motion will cause the drive wheels to lock which will cause you to lose control of the vehicle.

R (Reverse)

Use this position to drive the vehicle backward.

⚠ CAUTION - Shifting

Always come to a complete stop before shifting into or out of R (Reverse); you may damage the transaxle if you shift into R (Reverse) while the vehicle is in motion, except when "Rocking the Vehicle" explained in this section.

N (Neutral)

The wheels and transaxle are not engaged. The vehicle will roll freely even on the slightest incline unless the parking brake or service brakes are applied.

D (Drive)

This is the normal forward driving position. The transaxle will automatically shift through a 6-gear sequence, providing the best fuel economy and power.

For extra power when passing another vehicle or climbing grades, depress the accelerator fully, at which time the transaxle will automatically downshift to the next lower gear.

تلفن شبانه روزی: ۰۲۱-۸۸۸۶۲۰۸۵

FarmaSOS.com

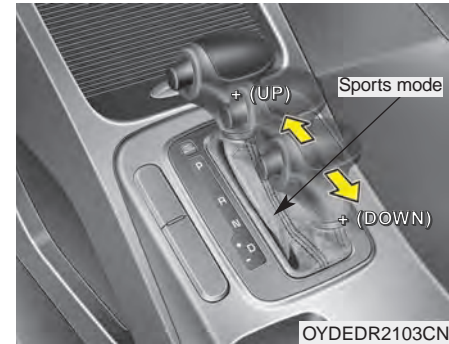

Sports mode

Whether the vehicle is stopped or in motion, sports mode is selected by pushing the shift lever from the D (Drive) position into the manual gate. To return to D (Drive) range operation, push the shift lever back into the main gate.

In sports mode, moving the shift lever backwards and forwards will allow you to make gearshifts rapidly. In contrast to a manual transaxle, the sports mode allows gearshifts with the accelerator pedal depressed.

Up (+) : Push the lever forward once to shift up one gear.

Down (-) : Pull the lever backwards once to shift down one gear.

- In sports mode, the driver must execute upshifts in accordance with road conditions, taking care to keep the engine speed below the red zone.
- In sports mode, only the 6 forward gears can be selected. To reverse or park the vehicle, move the shift lever to the R (Reverse) or P (Park) position as required.
- In sports mode, downshifts are made automatically when the vehicle slows down. When the vehicle stops, 1st gear is automatically selected.
- In sports mode, when the engine rpm approaches the red zone shift points are varied to upshift automatically.

- To maintain the required levels of vehicle performance and safety, the system may not execute certain gearshifts when the shift lever is operated.
- When driving on a slippery road, push the shift lever forward into the +(up) position. This causes the transaxle to shift into the 2nd gear which is better for smooth driving on a slippery road. Push the shift lever to the -(down) side to shift back to the 1st gear.

تلفن شبانه روزی: ۰۲۱-۸۸۶۲۰۸۵

FarmaSOS.com

Paddle shifter (if equipped)

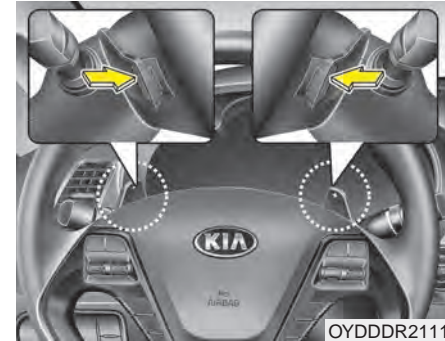

The paddle shifter is available when the shift lever is in the D position or the sport mode.

With the shift lever in the D position

The paddle shifter can operate when the vehicle speed is more than 6.2 mph.

Pull the [+] or [-] paddle shifter once to shift up or down one gear and the system changes from automatic mode to manual mode.

If the vehicle speed is lower than 6.2 mph, if you depress the accelerator pedal for more than 7 seconds or if you shift the shift lever from D to sports mode and shift it from sports mode to D again, the system change from manual mode to automatic mode.

With the shift lever in the sports mode

Pull the [+] or [-] paddle shifter once to shift up or down one gear.

If you pull the [+] and [-] paddle shifters at the same time, you can't shift the gear.

Shift lock system (if equipped)

For your safety, the automatic transaxle has a shift lock system which prevents shifting the transaxle out of P (Park) unless the brake pedal is depressed.

To shift the transaxle from P (Park) into R (Reverse):

1. Depress and hold the brake pedal.
2. Start the engine or turn the ignition switch to the ON position.
3. Move the shift lever.

If the brake pedal is repeatedly depressed and released with the shift lever in the P (Park) position, a chattering noise near the shift lever may be heard. This is a normal condition.

⚠ WARNING - Shifting from park

Always fully depress the brake pedal before and while shifting out of the P (Park) position into another position to avoid inadvertent motion of the vehicle.

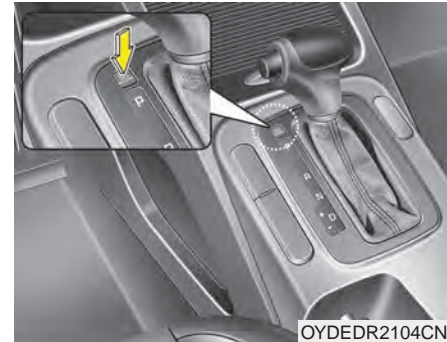

Shift-lock override (with smart key system)

If the shift lever cannot be moved from the P (Park) position into the R (Reverse) position with the brake pedal depressed, continue depressing the brake, then do the following:

1. Carefully remove the cap covering the shift-lock access hole (1).
2. Insert a key (or screwdriver) into the access hole and press down on the key (or screwdriver).
3. Move the shift lever.
4. Have your vehicle inspected by an authorized Kia dealer immediately.

***Ignition key interlock system
(if equipped)***

The ignition key cannot be removed unless the shift lever is in the P (Park) position.

Good driving practices

- Never move the shift lever from P (Park) or N (Neutral) to any other position with the accelerator pedal depressed.
- Never move the shift lever into P (Park) when the vehicle is in motion.
- Slow down before shifting to a lower gear. Otherwise, the lower gear may not be engaged.
- Always use the parking brake. Do not depend on placing the transaxle in P (Park) to keep the vehicle from moving.
- Optimum vehicle performance and economy is obtained by smoothly depressing and releasing the accelerator pedal.

Moving up a steep grade from a standing start

To move up a steep grade from a standing start, depress the brake pedal, shift the shift lever to D (Drive). Select the appropriate gear depending on load weight and steepness of the grade, and release the parking brake. Depress the accelerator gradually while releasing the service brakes.

تلفن شبانه روزی: ۰۲۱-۸۸۸۶۲۰۸۵

FarmaSOS.com

BRAKE SYSTEM

Power brakes

Your vehicle has power-assisted brakes that adjust automatically through normal usage.

In the event that the power-assisted brakes lose power because of a stalled engine or some other reason, you can still stop your vehicle by applying greater force to the brake pedal than you normally would. The stopping distance, however, will be longer.

When the engine is not running, the reserve brake power is partially depleted each time the brake pedal is applied. Do not pump the brake pedal when the power assist has been interrupted.

Pump the brake pedal only when necessary to maintain steering control on slippery surfaces.



CAUTION - Brake pedal

Do not drive with your foot resting on the brake pedal. This will create abnormally high brake temperatures which can cause excessive brake lining and pad wear.



WARNING - Steep hill braking

Avoid continuous application of the brakes when descending a long or steep hill by shifting to a lower gear. Continuous brake application will cause the brakes to overheat and could result in a temporary loss of braking performance.

Wet brakes may impair the vehicle's ability to safely slow down; the vehicle may also pull to one side when the brakes are applied. Applying the brakes lightly will indicate whether they have been affected in this way.

To dry the brakes, apply them lightly while maintaining a safe forward speed until brake performance returns to normal.

In the event of brake failure

If service brakes fail to operate while the vehicle is in motion, you can make an emergency stop with the parking brake. The stopping distance, however, will be much greater than normal.



WARNING - Parking brake

Avoid applying the parking brake to stop the vehicle while it is moving except in an emergency situation. Applying the parking brake while the vehicle is moving at normal speeds can cause a sudden loss of control of the vehicle. If you must use the parking brake to stop the vehicle, use great caution in applying the brake.

Disc brakes wear indicator

When your brake pads are worn and new pads are required, you will hear a high-pitched warning sound from your front brakes or rear brakes (if equipped). You may hear this sound come and go or it may occur whenever you depress the brake pedal.

Please remember that some driving conditions or climates may cause a brake squeal when you first apply (or lightly apply) the brakes. This is normal and does not indicate a problem with your brakes.

⚠ CAUTION - Replace brake pads

Do not continue to drive with worn brake pads. Continuing to drive with worn brake pads can damage the braking system and result in costly brake repairs.

Always replace the front or rear brake pads as pairs.

⚠ WARNING - Brake wear
Do not ignore high pitched wear sounds from your brakes. If you ignore this audible warning, you will eventually lose braking performance, which could lead to a serious accident.

امداد خودرو فارما

تلفن شبانه روزی: ۰۲۱-۸۸۸۶۲۰۸۵

FarmaSOS.com

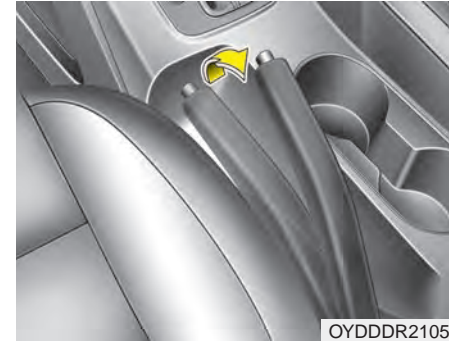
Parking brake**Applying the parking brake**

OYDDDR2105

To engage the parking brake, first apply the foot brake and then without pressing the release button in, pull the parking brake lever up as far as possible. In addition it is recommended that when parking the vehicle on a gradient, the shift lever should be positioned in the appropriate low gear for manual transaxle vehicles or in the P (Park) position for automatic transaxle vehicles.

⚠ CAUTION - Parking brake

Driving with the parking brake applied will cause excessive brake pad (or lining) and brake rotor wear.

Releasing the parking brake

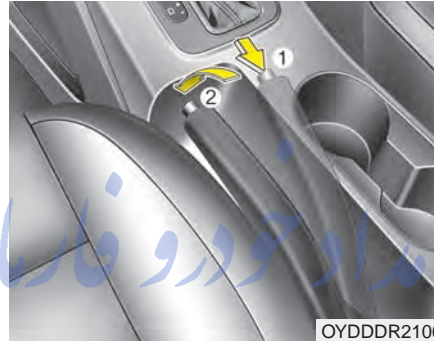

To release the parking brake, first apply the foot brake and pull up the parking brake lever slightly. Secondly, press the release button (1) and lower the parking brake lever (2) while holding the button.

⚠ WARNING - Parking brake use

All vehicles should always have the parking brake fully engaged when parking to avoid inadvertent movement of the vehicle which can injure occupants or pedestrians.



W-75

Check the brake warning light by turning the ignition switch ON (do not start the engine). This light will illuminate when the parking brake is applied with the ignition switch in the START or ON position.

Before driving, be sure the parking brake is fully released and the brake warning light is off.

If the brake warning light remains on after the parking brake is released while the engine is running, there may be a malfunction in the brake system. Immediate attention is necessary.

If at all possible, stop driving the vehicle immediately. If that is not possible, use extreme caution while operating the vehicle and only continue to drive the vehicle until you can reach a safe location or repair shop.

امداد خودرو فارما

تلفن شبانه روزی: ۰۲۱-۸۸۸۶۲۰۸۵

FarmaSOS.com

Anti-lock brake system (ABS)

ABS (or ESC) will not prevent accidents due to improper or dangerous driving maneuvers. Even though vehicle control is improved during emergency braking, always maintain a safe distance between you and objects ahead. Vehicle speeds should always be reduced during extreme road conditions.

The vehicle should be driven at reduced speeds in the following circumstances:

- When driving on rough, gravel or snow-covered roads
- When driving on roads where the road surface is pitted or has different surface heights.

Driving in these conditions increases the stopping distance for your vehicle.

The ABS continuously senses the speed of the wheels. If the wheels are going to lock, the ABS system repeatedly modulates the hydraulic brake pressure to the wheels.

When you apply your brakes under conditions which may lock the wheels, you may hear a “tik-tik” sound from the brakes, or feel a corresponding sensation in the brake pedal. This is normal and it means your ABS is active.

In order to obtain the maximum benefit from your ABS in an emergency situation, do not attempt to modulate your brake pressure and do not try to pump your brakes. Press your brake pedal as hard as possible or as hard as the situation allows the ABS to control the force being delivered to the brakes.

* NOTICE

A click sound may be heard in the engine compartment when the vehicle begins to move after the engine is started. These conditions are normal and indicate that the anti-lock brake system is functioning properly.

- Even with the anti-lock brake system, your vehicle still requires sufficient stopping distance. Always maintain a safe distance from the vehicle in front of you.
- Always slow down when cornering. The anti-lock brake system cannot prevent accidents resulting from excessive speeds.
- On loose or uneven road surfaces, operation of the anti-lock brake system may result in a longer stopping distance than for vehicles equipped with a conventional brake system.



W-78

The ABS warning light will stay on for approximately 3 seconds after the ignition switch is ON. During that time, the ABS will go through self-diagnosis and the light will go off if everything is normal. If the light stays on, you may have a problem with your ABS but your regular brakes will work normally. Contact an authorized Kia dealer as soon as possible.

- When you drive on a road with poor traction, such as an icy road, and operated your brakes continuously, the ABS will be active continuously and the ABS warning light may illuminate. Pull your vehicle over to a safe place and stop the engine.
- Restart the engine. If the ABS warning light is off, then your ABS is normal. Otherwise, you may have a problem with the ABS. Contact an authorized Kia dealer as soon as possible.

* NOTICE

When you jump start your vehicle because of a drained battery, the engine may not run as smoothly and the ABS warning light may turn on at the same time. This happens because of the low battery voltage. It does not mean your ABS has malfunctioned.

- **Do not pump your brakes!**
- **Have the battery recharged before driving the vehicle.**

Electronic stability control (ESC)

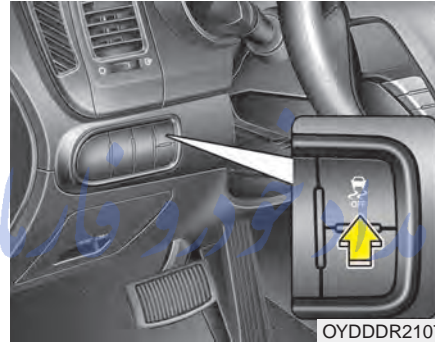

The Electronic Stability control (ESC) system is designed to stabilize the vehicle during cornering maneuvers. ESC checks where you are steering and where the vehicle is actually going. ESC applies the brakes on individual wheels and intervenes with the engine management system to stabilize the vehicle.

Electronic stability control (ESC) will not prevent accidents. Excessive speed in turns, abrupt maneuvers and hydroplaning on wet surfaces can still result in serious accidents. Only a safe and attentive driver can prevent accidents by avoiding maneuvers that cause the vehicle to lose traction. Even with ESC installed, always follow all the normal precautions for driving - including driving at safe speeds for the conditions.

The Electronic Stability Control (ESC) system is an electronic system designed to help the driver maintain vehicle control under adverse conditions. It is not a substitute for safe driving practices. Factors including speed, road conditions and driver steering input can all affect whether ESC will be effective in preventing a loss of control. It is still your responsibility to drive and corner at reasonable speeds and to leave a sufficient margin of safety.

When you apply your brakes under conditions which may lock the wheels, you may hear a “tik-tik” sound from the brakes, or feel a corresponding sensation in the brake pedal. This is normal and it means your ESC is active.

ESC operation

ESC ON condition



- When the ignition is turned ON, ESC and ESC OFF indicator lights illuminate for approximately 3 seconds, then ESC is turned on.
- Press the ESC OFF button for at least half a second after turning the ignition ON to turn ESC off. (ESC OFF indicator will illuminate). To turn the ESC on, press the ESC OFF button. (ESC OFF indicator light will go off).
- When starting the engine, you may hear a slight ticking sound. This is the ESC performing an automatic system self-check and does not indicate a problem.

When operating



When the ESC is in operation, ESC indicator light blinks.



- When the Electronic Stability Control is operating properly, you can feel a slight pulsation in the vehicle. This is only the effect of brake control and indicates nothing unusual.
- When moving out of the mud or slippery road, pressing the accelerator pedal may not cause the engine rpm (revolutions per minute) to increase.

ESC operation off**ESC OFF state**



This car has 2 kinds of ESC off states.

If the engine stops when ESC is off, ESC remains off. Upon restarting the engine, the ESC will automatically turn on again.

• ESC off state 1

To cancel ESC operation, press the ESC OFF button (ESC OFF ) shortly (ESC OFF indicator light (ESC OFF ) illuminates). At this state, the engine control function does not operate. It means the traction control function does not operate. Brake control function only operates.

• ESC off state 2

To cancel ESC operation, press the ESC OFF button (ESC OFF ) for more than 3 seconds. ESC OFF indicator light (ESC OFF ) illuminates and ESC OFF warning chime will sound. At this state, the engine control function and brake control function do not operate. It means the car stability control function does not operate any more.

Indicator light

■ ESC indicator light



■ ESC OFF indicator light



When the ignition switch is turned ON, the indicator light illuminates, then goes off if ESC system is operating normally.

The ESC indicator light blinks whenever ESC is operating.

The ESC indicator light blinks whenever ESC is operating or illuminates when ESC fails to operate.

The ESC OFF indicator light comes on when the ESC is turned off with the button.

تلفن شبانه روزی: ۰۲۱-۸۸۶۲۰۸۵

FarmaSOS.com

Driving with varying tire or wheel sizes may cause the ESC system to malfunction. When replacing tires, make sure they are the same size as your original tires.

⚠ WARNING - Electronic stability control

Drive carefully even though your vehicle has Electronic Stability Control. It can only assist you in maintaining control under certain circumstances.

ESC OFF usage

When driving

- It's a good idea to keep the ESC turned on for daily driving whenever possible.
- To turn ESC off while driving, press the ESC OFF button while driving on a flat road surface.

Never press the ESC OFF button while ESC is operating (ESC indicator light blinks).

If ESC is turned off while ESC is operating, the vehicle may slip out of control.

تلفن شبانه روزی: ۰۲۱-۸۸۸۶۲۰۸۵

⚠ WARNING - Operating ESC

Never press the ESC OFF button while ESC is operating.

If the ESC is turned off while ESC is operating, the vehicle may go out of control.

FarmaSOS.com

Hill-start assist control (HAC)

Hill start Assist Control is a comfort function. The main intent is to prevent the vehicle from rolling backwards while driving uphill on an inclined surface. HAC holds the braking pressure buildup by driver during stopping procedure for 2 seconds after releasing brake pedal.

During the pressure-hold period, the driver has enough time to press the accelerator pedal to drive off.

The braking pressure is reduced as soon as the system detects the driver's intention to drive off.

⚠ WARNING - Activating HAC

Drivers should pay close attention when activating the HAC. The vehicle may roll backward causing an accident due to insufficient brake hold pressure.

- The HAC does not operate when the transaxle shift lever is in the P (Park) or N (Neutral) position.
- The HAC activates even though the ESP is off but it does not activate when the ESP has malfunctioned.

امداد خودرو فارما

تلفن شبانه روزی: ۰۲۱-۸۸۸۶۲۰۸۵

FarmaSOS.com

Vehicle stability management (VSM)

This system provides further enhancements to vehicle stability and steering responses when a vehicle is driving on a slippery road or a vehicle detected changes in coefficient of friction between right wheels and left wheels when braking.

VSM operation

When the VSM is in operation, ESC indicator light () blinks.

When the vehicle stability management is operating properly, you can feel a slight pulsation in the vehicle and/or abnormal steering responses (EPS). This is only the effect of brake and EPS control and indicates nothing unusual.

The VSM does not operate when:

- Driving on bank roads such as gradient or incline
- Driving rearward
- ESC OFF indicator light () remains on the instrument cluster
- EPS indicator light remains on the instrument cluster

VSM operation off

If you press the ESC OFF button to turn off the ESC, the VSM will also cancel and the ESC OFF indicator light () illuminates.

To turn on the VSM, press the button again. The ESC OFF indicator light goes out.

Malfunction indicator

The VSM can be deactivated even if you don't cancel the VSM operation by pressing the ESC OFF button. It indicates that a malfunction has been detected somewhere in the Electric Power Steering system or VSM system. If the ESC indicator light () or EPS warning light remains on, take your vehicle to an authorized Kia dealer and have the system checked.

- The VSM is designed to function above approximately 9 mph (15 km/h) on curves.

- The VSM is designed to function above approximately 18 mph (30 km/h) when a vehicle is braking on a split-mu road. The split-mu road is made of surfaces which have different friction forces.
- The Vehicle Stability Management system is not a substitute for safe driving practices but a supplementary function only. It is the responsibility of the driver to always check the speed and the distance to the vehicle ahead. Always hold the steering wheel firmly while driving.
- Your vehicle is designed to activate according to the driver's intention, even with installed VSM. Always follow all the normal precautions for driving at safe speeds for the conditions – including driving in inclement weather and on a slippery road.

⚠ WARNING - Tire/Wheel size

When replacing tires and wheels, make sure they are the same size as the original tires and wheels installed. Driving with varying tire or wheel sizes may diminish any supplemental safety benefits of the VSM system.

Good braking practices

- Check to be sure the parking brake is not engaged and that the parking brake indicator light is out before driving away.
- Driving through water may get the brakes wet. They can also get wet when the vehicle is washed. Wet brakes can be dangerous! Your vehicle will not stop as quickly if the brakes are wet. Wet brakes may cause the vehicle to pull to one side.
To dry the brakes, apply the brakes lightly until the braking action returns to normal, taking care to keep the vehicle under control at all times. If the braking action does not return to normal, stop as soon as it is safe to do so and call an authorized Kia dealer for assistance.
- Don't coast down hills with the vehicle out of gear. This is extremely hazardous. Keep the vehicle in gear at all times, use the brakes to slow down, then shift to a lower gear so that engine braking will help you maintain a safe speed.

- Don't "ride" the brake pedal. Resting your foot on the brake pedal while driving can be dangerous because the brakes might overheat and lose their effectiveness. It also increases the wear of the brake components.
- If a tire goes flat while you are driving, apply the brakes gently and keep the vehicle pointed straight ahead while you slow down. When you are moving slowly enough for it to be safe to do so, pull off the road and stop in a safe place.
- If your vehicle is equipped with an automatic transaxle, don't let your vehicle creep forward. To avoid creeping forward, keep your foot firmly on the brake pedal when the vehicle is stopped.

- Be cautious when parking on a hill. Firmly engage the parking brake and place the shift lever in P (automatic transaxle) or in first or reverse gear (manual transaxle). If your vehicle is facing downhill, turn the front wheels into the curb to help keep the vehicle from rolling. If your vehicle is facing uphill, turn the front wheels away from the curb to help keep the vehicle from rolling. If there is no curb or if it is required by other conditions to keep the vehicle from rolling, block the wheels.
- Under some conditions your parking brake can freeze in the engaged position. This is most likely to happen when there is an accumulation of snow or ice around or near the rear brakes or if the brakes are wet. If there is a risk that the parking brake may freeze, apply it only temporarily while you put the shift lever in P (automatic transaxle) or in first or reverse gear (manual transaxle) and block the rear wheels so the vehicle cannot roll. Then release the parking brake.
- Do not hold the vehicle on the upgrade with the accelerator pedal. This can cause the transaxle to overheat. Always use the brake pedal or parking brake.

امداد خودرو فارما

تلفن شبانه روزی: ۰۲۱-۸۸۸۶۲۰۸۵

FarmaSOS.com

CRUISE CONTROL SYSTEM (IF EQUIPPED)

The cruise control system allows you to program the vehicle to maintain a constant speed without depressing the accelerator pedal.

This system is designed to function above approximately 40 km/h (25 mph).

If the cruise control is left on, (CRUISE indicator light in the instrument cluster illuminated) the cruise control can be switched on accidentally. Keep the cruise control system off (CRUISE indicator light OFF) when the cruise control is not in use, to avoid inadvertently setting a speed.

Use the cruise control system only when traveling on open highways in good weather.

Do not use the cruise control when driving in heavy or varying traffic, or on slippery (rainy, icy or snow-covered) or winding roads or over 6% up-hill or down-hill roads.

* NOTICE

- During normal cruise control operation, when the SET switch is activated or reactivated after applying the brakes, the cruise control will energize after approximately 3 seconds. This delay is normal.
- To activate cruise control, depress the brake pedal at least once after turning the ignition switch to the ON position or starting the engine. This is to check if the brake switch which is important part to cancel cruise control is in normal condition.

⚠ WARNING - Misuse of Cruise Control or Cruise Control Misuse

Do not use cruise control if the traffic situation does not allow you to drive safely at a constant speed and with sufficient distance to the vehicle in front.

Cruise control switch



CRUISE : Turns cruise control system on or off.

CANCEL: Cancels cruise control operation.

RES+: Resumes or increases cruise control speed.

SET-: Sets or decreases cruise control speed.

To set cruise control speed:



1. Press the CRUISE button on the steering wheel to turn the system on. The CRUISE indicator light in the instrument cluster will illuminate.
2. Accelerate to the desired speed, which must be more than 30 km/h (20 mph).

*** NOTICE - Manual transaxle**

For manual transaxle vehicles, you should depress the brake pedal at least once to set the cruise control after starting the engine.

امداد خودرو فارما

تلفن شبانه روزی: ۰۲۱-۸۸۸۶۲۰۸۵

FarmaSOS.com



3. Move the lever down (to SET-), and release it at the desired speed. The SET indicator light in the instrument cluster will illuminate. Release the accelerator pedal at the same time. The desired speed will automatically be maintained.

On a steep grade, the vehicle may slow down or speed up slightly while going uphill or downhill.

To increase cruise control set speed:



Follow either of these procedures:

- Move the lever up (to RES+) and hold it. Your vehicle will accelerate. Release the lever at the speed you want.
- Move the lever up (to RES+) and release it immediately.

The cruising speed will increase by 2 km/h (or 1 mph) each time you move the lever up (to RES+) in this manner.

To decrease the cruising speed:



Follow either of these procedures:

- Move the lever down (to SET-) and hold it. Your vehicle will gradually slow down. Release the lever at the speed you want to maintain.
- Move the lever down (to SET-) and release it immediately.

The cruising speed will decrease by 2 km/h (or 1 mph) each time you move the lever down (to SET-) in this manner.

To temporarily accelerate with the cruise control on:

If you want to speed up temporarily when the cruise control is on, depress the accelerator pedal. Increased speed will not interfere with cruise control operation or change the set speed.

To return to the set speed, take your foot off the accelerator pedal.

To cancel cruise control, do one of the following:



- Depress the brake pedal.
- Depress the clutch pedal with a manual transaxle.
- Shift into N (Neutral) with an automatic transaxle.
- Press the CANCEL button.
- Decrease the vehicle speed lower than the memory speed by 15 km/h (9 mph).
- Decrease the vehicle speed to less than approximately 40 km/h (25 mph).

Each of these actions will cancel cruise control operation (the SET indicator light in the instrument cluster will go off), but it will not turn the system off. If you wish to resume cruise control operation, move up the lever (to RES+) located on your steering wheel. You will return to your previously preset speed.

امداد خودرو فارما

تلفن شبانه روزی: ۰۲۱-۸۸۸۶۲۰۸۵

FarmaSOS.com

To resume cruising speed at more than approximately 40 km/h (25 mph):



If any method other than the CRUISE button was used to cancel cruising speed and the system is still activated, the most recent set speed will automatically resume when you move the lever up (to RES+).

It will not resume, however, if the vehicle speed has dropped below approximately 40 km/h (25 mph).

*** NOTICE**

Always check the road conditions when you move the lever up (to RES+) to resume the speed.

To turn cruise control off, do one of the following:



- Press the CRUISE button (the CRUISE indicator light in the instrument cluster will go off).
- Turn the ignition off.

Both of these actions cancel cruise control operation. If you want to resume cruise control operation, repeat the steps provided in "To set cruise control speed" on the previous page.

ACTIVE ECO SYSTEM (IF EQUIPPED)

Active ECO operation

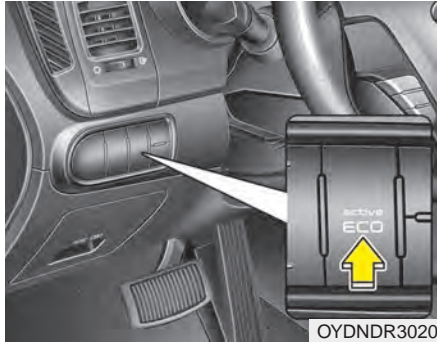

Active ECO helps improve fuel efficiency by controlling the engine and transaxle. But fuel-efficiency can be affected by the driver's driving habits and road conditions.

- When the Active ECO button is pressed the ECO indicator (green) will illuminate to show that the Active ECO is operating.
- When the Active ECO is activated, it does not turn off even though the engine is restarted again. To turn off the system, press the active ECO button again.
- If Active ECO is turned off, it will return to the normal mode.

Limitation of Active ECO operation:

If the following conditions occur while Active ECO is operating, the system operation is limited even though there is no change in the ECO indicator.

- When the coolant temperature is low:
The system will be limited until engine performance becomes normal.
- When driving up a hill:
The system will be limited to gain power when driving uphill because the engine torque is restricted.
- When using sports mode:
The system will be limited according to the shift location.
- When the accelerator pedal is fully pressed for a few seconds:
The system will be limited, as it has determined that the driver has accelerated judging that the driver wants to speed up.

ECONOMICAL OPERATION

Your vehicle's fuel economy depends mainly on your style of driving, where you drive and when you drive.

Each of these factors affects how many miles (kilometers) you can get from a gallon (liter) of fuel. To operate your vehicle as economically as possible, use the following driving suggestions to help save money in both fuel and repairs:

- Drive smoothly. Accelerate at a moderate rate. Don't make "jack-rabbit" starts or full-throttle shifts and maintain a steady cruising speed. Don't race between stoplights. Try to adjust your speed to the traffic so you don't have to change speeds unnecessarily. Avoid heavy traffic whenever possible. Always maintain a safe distance from other vehicles so you can avoid unnecessary braking. This also reduces brake wear.
- Drive at a moderate speed. The faster you drive, the more fuel your vehicle uses. Driving at a moderate speed, especially on the highway, is one of the most effective ways to reduce fuel consumption.
- Don't "ride" the brake pedal. This can increase fuel consumption and also increase wear on these components. In addition, driving with your foot resting on the brake pedal may cause the brakes to overheat, which reduces their effectiveness and may lead to more serious consequences.
- Take care of your tires. Keep them inflated to the recommended pressure. Incorrect inflation, either too much or too little, results in unnecessary tire wear. Check the tire pressures at least once a month.
- Be sure that the wheels are aligned correctly. Improper alignment can result from hitting curbs or driving too fast over irregular surfaces. Poor alignment causes faster tire wear and may also result in other problems as well as greater fuel consumption.
- Keep your vehicle in good condition. For better fuel economy and reduced maintenance costs, maintain your vehicle in accordance with the maintenance schedule in section 7. If you drive your vehicle in severe conditions, more frequent maintenance is required (see section 7 for details).
- Keep your vehicle clean. For maximum service, your vehicle should be kept clean and free of corrosive materials. It is especially important that mud, dirt, ice, etc. not be allowed to accumulate on the underside of the vehicle. This extra weight can result in increased fuel consumption and also contribute to corrosion.
- Travel lightly. Don't carry unnecessary weight in your vehicle. Weight reduces fuel economy.
- Don't let the engine idle longer than necessary. If you are waiting (and not in traffic), turn off your engine and restart only when you're ready to go.

- Remember, your vehicle does not require extended warm-up. After the engine has started, allow the engine to run for 10 to 20 seconds prior to placing the vehicle in gear. In very cold weather, however, give your engine a slightly longer warm-up period.
 - Don't "lug" or "over-rev" the engine. Lugging is driving too slowly in a very high gear resulting in engine bucking. If this happens, shift to a lower gear. Over-revving is racing the engine beyond its safe limit. This can be avoided by shifting at the recommended speed.
 - Use your air conditioning sparingly. The air conditioning system is operated by engine power so your fuel economy is reduced when you use it.
 - Open windows at high speeds can reduce fuel economy.
 - Fuel economy is reduced by crosswinds and headwinds. To help offset some of this loss, slow down when driving in these conditions.
- Keeping a vehicle in good operating condition is important both for economy and safety. Therefore, have an authorized Kia dealer perform scheduled inspections and maintenance.

FarmaSOS.com

⚠ WARNING - Engine off during motion

Never turn the engine off to coast down hills or anytime the vehicle is in motion. The power steering and power brakes will not function properly without the engine running. In addition, turning off the ignition while driving could engage the steering wheel lock resulting in loss of vehicle steering. Keep the engine on and downshift to an appropriate gear for engine braking effect.

SPECIAL DRIVING CONDITIONS

Hazardous driving conditions

When hazardous driving conditions are encountered such as water, snow, ice, mud, sand, or similar hazards, follow these suggestions:

- Drive cautiously and allow extra distance for braking.
- Avoid sudden braking or steering.
- When braking with non-ABS brakes pump the brake pedal with a light up-and-down motion until the vehicle is stopped.

Do not pump the brake pedal on a vehicle equipped with ABS.

- If stalled in snow, mud, or sand, use second gear. Accelerate slowly to avoid spinning the drive wheels.
- Use sand, rock salt, or other non-slip material under the drive wheels to provide traction when stalled in ice, snow, or mud.

WARNING - Downshifting

Do not downshift with an automatic transaxle while driving on slippery surfaces. The sudden change in tire speed could cause the tires to skid and result in an accident.

Rocking the vehicle

If it is necessary to rock the vehicle to free it from snow, sand, or mud, first turn the steering wheel right and left to clear the area around your front wheels. Then, shift back and forth between 1st (First) and R (Reverse) in vehicles equipped with a manual transaxle or R (Reverse) and any forward gear in vehicles equipped with an automatic transaxle. Do not race the engine, and spin the wheels as little as possible. If you are still stuck after a few tries, have the vehicle pulled out by a tow vehicle to avoid engine overheating and possible damage to the transaxle.

The ESC system should be turned OFF prior to rocking the vehicle.

CAUTION - Vehicle rocking

Prolonged rocking may cause engine overheating, transaxle damage or failure, and tire damage.

⚠ CAUTION - Spinning tires

Do not spin the wheels, especially at speeds more than 56 km/h (35 mph). Spinning the wheels at high speeds when the vehicle is stationary could cause a tire to overheat which could result in tire damage.

⚠ WARNING - Sudden vehicle movement

Do not attempt to rock the vehicle if people or objects are nearby. The vehicle may suddenly move forward or backwards as it becomes unstuck.

Smooth cornering



Avoid braking or gear changing in corners, especially when roads are wet. Ideally, corners should always be taken under gentle acceleration. If you follow these suggestions, tire wear will be held to a minimum.

Driving at night



Because night driving presents more hazards than driving in the daylight, here are some important tips to remember:

- Slow down and keep more distance between you and other vehicles, as it may be more difficult to see at night, especially in areas where there may not be any street lights.

- Adjust your mirrors to reduce the glare from other driver's headlights.
- Keep your headlights clean and properly aimed on vehicles not equipped with the automatic headlight aiming feature. Dirty or improperly aimed headlights will make it much more difficult to see at night.
- Avoid staring directly at the headlights of oncoming vehicles. You could be temporarily blinded, and it will take several seconds for your eyes to readjust to the darkness.

Driving in the rain



Rain and wet roads can make driving dangerous, especially if you're not prepared for the slick pavement. Here are a few things to consider when driving in the rain:

- A heavy rainfall will make it harder to see and will increase the distance needed to stop your vehicle, so slow down.
- Keep your windshield wiping equipment in good shape. Replace your windshield wiper blades when they show signs of streaking or missing areas on the windshield.

- If your tires are not in good condition, making a quick stop on wet pavement can cause a skid and possibly lead to an accident. Be sure your tires are in good shape.
- Turn on your headlights to make it easier for others to see you.
- Driving too fast through large puddles can affect your brakes. If you must go through puddles, try to drive through them slowly.
- If you believe you may have gotten your brakes wet, apply them lightly while driving until normal braking operation returns.

Driving in flooded areas

Avoid driving through flooded areas unless you are sure the water is no higher than the bottom of the wheel hub. Drive through any water slowly. Allow adequate stopping distance because brake performance may be affected.

After driving through water, dry the brakes by gently applying them several times while the vehicle is moving slowly.

Driving off-road

Drive carefully off-road because your vehicle may be damaged by rocks or roots of trees. Become familiar with the off-road conditions where you are going to drive before you begin driving.

Highway driving

Tires

Adjust the tire inflation pressures to specification. Low tire inflation pressures will result in overheating and possible failure of the tires.

Avoid using worn or damaged tires which may result in reduced traction or tire failure.

Never exceed the maximum tire inflation pressure shown on the tires.

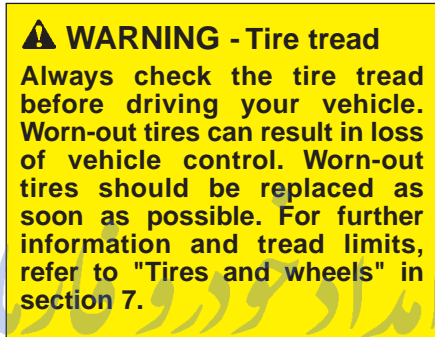

تلفن شبانه روزی: +۸۵-۸۸۸۶۲-۲۱

FarmaSOS.com

Fuel, engine coolant and engine oil

High speed travel consumes more fuel than urban motoring. Do not forget to check both the engine coolant and engine oil.

Drive belt

A loose or damaged drive belt may overheat the engine.

WINTER DRIVING



Severe weather conditions in the winter result in greater wear and other problems. To minimize the problems of winter driving, you should follow these suggestions:

Snowy or Icy conditions

To drive your vehicle in deep snow, it may be necessary to use snow tires on your tires. If snow tires are needed, it is necessary to select tires equivalent in size and type of the original equipment tires. Failure to do so may adversely affect the safety and handling of your car. Furthermore, speeding, rapid acceleration, sudden brake applications, and sharp turns are potentially very hazardous practices.

During deceleration, use engine braking to the fullest extent. Sudden brake applications on snowy or icy roads may cause skids. You need to keep sufficient distance between the vehicle in operation in front and your vehicle. Also, apply the brake gently.

Snow tires

If you mount snow tires on your vehicle, make sure they are radial tires of the same size and load range as the original tires. Mount snow tires on all four wheels to balance your vehicle's handling in all weather conditions. Keep in mind that the traction provided by snow tires on dry roads may not be as high as your vehicle's original equipment tires. You should drive cautiously even when the roads are clear. Check with the tire dealer for maximum speed recommendations.

Do not install studded tires without first checking local, state and municipal regulations for possible restrictions against their use.

Use high quality ethylene glycol coolant

Your vehicle is delivered with high quality ethylene glycol coolant in the cooling system. It is the only type of coolant that should be used because it helps prevent corrosion in the cooling system, lubricates the water pump and prevents freezing. Be sure to replace or replenish your coolant in accordance with the maintenance schedule in section 7. Before winter, have your coolant tested to assure that its freezing point is sufficient for the temperatures anticipated during the winter.

Check battery and cables

Winter puts additional burdens on the battery system. Visually inspect the battery and cables as described in section 7. The level of charge in your battery can be checked by an authorized Kia dealer or a service station.

Change to "winter weight" oil if necessary

In some climates it is recommended that a lower viscosity "winter weight" oil be used during cold weather. See section 8 for recommendations. If you aren't sure what weight oil you should use, consult an authorized Kia dealer.

Check spark plugs and ignition system

Inspect your spark plugs as described in section 7 and replace them if necessary. Also check all ignition wiring and components to be sure they are not cracked, worn or damaged in any way.

To keep locks from freezing

To keep the locks from freezing, squirt an approved de-icer fluid or glycerine into the key opening. If a lock is covered with ice, squirt it with an approved de-icing fluid to remove the ice. If the lock is frozen internally, you may be able to thaw it out by using a heated key. Handle the heated key with care to avoid injury.

Use approved window washer anti-freeze in system

To keep the water in the window washer system from freezing, add an approved window washer anti-freeze solution in accordance with instructions on the container. Window washer anti-freeze is available from an authorized Kia dealer and most auto parts outlets. Do not use engine coolant or other types of anti-freeze as these may damage the paint finish.

Don't let your parking brake freeze

Under some conditions your parking brake can freeze in the engaged position. This is most likely to happen when there is an accumulation of snow or ice around or near the rear brakes or if the brakes are wet. If there is a risk the parking brake may freeze, apply it only temporarily while you put the shift lever in P (automatic transaxle) or in first or reverse gear (manual transaxle) and block the rear wheels so the vehicle cannot roll. Then release the parking brake.

Don't let ice and snow accumulate underneath

Under some conditions, snow and ice can build up under the fenders and interfere with the steering. When driving in severe winter conditions where this may happen, you should periodically check underneath the car to be sure the movement of the front wheels and the steering components is not obstructed.

Carry emergency equipment

Depending on the severity of the weather you should carry appropriate emergency equipment. Some of the items you may want to carry include tow straps or chains, flashlight, emergency flares, sand, a shovel, jumper cables, a window scraper, gloves, ground cloth, coveralls, a blanket, etc.

تلفن شبانه روزی: ۰۲۱-۸۸۸۶۲۰۸۵

FarmaSOS.com

TRAILER TOWING

We do not recommend using this vehicle for trailer towing.

VEHICLE LOAD LIMIT

TIRE AND LOADING INFORMATION
RENSEIGNEMENTS SUR LES PNEUS ET LE CHARGEMENT

SEATING CAPACITY / NOMBRE DE PLACES: TOTAL 5, FRONT AVANT 2, REAR ARRIÈRE 3

The combined weight of occupants and cargo should never exceed 385 kg or 849 lbs. / Le poids total des occupants et du chargement ne doit jamais dépasser 385 kg ou 849 lbs.

TIRE PNEU	SIZE DIMENSIONS	COLD TIRE PRESSURE / PRESSION DES PNEUS À FROID	SEE OWNER'S MANUAL FOR ADDITIONAL INFORMATION / VOIR LE MANUEL DE L'USAGER POUR PLUS DE RENSEIGNEMENTS
FRONT AVANT	P195/65R15	220kPa, 32psi	
REAR ARRIÈRE	P195/65R15	220kPa, 32psi	
SPARE DE SECOURS	T125/80D15	420kPa, 60psi	

OYDNEM2010

TIRE AND LOADING INFORMATION
RENSEIGNEMENTS SUR LES PNEUS ET LE CHARGEMENT

SEATING CAPACITY / NOMBRE DE PLACES: TOTAL 5, FRONT AVANT 2, REAR ARRIÈRE 3

The combined weight of occupants and cargo should never exceed 385 kg or 849 lbs. / Le poids total des occupants et du chargement ne doit jamais dépasser 385 kg ou 849 lbs.

TIRE PNEU	SIZE DIMENSIONS	COLD TIRE PRESSURE / PRESSION DES PNEUS À FROID	SEE OWNER'S MANUAL FOR ADDITIONAL INFORMATION / VOIR LE MANUEL DE L'USAGER POUR PLUS DE RENSEIGNEMENTS
FRONT AVANT	P195/65R15	220kPa, 32psi	
REAR ARRIÈRE	P195/65R15	220kPa, 32psi	
SPARE DE SECOURS	NONE AUCUN		

OYDNEM2010C

TIRE AND LOADING INFORMATION
RENSEIGNEMENTS SUR LES PNEUS ET LE CHARGEMENT

SEATING CAPACITY / NOMBRE DE PLACES: TOTAL 5, FRONT AVANT 2, REAR ARRIÈRE 3

The combined weight of occupants and cargo should never exceed 385 kg or 849 lbs. / Le poids total des occupants et du chargement ne doit jamais dépasser 385 kg ou 849 lbs.

TIRE PNEU	SIZE DIMENSIONS	COLD TIRE PRESSURE / PRESSION DES PNEUS À FROID	SEE OWNER'S MANUAL FOR ADDITIONAL INFORMATION / VOIR LE MANUEL DE L'USAGER POUR PLUS DE RENSEIGNEMENTS
FRONT AVANT	P205/55R16	220kPa, 32psi	
REAR ARRIÈRE	P205/55R16	220kPa, 32psi	
SPARE DE SECOURS	T125/80D15	420kPa, 60psi	

OYDNEM2011

TIRE AND LOADING INFORMATION
RENSEIGNEMENTS SUR LES PNEUS ET LE CHARGEMENT

SEATING CAPACITY / NOMBRE DE PLACES: TOTAL 5, FRONT AVANT 2, REAR ARRIÈRE 3

The combined weight of occupants and cargo should never exceed 385 kg or 849 lbs. / Le poids total des occupants et du chargement ne doit jamais dépasser 385 kg ou 849 lbs.

TIRE PNEU	SIZE DIMENSIONS	COLD TIRE PRESSURE / PRESSION DES PNEUS À FROID	SEE OWNER'S MANUAL FOR ADDITIONAL INFORMATION / VOIR LE MANUEL DE L'USAGER POUR PLUS DE RENSEIGNEMENTS
FRONT AVANT	P205/55R16	220kPa, 32psi	
REAR ARRIÈRE	P205/55R16	220kPa, 32psi	
SPARE DE SECOURS	NONE AUCUN		

OYDNEM2011C

TIRE AND LOADING INFORMATION
RENSEIGNEMENTS SUR LES PNEUS ET LE CHARGEMENT

SEATING CAPACITY / NOMBRE DE PLACES: TOTAL 5, FRONT AVANT 2, REAR ARRIÈRE 3

The combined weight of occupants and cargo should never exceed 385 kg or 849 lbs. / Le poids total des occupants et du chargement ne doit jamais dépasser 385 kg ou 849 lbs.

TIRE PNEU	SIZE DIMENSIONS	COLD TIRE PRESSURE / PRESSION DES PNEUS À FROID	SEE OWNER'S MANUAL FOR ADDITIONAL INFORMATION / VOIR LE MANUEL DE L'USAGER POUR PLUS DE RENSEIGNEMENTS
FRONT AVANT	P215/45R17	220kPa, 32psi	
REAR ARRIÈRE	P215/45R17	220kPa, 32psi	
SPARE DE SECOURS	T125/80D15	420kPa, 60psi	

OYDNEM2012

TIRE AND LOADING INFORMATION
RENSEIGNEMENTS SUR LES PNEUS ET LE CHARGEMENT

SEATING CAPACITY / NOMBRE DE PLACES: TOTAL 5, FRONT AVANT 2, REAR ARRIÈRE 3

The combined weight of occupants and cargo should never exceed 385 kg or 849 lbs. / Le poids total des occupants et du chargement ne doit jamais dépasser 385 kg ou 849 lbs.

TIRE PNEU	SIZE DIMENSIONS	COLD TIRE PRESSURE / PRESSION DES PNEUS À FROID	SEE OWNER'S MANUAL FOR ADDITIONAL INFORMATION / VOIR LE MANUEL DE L'USAGER POUR PLUS DE RENSEIGNEMENTS
FRONT AVANT	P215/45R17	220kPa, 32psi	
REAR ARRIÈRE	P215/45R17	220kPa, 32psi	
SPARE DE SECOURS	NONE AUCUN		

OYDNEM2012C

Tire and loading information label

The label located on the driver's door sill gives the original tire size, cold tire pressures recommended for your vehicle, the number of people that can be in your vehicle and vehicle capacity weight.

Vehicle capacity weight:

385 kg (849 lbs.)

Vehicle capacity weight is the maximum combined weight of occupants and cargo. If your vehicle is equipped with a trailer, the combined weight includes the tongue load.

Seating capacity:

Total : 5 persons

(Front seat : 2 persons,
Rear seat : 3 persons)

Seating capacity is the maximum number of occupants including a driver, your vehicle may carry.

However, the seating capacity may be reduced based upon the weight of all of the occupants, and the weight of the cargo being carried or towed.

Do not overload the vehicle as there is a limit to the total weight, or load limit including occupants and cargo, the vehicle can carry.

Towing capacity:

We do not recommend using this vehicle for trailer towing.

Cargo capacity:

The cargo capacity of your vehicle will increase or decrease depending on the weight and the number of occupants and the tongue load, if your vehicle is equipped with a trailer.

Steps For Determining Correct Load Limit -

1. Locate the statement "The combined weight of occupants and cargo should never exceed XXX kg or XXX lbs." on your vehicle's placard.
2. Determine the combined weight of the driver and passengers that will be riding in your vehicle.
3. Subtract the combined weight of the driver and passengers from XXX kg or XXX lbs.
4. The resulting figure equals the available amount of cargo and luggage load capacity. For example, if the "XXX" amount equals 635 kg (1400 lbs.) and there will be five 68 kg (150 lbs.) passengers in your vehicle, the amount of available cargo and luggage load capacity is 295 kg (650 lbs).
(635-340 (5 x 68) = 295 kg or
1400-750 (5 x 150) = 650 lbs.)

5. Determine the combined weight of luggage and cargo being loaded on the vehicle. That weight may not safely exceed the available cargo and luggage load capacity calculated in Step 4.
6. If your vehicle will be towing a trailer, load from your trailer will be transferred to your vehicle. Consult this manual to determine how this reduces the available cargo and luggage load capacity of your vehicle.

Example 1

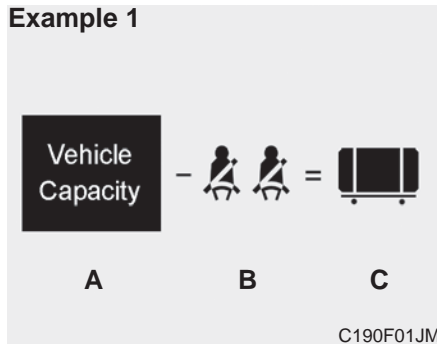

Item	Description	Total
A	Vehicle Capacity Weight	385 kg (849 lbs)
B	Subtract Occupant Weight 68 kg (150 lbs) × 2	136 kg (300 lbs)
C	Available Cargo and Luggage weight	249 kg (549 lbs)

Example 2

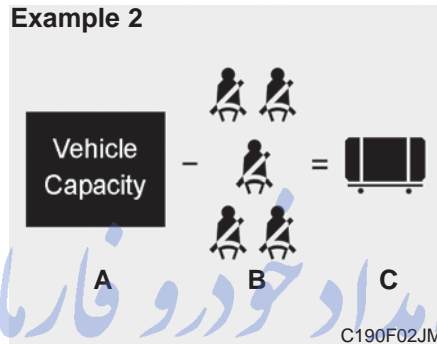

Item	Description	Total
A	Vehicle Capacity Weight	385 kg (849 lbs)
B	Subtract Occupant Weight 68 kg (150 lbs) × 5	340 kg (750 lbs)
C	Available Cargo and Luggage weight	45 kg (99 lbs)

Example 3

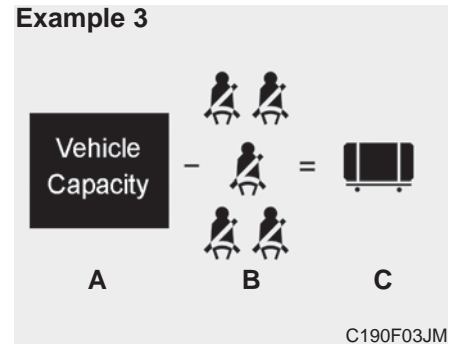

Item	Description	Total
A	Vehicle Capacity Weight	385 kg (849 lbs)
B	Subtract Occupant Weight 73 kg (161 lbs) × 3	365 kg (805 lbs)
C	Available Cargo and Luggage weight	20 kg (44 lbs)

Refer to your vehicle's tire and loading information label for specific information about your vehicle's capacity weight and seating positions. The combined weight of the driver, passengers and cargo should never exceed your vehicle's capacity weight.

Certification label

The certification label is located on the driver's door sill at the center pillar.

This label shows the maximum allowable weight of the fully loaded vehicle. This is called the GVWR (Gross Vehicle Weight Rating). The GVWR includes the weight of the vehicle, all occupants, fuel and cargo.

This label also tells you the maximum weight that can be supported by the front and rear axles, called Gross Axle Weight Rating (GAWR).

To find out the actual loads on your front and rear axles, you need to go to a weigh station and weigh your vehicle. Your dealer can help you with this. Be sure to spread out your load equally on both sides of the centerline.

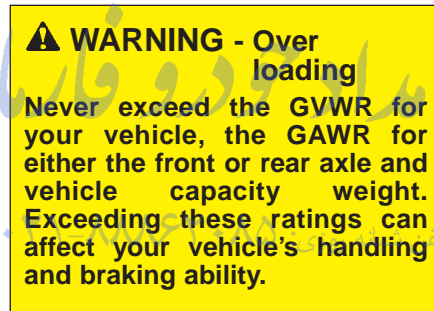

The label will help you decide how much cargo and installed equipment your vehicle can carry.

If you carry items inside your vehicle - like suitcases, tools, packages, or anything else - they are moving as fast as the vehicle. If you have to stop or turn quickly, or if there is a crash, the items will keep going and can cause an injury if they strike the driver or a passenger.

FarmaSOS.com

⚠ WARNING - Over loading

Do not overload your vehicle. Overloading your vehicle can cause heat buildup in your vehicle's tires and possible tire failure, increased stopping distances and poor vehicle handling--all of which may result in a crash.

⚠ WARNING - Loose cargo

Do not travel with unsecured blunt objects in the passenger compartment of your vehicle (e.g. suit cases or unsecured child seats). These items may strike occupant during a sudden stop or crash.

*** NOTICE**

Overloading your vehicle may cause damage. Repairs would not be covered by your warranty. Do not overload your vehicle.

تلفن شبانه روزی: ۰۲۱-۸۸۸۶۲۰۸۵

FarmaSOS.com

VEHICLE WEIGHT

This section will guide you in the proper loading of your vehicle and/or trailer, to keep your loaded vehicle weight within its design rating capability, with or without a trailer. Properly loading your vehicle will provide maximum return of the vehicle design performance. Before loading your vehicle, familiarize yourself with the following terms for determining your vehicle's weight ratings, with or without a trailer, from the vehicle's specifications and the compliance label:

Base curb weight

This is the weight of the vehicle including a full tank of fuel and all standard equipment. It does not include passengers, cargo, or optional equipment.

Vehicle curb weight

This is the weight of your new vehicle when you picked it up from your dealer plus any aftermarket equipment.

Cargo weight

This figure includes all weight added to the Base Curb Weight, including cargo and optional equipment.

GAW (Gross axle weight)

This is the total weight placed on each axle (front and rear) - including vehicle curb weight and all payload.

GAWR (Gross axle weight rating)

This is the maximum allowable weight that can be carried by a single axle (front or rear). These numbers are shown on the compliance label.

The total load on each axle must never exceed its GAWR.

GVW (Gross vehicle weight)

This is the Base Curb Weight plus actual Cargo Weight plus passengers.

GVWR (Gross vehicle weight rating)

This is the maximum allowable weight of the fully loaded vehicle (including all options, equipment, passengers and cargo). The GVWR is shown on the certification label located on the driver's door sill.

What to do in an emergency

Road warning	6-2	Towing	6-22
• Hazard warning flasher	6-2	• Towing service	6-22
In case of an emergency while driving.....	6-3	• Removable towing hook	6-23
• If the engine stalls at a crossroad or crossing.....	6-3	• Emergency towing.....	6-23
• If you have a flat tire while driving.....	6-3		
• If engine stalls while driving	6-3		
If the engine will not start.....	6-4		
• If engine doesn't turn over or turns over slowly	6-4		
• If engine turns over normally but does not start	6-4		
Emergency starting	6-5		
• Jump starting.....	6-5		
• Push-starting	6-6		
• If the engine overheats	6-7		
If you have a flat tire (with tire mobility kit)	6-8		
• Introduction.....	6-8		
• Notes on the safe use of the Tire Mobility Kit	6-9		
• Components of the TireMobilityKit	6-10		
• Using the Tire Mobility Kit	6-11		
If you have a flat tire (with spare tire).....	6-14		
• Jack and tools	6-14		
• Removing and storing the spare tire	6-15		
• Changing tires	6-15		

ROAD WARNING

Hazard warning flasher



The hazard warning flasher serves as a warning to other drivers to exercise extreme caution when approaching, overtaking, or passing your vehicle.

It should be used whenever emergency repairs are being made or when the vehicle is stopped near the edge of a roadway.

Depress the flasher switch with the ignition switch in any position. The flasher switch is located in the center console switch panel. All turn signal lights will flash simultaneously.

- The hazard warning flasher operates whether your vehicle is running or not.
- The turn signals do not work when the hazard flasher is on.
- Care must be taken when using the hazard warning flasher while the vehicle is being towed.

FarmaSOS.com

IN CASE OF AN EMERGENCY WHILE DRIVING

In an emergency situation while the vehicle is in motion, you are able to turn the engine off and to the ACC position by pressing the ENGINE START/STOP button for more than 2 seconds or 3 times successively within 3 seconds. If the vehicle is still moving, you can restart the engine without depressing the brake pedal by pressing the ENGINE START/STOP button with the shift lever in the N (Neutral) position (if smart key equipped).

If the engine stalls at a cross-road or crossing

If the engine stalls at a crossroad or crossing, set the shift lever in the N (Neutral) position and then push the vehicle to a safe place.

If you have a flat tire while driving

If a tire goes flat while you are driving:

1. Take your foot off the accelerator pedal and let the vehicle slow down while driving straight ahead. Do not apply the brakes immediately or attempt to pull off the road as this may cause a loss of control. When the vehicle has slowed down to such a speed that it is safe to do so, brake carefully and pull off the road. Drive off the road as far as possible and park on a firm level ground. If you are on a divided highway, do not park in the median area between the two traffic lanes.

2. When the vehicle is stopped, turn on your emergency hazard flashers, set the parking brake and put the transaxle in P (automatic transaxle) or reverse (manual transaxle).
3. Have all passengers get out of the vehicle. Be sure they all get out on the side of the vehicle that is away from traffic.
4. When changing a flat tire, follow the instruction provided later in this section.

If engine stalls while driving

1. Reduce your speed gradually, keeping a straight line. Move cautiously off the road to a safe place.
2. Turn on your emergency flashers.
3. Try to start the engine again. If your vehicle will not start, contact an authorized Kia dealer or seek other qualified assistance.

IF THE ENGINE WILL NOT START

If the engine doesn't turn over or turns over slowly

- 1.If your vehicle has an automatic transaxle, be sure the shift lever is in N (Neutral) or P (Park) and the emergency brake is set.
- 2.Check the battery connections to be sure they are clean and tight.
- 3.Turn on the interior light. If the light dims or goes out when you operate the starter, the battery is discharged.
- 4.Check the starter connections to be sure they are securely tightened.
- 5.Do not push or pull the vehicle to start it. See instructions for "Jump starting".

**⚠ WARNING - Push/
pull start**

Do not push or pull the vehicle to start it. Push or pull starting may cause the catalytic converter to overload and create a fire hazard.

If engine turns over normally but does not start

- 1.Check fuel level.
- 2.With the ignition switch in the LOCK position, check all connectors at the ignition coil and spark plugs. Reconnect any that may be disconnected or loose.
- 3.Check the fuel line in the engine compartment.
- 4.If the engine still does not start, call an authorized Kia dealer or seek other qualified assistance.

تلفن شبانه روزی: ۰۲۱-۸۸۸۶۲۰۸۵

FarmaSOS.com

EMERGENCY STARTING

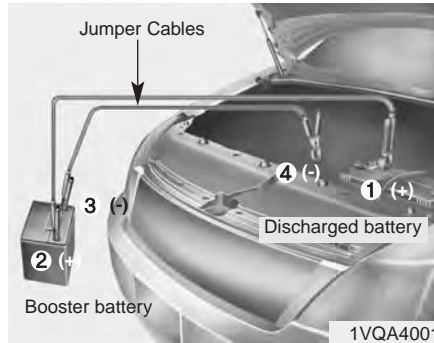

Connect cables in numerical order and disconnect in reverse order.

Jump starting

Jump starting can be dangerous if done incorrectly. Therefore, to avoid harm to yourself or damage to your vehicle or battery, follow these jump starting procedures. If in doubt, we strongly recommend that you have a competent technician or towing service jump start your vehicle.

⚠ CAUTION - 12 volt battery

Use only a 12-volt jumper system. You can damage a 12-volt starting motor, ignition system, and other electrical parts beyond repair by use of a 24-volt power supply (either two 12-volt batteries in series or a 24-volt motor generator set).

⚠ WARNING - Battery

Never attempt to check the electrolyte level of the battery as this may cause the battery to rupture or explode.

⚠ WARNING - Frozen batteries

Do not attempt to jump start the vehicle if the discharged battery is frozen or if the electrolyte level is low as the battery may rupture or explode.

⚠ WARNING - Battery

Keep all flames or sparks away from the battery. The battery produces hydrogen gas which will explode if exposed to flame or sparks.

⚠ WARNING - Sulfuric acid risk

When jump starting your vehicle be careful not to get acid on yourself, your clothing or on the vehicle. Automobile batteries contain sulfuric acid. This is poisonous and highly corrosive.

Jump starting procedure

1. Make sure the booster battery is 12-volt and that its negative terminal is grounded.
2. If the booster battery is in another vehicle, do not allow the vehicles to touch.
3. Turn off all unnecessary electrical loads.
4. Connect the jumper cables in the exact sequence shown in the illustration. First connect one end of a jumper cable to the positive terminal of the discharged battery (1), then connect the other end to the positive terminal on the booster battery (2).

Proceed to connect one end of the other jumper cable to the negative terminal of the booster battery (3), then the other end to a solid, stationary, metallic point (for example, the engine lifting bracket) away from the battery (4). Do not connect it to or near any part that moves when the engine is cranked.

Do not allow the jumper cables to contact anything except the correct battery terminals or the correct ground. Do not lean over the battery when making connections.

⚠ CAUTION - Battery cables

Do not connect the jumper cable from the negative terminal of the booster battery to the negative terminal of the discharged battery. This can cause the discharged battery to over-heat and crack, releasing battery acid.

5. Start the engine of the vehicle with the booster battery and let it run at 2,000 rpm, then start the engine of the vehicle with the discharged battery.

If the cause of your battery discharging is not apparent, you should have your vehicle checked by an authorized Kia dealer.

Push-starting

Your manual transaxle-equipped vehicle should not be push-started because it might damage the emission control system.

Vehicles equipped with automatic transaxle cannot be push-started.

Follow the directions in this section for jump-starting.

⚠ WARNING - Tow starting vehicle

Never tow a vehicle to start it because the sudden surge forward when the engine starts could cause a collision with the tow vehicle.

IF THE ENGINE OVERHEATS

If your temperature gauge indicates overheating, you will experience a loss of power, or hear loud pinging or knocking, the engine is probably too hot. If this happens, you should:

1. Pull off the road and stop as soon as it is safe to do so.
2. Place the shift lever in P (automatic transaxle) or neutral (manual transaxle) and set the parking brake. If the air conditioning is on, turn it off.
3. If engine coolant is running out under the vehicle or steam is coming out from underneath the hood, stop the engine. Do not open the hood until the coolant has stopped running or the steaming has stopped. If there is no visible loss of engine coolant and no steam, leave the engine running and check to be sure the engine cooling fan is operating. If the fan is not running, turn the engine off.

4. Check to see if the water pump drive belt is missing. If it is not missing, check to see that it is tight. If the drive belt seems to be satisfactory, check for coolant leaking from the radiator, hoses or under the vehicle. (If the air conditioning had been in use, it is normal for cold water to be draining from it when you stop).

⚠ WARNING - Under the hood

While the engine is running, keep hair, hands and clothing away from moving parts such as the fan and drive belts.

5. If the water pump drive belt is broken or engine coolant leaks, stop the engine immediately and call the nearest authorized Kia dealer for assistance.

⚠ WARNING - Radiator cap

Do not remove the radiator cap when the engine is hot. This can allow coolant to be blown out of the opening and cause serious burns.

6. If you cannot find the cause of the overheating, wait until the engine temperature has returned to normal. Then, if coolant has been lost, carefully add coolant to the reservoir to bring the fluid level in the reservoir up to the halfway mark.
7. Proceed with caution, keeping alert for further signs of overheating. If overheating happens again, call an authorized Kia dealer for assistance.

Serious loss of coolant indicates there is a leak in the cooling system and this should be checked as soon as possible by an authorized Kia dealer.

IF YOU HAVE A FLAT TIRE (WITH TIRE MOBILITY KIT, IF EQUIPPED)

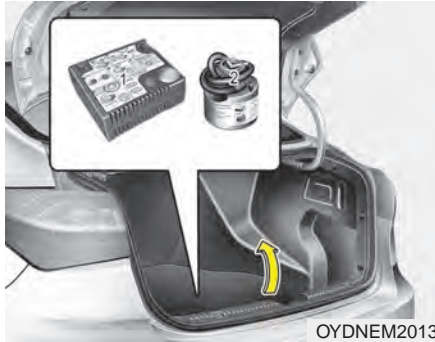

OYDNEM2013

For safe operation, carefully read and follow the instructions in this manual before use.

- (1) Compressor
- (2) Sealant bottle

The Tire Mobility Kit is a temporary fix to the tire and the tire should be inspected by an authorized Kia dealer as soon as possible.

⚠ CAUTION - One sealant bottle for one tire

The Tire Mobility Kit sealing compound in the bottle is to be used for one tire only. See your Kia dealership for additional replacement sealant bottles.

⚠ WARNING - Tire wall

Do not use the Tire Mobility Kit to repair punctures in the tire walls. This can result in an accident due to tire failure.

⚠ WARNING - Temporary fix

Have your tire repaired as soon as possible. The tire may lose air pressure at any time after inflating with the Tire Mobility Kit.

Introduction



OEL069019

With the Tire Mobility Kit you stay mobile even after experiencing a tire puncture.

The system of compressor and sealing compound effectively and comfortably seals most punctures in a passenger car tire caused by nails or similar objects and reinflates the tire.

After you ensured that the tire is properly sealed you can drive cautiously on the tire (up to 200 km (120 miles)) at a max. speed of 80 km/h (50 mph) in order to reach a service station or tire dealer to have the tire repaired or replaced.

It is possible that some tires, especially with larger punctures or damage to the sidewall, cannot be sealed completely.

Air pressure loss in the tire may adversely affect tire performance.

For this reason, you should avoid abrupt steering or other driving maneuvers, especially if the vehicle is heavily loaded or if a trailer is in use.

The Tire Mobility Kit is not designed or intended as a permanent tire repair method and is to be used for one tire only.

This instruction shows you step by step procedure to temporarily seal the puncture.

Read the section "Notes on the safe use of the Tire Mobility Kit".

Notes on the safe use of the Tire Mobility Kit

- Park your car at the side of the road so that you can work with the Tire Mobility Kit away from moving traffic.
- To be sure your vehicle will not move, even when you're on fairly level ground, always set your parking brake.
- Only use the Tire Mobility Kit for sealing/inflation passenger car tires. Only punctured areas located within the tread region of the tire can be sealed using the tire mobility kit.
- Do not use on motorcycles, bicycles or any other type of tires.
- When the tire and wheel are damaged, do not use Tire Mobility Kit for your safety.
- Use of the Tire Mobility Kit may not be effective for tire damage larger than approximately 6 mm (0.24 in). Please contact the nearest Kia dealership if the tire cannot be made roadworthy with the Tire Mobility Kit.

- Do not use the Tire Mobility Kit if a tire is severely damaged by driving run flat or with insufficient air pressure.
- Do not remove any foreign objects such as nails or screws that have penetrated the tire.
- Provided the car is outdoors, leave the engine running. Otherwise operating the compressor may eventually drain the car battery.
- Never leave the Tire Mobility Kit unattended while it is being used.
- Do not leave the compressor running for more than 10 min. at a time or it may overheat.
- Do not use the Tire Mobility Kit if the ambient temperature is below -30°C (22°F).

Components of the TireMobilityKit

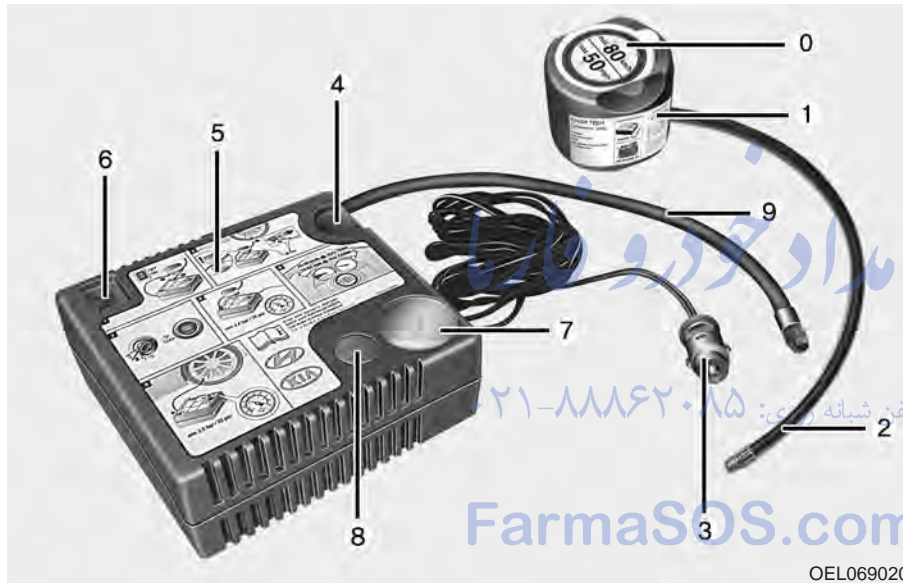

0. Speed restriction label
1. Sealant bottle and label with speed restriction
2. Filling hose from sealant bottle to wheel
3. Connectors and cable for the power outlet direct connection
4. Holder for the sealant bottle
5. Compressor
6. On/off switch
7. Pressure gauge for displaying the tire inflation pressure
8. Button for reducing tire inflation pressure
9. Hose to connect compressor and sealant bottle or compressor and wheel

9. Hose to connect compressor and sealant bottle or compressor and wheel

Connectors, cable and connection hose are stored in the compressor housing.

⚠ WARNING - Expired sealant

Do not use the Tire sealant after expiration date noted on the sealant bottle. This can increase the risk of tire failure.

⚠ WARNING - Sealant

- Keep out of reach of children.
- Avoid contact with eyes.
- Do not swallow.

Strictly follow the specified sequence, otherwise the sealant may escape under high pressure.

Using the Tire Mobility Kit

1. Detach the speed restriction label (0) from the sealant bottle (1), and place it in a highly visible place inside the vehicle such as on the steering wheel to remind the driver not to drive too fast.
2. Screw connection hose (9) onto the connector of the sealant bottle.
3. Ensure that button (8) on the compressor is not pressed.
4. Unscrew the valve cap from the valve of the defective wheel and screw filling hose (2) of the sealant bottle onto the valve.
5. Insert the sealant bottle into the housing of the compressor (4) so that the bottle is upright.

* NOTICE

If a foreign object is seen that has punctured the tire, do not remove it before using Tire Mobility Kit.



6. Ensure that the compressor is switched off, position 0.
7. Connect between compressor and the vehicle power outlet using the cable and connectors.
8. With the engine start/stop button position on or ignition switch position on, switch on the compressor and let it run for approximately 5~7 minutes to fill the sealant up to proper pressure. (refer to the Tire and Wheels, chapter 8). The inflation pressure of the tire after filling is unimportant and will be checked/corrected later.

Be careful not to overinflate the tire and stay away from the tire when filling it.

⚠ CAUTION - Tire pressure
Do not attempt to drive your vehicle if the tire pressure is below 200kpa (29 PSI). This could result in an accident due to sudden tire failure.

9. Switch off the compressor.
10. Detach the hoses from the sealant bottle connector and from the tire valve.

Return the Tire Mobility Kit to its storage location in the vehicle.

⚠ WARNING
Carbon monoxide poisoning and suffocation is possible if the engine is left running in a poorly ventilated or unventilated location (such as inside a building).

Distributing the sealant

11. Immediately drive approximately 7~10km (4~6miles or, about 10min) to evenly distribute the sealant in the tire.

Do not exceed a speed of 80 km/h (50 mph). If possible, do not fall below a speed of 20 km/h (12 mph).

While driving, if you experience any unusual vibration, ride disturbance or noise, reduce your speed and drive with caution until you can safely pull off of the side of the road.

Call for road side service or towing.

When you use the Tire Mobility Kit, the tire pressure sensor valve stem and wheel may be stained by sealant. After use wipe off sealant residue and inspect. Consult you Kia dealership if necessary.

Checking the tire inflation pressure

1. After driving approximately 7 ~ 10 km (4 ~ 6 miles or about 10 min), stop at a safe location.
2. Connect connection hose (9) of the compressor directly to the tire valve.
3. Plug the compressor power cord into the vehicle power outlet.
4. Adjust the tire inflation pressure to the recommended tire inflation.

With the ignition switch on, proceed as follows.

- **To increase the inflation pressure** : Switch on the compressor, position I. To check the current inflation pressure setting, briefly switch off the compressor.

* NOTICE

The pressure gauge may show higher than actual reading when the compressor is running. To get an accurate tire reading, the compressor needs to be turned off.

- **To reduce the inflation pressure**: Press the button 8 on the compressor.

⚠ CAUTION - Tire pressure sensor

When you use the Tire Mobility Kit including sealant not approved by Kia, the tire pressure sensors may be damaged by sealant. The sealant on the tire pressure sensor and wheel should be removed when you replace the tire with a new one and inspect the tire pressure sensors at an authorized dealer.

Technical Data

System voltage : DC 12 V

Working voltage : DC 10 - 15 V

Amperage rating : max. 15 A

Suitable for use at temperatures :

-30 ~ +70°C (-22 ~ +158°F)

Max. working pressure :

6 bar (87 psi)

Size

Compressor : 168 x 150 x 68 mm

(6.6 x 5.9 x 2.7 in.)

Sealant bottle : 104 x ø 85 mm

(4.1 x ø 3.3 in.)

Compressor weight :

1.05 kg (2.31 lbs)

Sealant volume :

300 ml (18.3 cu. in.)

Sealant warranty :

5 years (sealant.)

IF YOU HAVE A FLAT TIRE (IF EQUIPPED)

Jack and tools

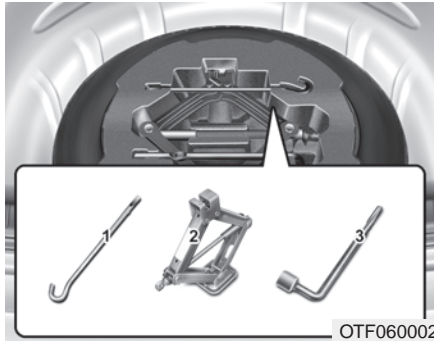

The spare tire, jack, jack handle and wheel lug nut wrench are stored in the luggage compartment.

Remove the luggage under tray out of the way to reach the equipment.

- (1) Jack handle
- (2) Jack
- (3) Wheel lug nut wrench

Jacking instructions

The jack is provided for emergency tire changing only.

To prevent the jack from “rattling” while the vehicle is in motion, store it properly.

Follow jacking instructions to reduce the possibility of personal injury.

⚠ WARNING - Changing tires

Never attempt vehicle repairs in the traffic lanes of a public road or highway.

Always move the vehicle completely off the road and onto the shoulder before trying to change a tire. The jack should be used on firm level ground. If you cannot find a firm level place off the road, call a towing service company for assistance.

Be sure to use the correct front and rear jacking positions on the vehicle; never use the bumpers or any other part of the vehicle for jack support.

⚠ WARNING - Tire Jack

Do not place any portion of your body under a vehicle that is only supported by a jack since the vehicle can easily roll off the jack. Use vehicle support stands.

FarmaSOS.com

Do not allow anyone to remain in the vehicle while it is on the jack.

Make sure any children present are in a secure place away from the road and from the vehicle to be raised with the jack.

⚠ WARNING - Running vehicle on jack

Do not start or run the engine of the vehicle while the vehicle is on the jack as this may cause the vehicle to fall off the jack.

Removing and storing the spare tire



ONF068004

Turn the tire hold-down wing bolt counterclockwise.

Store the tire in the reverse order of removal.

To prevent the spare tire and tools from “rattling” while the vehicle is in motion, store them properly.

Changing tires



OED066033

1. Park on a level surface and apply the parking brake firmly.
2. Shift the shift lever into R (Reverse) for manual transaxle or P (Park) for automatic transaxle.
3. Activate the hazard warning flashers.

What to do in an emergency



4. Remove the wheel lug nut wrench, jack, jack handle, and spare tire from the vehicle.
5. Block both the front and rear of the wheel that is diagonally opposite the jack position.

To prevent vehicle movement while changing a tire, always set the parking brake fully, and always block the wheel diagonally opposite the wheel being changed.

We recommend that the wheels of the vehicle be chocked, and that no person remain in a vehicle that is being jacked.

امداد خودرو فارما

تلفن شبانه روزی: ۰۲۱-۸۸۸۶۲۰۸۵

FarmaSOS.com



6. Loosen the wheel lug nuts counter-clockwise one turn each, but do not remove any nut until the tire has been raised off the ground.

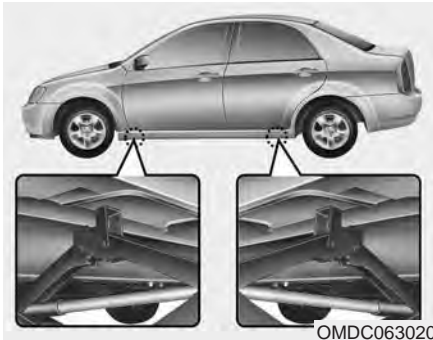

7. Place the jack at the front or rear jacking position closest to the tire you are changing. Place the jack at the designated locations under the frame. The jacking positions are plates welded to the frame with two tabs and a raised dot to index with the jack.

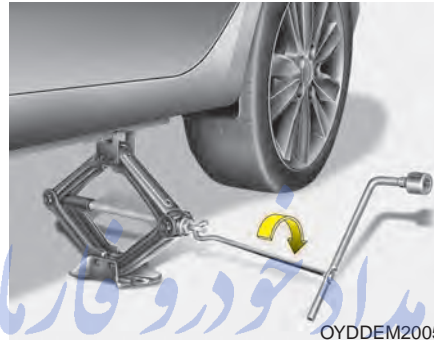

8. Insert the jack handle into the jack and turn it clockwise, raising the vehicle until the tire just clears the ground. This measurement is approximately 30 mm (1 in). Before removing the wheel lug nuts, make sure the vehicle is stable and that there is no chance for movement or slippage.

9. Loosen the wheel nuts and remove them with your fingers. Slide the wheel off the studs and lay it flat so it cannot roll away. To put the wheel on the hub, pick up the spare tire, line up the holes with the studs and slide the wheel onto them. If this is difficult, tip the wheel slightly and get the top hole in the wheel lined up with the top stud. Then jiggle the wheel back and forth until the wheel can be slid over the other studs.

Wheels and wheel covers may have sharp edges. Handle them carefully to avoid possible injury. Before putting the wheel into place, be sure that there is nothing on the hub or wheel (such as mud, tar, gravel, etc.) that prevents the wheel from fitting solidly against the hub.

⚠ WARNING - Installing a wheel

Make sure the wheel makes good contact with the hub when installed. If the contact of the mounting surface between the wheel and hub is not good, the wheel nuts could come loose and cause the loss of a wheel. Loss of a wheel may result in loss of control of the vehicle.

10. To install the wheel, hold it on the studs, put the wheel nuts on the studs and tighten them finger tight. Jiggle the tire to be sure it is completely seated, then tighten the nuts as much as possible with your fingers again.
11. Lower the vehicle to the ground by turning the wheel nut wrench counterclockwise.



Then position the wrench as shown in the drawing and tighten the wheel nuts. Be sure the socket is seated completely over the nut. Do not stand on the wrench handle or use an extension pipe over the wrench handle.

Go around the wheel tightening every nut following the numerical sequence shown in the image until they are tight. Then double-check each nut for tightness. After changing the wheels, have an authorized Kia dealer tighten the wheel nuts to their proper torque as soon as possible.

Wheel nut tightening torque:

Steel wheel & aluminium alloy wheel:
9~11 kg.m (65~79 lb.ft)

امداد خودرو فارما

تلفن شبانه روزی: ۰۲۱-۸۸۸۶۲۰۸۵

FarmaSOS.com

If you have a tire gauge, remove the valve cap and check the air pressure. If the pressure is lower than recommended, drive slowly to the nearest service station and inflate to the correct pressure. If it is too high, adjust it until it is correct. Always reinstall the valve cap after checking or adjusting the tire pressure. If the cap is not replaced, air may leak from the tire. If you lose a valve cap, buy another and install it as soon as possible.

After you have changed wheels, always secure the flat tire in its place and return the jack and tools to their proper storage locations.

 **CAUTION - Replacing lug nuts**

Make certain during wheel removal that the same nuts that were removed are reinstalled - or, if replaced, that nuts with metric threads and the same chamfer configuration are used. Your vehicle has metric threads on the wheel studs and nuts. Installation of a non-metric thread nut on a metric stud will not secure the wheel to the hub properly and will damage the stud so that it must be replaced.

Note that most lug nuts do not have metric threads. Be sure to use extreme care in checking for thread style before installing aftermarket lug nuts or wheels. If in doubt, consult an authorized Kia dealer.

 **WARNING - Wheel studs**

Do not drive your vehicle with damaged wheel studs. If the studs are damaged, they may lose their ability to retain the wheel. This could lead to the loss of the wheel and a collision.

To prevent the jack, jack handle, wheel lug nut wrench and spare tire from rattling while the vehicle is in motion, store them properly.

Check the inflation pressures as soon as possible after installing the spare tire. Adjust it to the specified pressure, if necessary. Refer to "Tires and wheels" in section 8.

Important - use of compact spare tire (if equipped)

Your vehicle is equipped with a compact spare tire. This compact spare tire takes up less space than a regular-size tire. This tire is smaller than a conventional tire and is designed for temporary use only.

You should drive carefully when the compact spare is in use. The compact spare should be replaced by the proper conventional tire and rim at the first opportunity.

The operation of this vehicle is not recommended with more than one compact spare tire in use at the same time.

⚠ WARNING - Spare tire

Do not operate your vehicle on this compact spare at speeds over 80 km/h (50 mph). The compact spare tire is for emergency use only. The original tire should be repaired or replaced as soon as possible to avoid failure of the spare.

The compact spare should be inflated to 420 kPa (60 psi).

Check the inflation pressure after installing the spare tire. Adjust it to the specified pressure, as necessary.

When using a compact spare tire, observe the following precautions:

- Under no circumstances should you exceed 80 km/h (50 mph); a higher speed could damage the tire.
- Ensure that you drive slowly enough for the road conditions to avoid all hazards. Any road hazard, such as a pothole or debris, could seriously damage the compact spare.
- Any continuous road use of this tire could result in tire failure, loss of vehicle control, and possible personal injury.
- Do not exceed the vehicle's maximum load rating or the load-carrying capacity shown on the sidewall of the compact spare tire.
- Avoid driving over obstacles. The compact spare tire diameter is smaller than the diameter of a conventional tire and reduces the ground clearance approximately 25 mm (1 inch), which could result in damage to the vehicle.

FarmaSOS.com

- Do not take this vehicle through an automatic car wash while the compact spare tire is installed.
 - The compact spare tire should not be installed on the front axle if the vehicle must be driven in snow or on ice.
 - Do not use the compact spare tire on any other vehicle because this tire has been designed especially for your vehicle.
 - The compact spare tire's tread life is shorter than a regular tire. Inspect your compact spare tire regularly and replace worn compact spare tires with the same size and design, mounted on the same wheel.
 - The compact spare tire should not be used on any other wheels, nor should standard tires, snow tires, wheel covers or trim rings be used with the compact spare wheel. If such use is attempted, damage to these items or other car components may occur.
- Do not use more than one compact spare tire at a time.
 - Do not tow a trailer while the compact spare tire is installed.

امداد خودرو فارما

تلفن شبانه روزی: ۰۲۱-۸۸۸۶۲۰۸۵

FarmaSOS.com

TOWING

Towing service

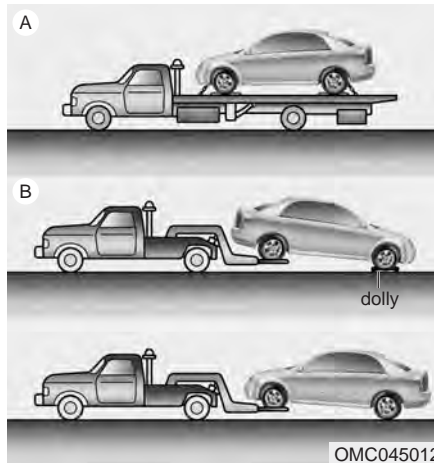

If emergency towing is necessary, we recommend having it done by an authorized Kia dealer or a commercial tow-truck service. Proper lifting and towing procedures are necessary to prevent damage to the vehicle. The use of wheel dollies or flatbed is recommended.

It is acceptable to tow the vehicle with the rear wheels on the ground (without dollies) and the front wheels off the ground.

If any of the loaded wheels or suspension components are damaged or the vehicle is being towed with the front wheels on the ground, use a towing dolly under the front wheels.

When being towed by a commercial tow truck and wheel dollies are not used, the front of the vehicle should always be lifted, not the rear.

تلفن شبانه روزی: ۰۲۱-۸۸۶۲۰۸۵

FarmaSOS.com

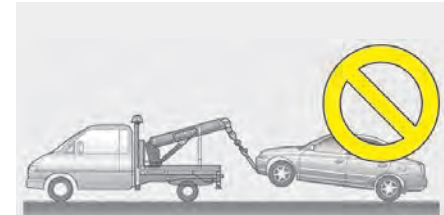

HXD02

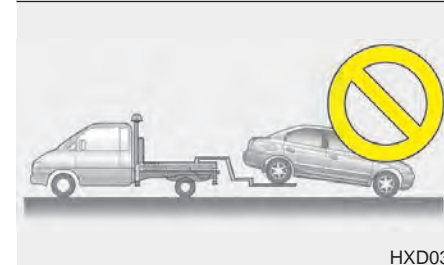

HXD03

⚠ CAUTION - Towing

- **Do not tow the vehicle backwards with the front wheels on the ground as this may cause damage to the vehicle.**
- **Do not tow with sling-type equipment. Use wheel lift or flatbed equipment.**

When towing your vehicle in an emergency without wheel dollies :

1. Set the ignition switch in the ACC position.
2. Place the transaxle shift lever in N (Neutral).
3. Release the parking brake.

⚠ CAUTION - Towing gear position

Always place the transaxle shift lever in N (Neutral) when towing your vehicle. Failure to place the transaxle shift lever in N (Neutral) may cause internal damage to the transaxle.

Removable towing hook (front) (if equipped)

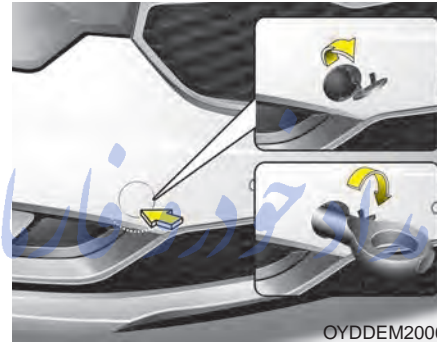

1. Remove the towing hook from the tool case.
2. Remove the hole cover pressing the lower part of the cover on the front bumper.
3. Install the towing hook by turning it clockwise into the hole until it is fully secured.
4. Remove the towing hook and install the cover after use.

Emergency towing

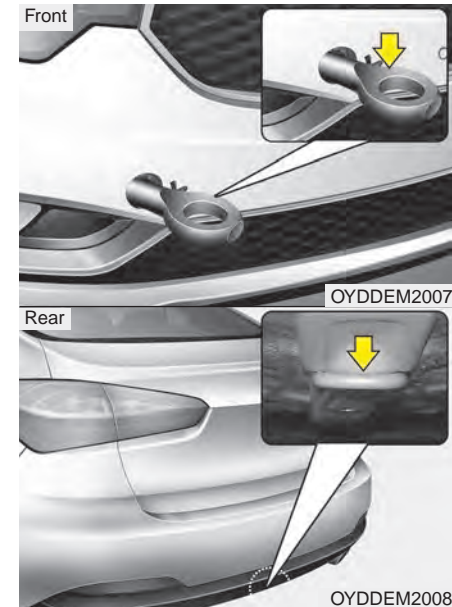

If towing is necessary, we recommend you have it done by an authorized Kia dealer or a commercial tow truck service.

What to do in an emergency

If towing service is not available in an emergency, your vehicle may be temporarily towed using a cable or chain secured to the emergency towing hook under the front (or rear) of the vehicle. Use extreme caution when towing the vehicle. A driver must be in the vehicle to steer it and operate the brakes.

Towing in this manner may be done only on hard-surfaced roads for a short distance and at low speeds. Also, the wheels, axles, power train, steering and brakes must all be in good condition.

- Do not use the towing hooks to pull a vehicle out of mud, sand or other conditions from which the vehicle cannot be driven out under its own power.
- Avoid towing a vehicle heavier than the vehicle doing the towing.
- The drivers of both vehicles should communicate with each other frequently.

- Attach a towing strap to the towing hook.
- Using a portion of the vehicle other than the tow hooks for towing may damage the body of your vehicle.
- Use only a cable or chain specifically intended for use in towing vehicles. Securely fasten the cable or chain to the towing hook provided.
- Before emergency towing, check that the hook is not broken or damaged.
- Fasten the towing cable or chain securely to the hook.
- Do not jerk the hook. Apply it steadily with even force.
- To avoid damaging the hook, do not pull from the side or at a vertical angle. Always pull straight ahead.

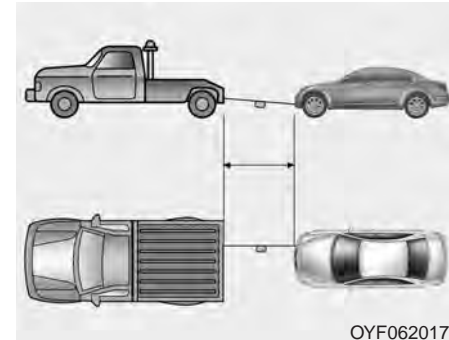

- Use a towing strap less than 5 m (16 feet) long. Attach a white or red cloth (about 30 cm (12 inches) wide) in the middle of the strap for easy visibility.
- Drive carefully so that the towing strap is not loosened during towing.

Emergency towing precautions

- Turn the ignition switch to ACC so the steering wheel isn't locked.
- Place the transaxle shift lever in N (Neutral).
- Release the parking brake.
- Press the brake pedal with more force than normal since you will have reduced brake performance.
- More steering effort will be required because the power steering system will be disabled.
- If you are driving down a long hill, the brakes may overheat and brake performance will be reduced. Stop often and let the brakes cool off.

If the car is being towed with all four wheels on the ground, it can be towed only from the front. Be sure that the transmission is in neutral. Be sure the steering is unlocked by placing the ignition switch in the ACC position. A driver must be in the towed vehicle to operate the steering and brakes.

⚠ CAUTION - Automatic transaxle

- ***To avoid serious damage to the automatic transmission, limit the vehicle speed to 15 km/h (10 mph) and drive less than 1.5 km (1 mile) when towing.***
- ***Before towing, check for an automatic transmission fluid leak under your vehicle. If the automatic transmission fluid is leaking, a flatbed equipment or towing dolly must be used.***

Maintenance

Engine compartment	7-3	Climate control air filter	7-37
Maintenance services	7-4	• Filter inspection	7-37
• Owner's responsibility	7-4	Wiper blades	7-38
• Owner maintenance precautions	7-5	• Blade inspection	7-38
Owner maintenance	7-6	• Blade replacement	7-38
• Owner maintenance schedule	7-6	Battery	7-41
Scheduled maintenance service	7-8	• For best battery service	7-41
• Normal maintenance schedule	7-10	• Battery recharging	7-43
• Maintenance under severe usage conditions	7-23	• Reset items	7-43
Explanation of scheduled maintenance items	7-25	Tires and wheels	7-44
Engine oil	7-29	• Tire care	7-44
• Checking the engine oil level	7-29	• Recommended cold tire inflation pressures	7-44
• Changing the engine oil and filter	7-30	• Checking tire inflation pressure	7-45
Engine coolant	7-31	• Tire rotation	7-46
• Checking the coolant level	7-31	• Wheel alignment and tire balance	7-47
• Changing the coolant	7-33	• Tire replacement	7-48
Brake/clutch fluid	7-34	• Wheel replacement	7-49
• Checking the brake/clutch fluid level	7-34	• Tire traction	7-49
Washer fluid	7-35	• Tire maintenance	7-49
• Checking the washer fluid level	7-35	• Tire sidewall labeling	7-49
Parking brake	7-35	• All season tires	7-55
• Checking the parking brake	7-35	• Summer tires	7-55
Air cleaner	7-36	• Snow tires	7-55
• Filter replacement	7-36	• Radial-ply tires	7-56
		• Low aspect ratio tire	7-56

Fuses	7-58
• Instrument panel fuse replacement	7-59
• Engine compartment fuse replacement	7-61
• Fuse/relay panel description	7-63
• Engine compartment fuse panel	7-64
• Engine room (Battery terminal cover)	7-65
Appearance care	7-71
• Exterior care	7-71
• Interior care	7-76
Emission control system	7-78
• Crankcase emission control system	7-78
• Evaporative emission control (including ORVR: Onboard Refueling Vapor Recovery) system	7-78
• Exhaust emission control system	7-79

امداد خودرو فارما

تلفن شبانه روزی: ۰۲۱-۸۸۶۲۰۸۵

FarmaSOS.com

ENGINE COMPARTMENT

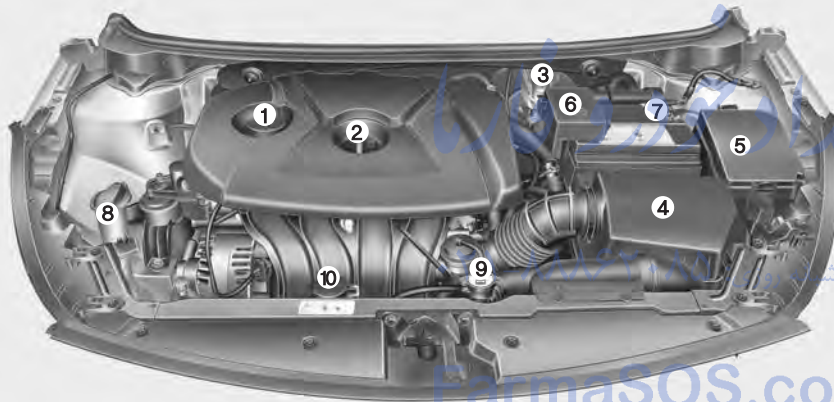

1. Engine oil filler cap
2. Engine oil dipstick
3. Brake/clutch fluid reservoir
4. Air cleaner
5. Fuse box
6. Positive battery terminal
7. Negative battery terminal
8. Windshield washer fluid reservoir
9. Radiator cap
10. Engine coolant reservoir

* The actual engine room in the vehicle may differ from the illustration.

OYDNMC2041

MAINTENANCE SERVICES

You should exercise the utmost care to prevent damage to your vehicle and injury to yourself whenever performing any maintenance or inspection procedures.

Should you have any doubts concerning the inspection or servicing of your vehicle, we strongly recommend that you have an authorized Kia dealer perform this work.

An authorized Kia dealer has factory-trained technicians and genuine Kia parts to service your vehicle properly. For expert advice and quality service, see an authorized Kia dealer.

Inadequate, incomplete or insufficient servicing may result in operational problems with your vehicle that could lead to vehicle damage, an accident, or personal injury.

Owner's responsibility

* NOTICE

Maintenance Service and Record Retention are the owner's responsibility.

You should retain documents that show proper maintenance has been performed on your vehicle in accordance with the scheduled maintenance service charts shown on the following pages. You need this information to establish your compliance with the servicing and maintenance requirements of your vehicle warranties.

Detailed warranty information is provided in your Warranty & Consumer Information manual.

Repairs and adjustments required as a result of improper maintenance or a lack of required maintenance are not covered.

We recommend you have your vehicle maintained and repaired by an authorized Kia dealer. An authorized Kia dealer meets Kia's high service quality standards and receives technical support from Kia in order to provide you with a high level of service satisfaction.

Owner maintenance precautions

Improper or incomplete service may result in problems. This section gives instructions only for the maintenance items that are easy to perform.

As explained earlier in this section, several procedures can be done only by an authorized Kia dealer with special tools.

* NOTICE

Improper owner maintenance during the warranty period may affect warranty coverage. For details, read the separate Warranty & Consumer Information manual provided with the vehicle. If you're unsure about any servicing or maintenance procedure, have it done by an authorized Kia dealer.

⚠ WARNING - Maintenance work

Do not wear jewelry or loose clothing while working under the hood of your vehicle with the engine running. These can become entangled in moving parts, if you must run the engine while working under the hood, make certain that you remove all jewelry (especially rings, bracelets, watches, and necklaces) and all neckties, scarves, and similar loose clothing before getting near the engine or cooling fans.

FarmaSOS.com

OWNER MAINTENANCE

The following lists are vehicle checks and inspections that should be performed by the owner or an authorized Kia dealer at the frequencies indicated to help ensure safe, dependable operation of your vehicle.

Any adverse conditions should be brought to the attention of your dealer as soon as possible.

These Owner Maintenance Checks are generally not covered by warranties and you may be charged for labor, parts and lubricants used.

Owner maintenance schedule

When you stop for fuel:

- Check the engine oil level.
- Check the coolant level in coolant reservoir.
- Check the windshield washer fluid level.
- Look for low or under-inflated tires.

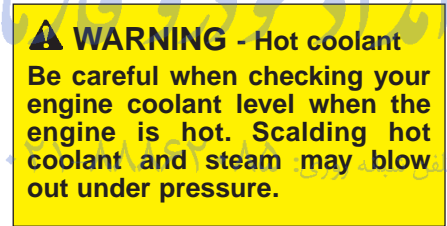

While operating your vehicle:

- Note any changes in the sound of the exhaust or any smell of exhaust fumes in the vehicle.
- Check for vibrations in the steering wheel. Notice any increased steering effort or looseness in the steering wheel, or change in its straight-ahead position.
- Notice if your vehicle constantly turns slightly or “pulls” to one side when traveling on smooth, level road.
- When stopping, listen and check for unusual sounds, pulling to one side, increased brake pedal travel or “hard-to-push” brake pedal.
- If any slipping or changes in the operation of your transaxle occurs, check the transaxle fluid level.
- Check the automatic transaxle P (Park) function.
- Check the parking brake.
- Check for fluid leaks under your vehicle (water dripping from the air conditioning system during or after use is normal).

FarmaSOS.com

At least monthly:

- Check the coolant level in the engine coolant reservoir.
- Check the operation of all exterior lights, including the stoplights, turn signals and hazard warning flashers.
- Check the inflation pressures of all tires including the spare.

***At least twice a year
(i.e., every Spring and Fall) :***

- Check the radiator, heater and air conditioning hoses for leaks or damage.
- Check the windshield washer spray and wiper operation. Clean the wiper blades with clean cloth dampened with washer fluid.
- Check the headlight alignment.
- Check the muffler, exhaust pipes, shields and clamps.
- Check the lap/shoulder belts for wear and function.
- Check for worn tires and loose wheel lug nuts.

At least once a year :

- Clean the body and door drain holes.
- Lubricate the door hinges and check the hood hinges.
- Lubricate the door and hood locks and latches.
- Lubricate the door rubber weatherstrips.
- Check the air conditioning system.
- Check the power steering fluid level.
- Inspect and lubricate automatic transaxle linkage and controls.
- Clean the battery and terminals.
- Check the brake/clutch fluid level.

FarmaSOS.com

SCHEDULED MAINTENANCE SERVICE

Follow the Normal Maintenance Schedule if the vehicle is usually operated where none of the following conditions apply. If any of the following conditions apply, follow the Maintenance Under Severe Usage Conditions.

- Repeated short distance driving.
- Driving in dusty conditions or sandy areas.
- Extensive use of brakes.
- Driving in areas where salt or other corrosive materials are being used.
- Driving on rough or muddy roads.
- Driving in mountainous areas.
- Extended periods of idling or low speed operation.
- Driving for a prolonged period in cold temperatures and/or extremely humid climates.
- More than 50% driving in heavy city traffic during hot weather above 32°C (90°F).

If your vehicle is operated under the above conditions, you should inspect, replace or refill more frequently than the following Normal Maintenance Schedule. After 120 months or 240,000 km (150,000 miles) continue to follow the prescribed maintenance intervals.

امداد خودرو فارما

تلفن شبانه روزی: ۰۲۱-۸۸۸۶۲۰۸۵

FarmaSOS.com

NORMAL MAINTENANCE SCHEDULE

The following maintenance services must be performed to ensure good emission control and performance.

Keep receipts for all vehicle emission services to protect your warranty. Where both mileage and time are shown, the frequency of service is determined by whichever occurs first.

- *1 : Fuel filter & Fuel tank air filter are considered to be maintenance free but periodic inspection is recommended for this maintenance schedule depends on fuel quality. If there are some important safety matters like fuel flow restriction, surging, loss of power, hard starting problem etc, replace the fuel filter immediately regardless of maintenance schedule and consult an authorized Kia dealer for details.
- *2 : If TOP TIER Detergent Gasoline is not available, one bottle of additive is recommended. Additives are available from your authorized Kia dealer along with information on how to use them. Do not mix other additives.
- *3 : The drive belt should be replaced when cracks occur or tension is reduced excessively.

تلفن شبانه روزی: ۰۲۱-۸۸۸۶۲۰۸۵

FarmaSOS.com

NORMAL MAINTENANCE SCHEDULE

12,000 km (7,500 miles) or 6 months

- Rotate tire
- Inspect battery condition
- Inspect air cleaner filter
- Inspect vacuum hose
- Replace engine oil and filter
(12,000 km (7,500 miles) or 12 months)
- Add fuel additive *2
(12,000 km (7,500 miles) or 12 months)
- Inspect cooling system hoses and connections
- Inspect brake pedal free play

* Inspect : Inspect and if necessary, adjust, correct, clean or replace.

24,000 km (15,000 miles) or 12 months

- Rotate tire
- Inspect battery condition
- Inspect air cleaner filter
- Inspect vacuum hose
- Inspect air conditioning refrigerant
- Inspect brake hoses and lines
- Inspect drive shafts and boots
- Inspect exhaust pipe and muffler
- Inspect front brake disc/pads, calipers and rotors
- Inspect steering gear box, linkage & boots/lower arm ball joint, upper arm ball joint
- Inspect suspension mounting bolts
- Replace climate control air filter
(for evaporator and blower unit)
- Inspect rear brake disc/pads, parking brake
- Replace engine oil and filter
(24,000 km (15,000 miles) or 24 months)
- Add fuel additive *2
(12,000 km (7,500 miles) or 12 months)
- Inspect cooling system hoses and connections
- Inspect brake pedal free play
- Inspect all latch, hinges and locks

* Inspect : Inspect and if necessary, adjust, correct, clean or replace.

NORMAL MAINTENANCE SCHEDULE**36,000 km (22,500 miles) or 18 months**

- Rotate tire
- Inspect battery condition
- Inspect air cleaner filter
- Inspect vacuum hose
- Replace engine oil and filter
(36,000 km (22,500 miles) or 36 months)
- Add fuel additive *2
(12,000 km (7,500 miles) or 12 months)
- Inspect cooling system hoses and connections
- Inspect brake pedal free play

* Inspect : Inspect and if necessary, adjust, correct, clean or replace.

48,000 km (30,000 miles) or 24 months

- Rotate tire
- Inspect battery condition
- Inspect vacuum hose
- Inspect air conditioning refrigerant
- Inspect brake hoses and lines
- Inspect drive shafts and boots
- Inspect exhaust pipe and muffler
- Inspect front brake disc/pads, calipers and rotors
- Inspect steering gear box, linkage & boots/lower arm ball joint, upper arm ball joint
- Inspect suspension mounting bolts
- Inspect brake/clutch (if equipped) fluid
- Inspect fuel filter *1
- Inspect fuel lines, fuel hoses and connections
- Inspect fuel tank air filter (if equipped) *1
- Inspect rear brake disc/pads, parking brake
- Inspect vapor hose and fuel filler cap, fuel tank
- Replace climate control air filter
(for evaporator and blower unit)
- Replace air cleaner filter
- Replace engine oil and filter
(48,000 km (30,000 miles) or 48 months)

(Continued)

NORMAL MAINTENANCE SCHEDULE

(Continued)

- Add fuel additive *²
(12,000 km (7,500 miles) or 12 months)
- Inspect cooling system hoses and connections
- Inspect brake pedal free play
- Inspect all latch, hinges and locks

* Inspect : Inspect and if necessary, adjust, correct, clean or replace.

60,000 km (37,500 miles) or 30 months

- Rotate tire
- Inspect battery condition
- Inspect air cleaner filter
- Inspect vacuum hose
- Inspect manual transaxle fluid (if equipped)
- Replace engine oil and filter
(60,000 km (37,500 miles) or 60 months)
- Add fuel additive *²
(12,000 km (7,500 miles) or 12 months)
- Inspect cooling system hoses and connections
- Inspect brake pedal free play

* Inspect : Inspect and if necessary, adjust, correct, clean or replace.

72,000 km (45,000 miles) or 36 months

- Rotate tire
- Inspect battery condition
- Inspect air cleaner filter
- Inspect air conditioning refrigerant
- Inspect brake hoses and lines
- Inspect drive shafts and boots
- Inspect exhaust pipe and muffler
- Inspect front brake disc/pads, calipers and rotors
- Inspect steering gear box, linkage & boots/lower arm ball joint, upper arm ball joint
- Inspect suspension mounting bolts
- Inspect vacuum hose
- Replace climate control air filter
(for evaporator and blower unit)
- Inspect rear brake disc/pads, parking brake
- Replace engine oil and filter
(72,000 km (45,000 miles) or 72 months)
- Add fuel additive *²
(12,000 km (7,500 miles) or 12 months)
- Inspect cooling system hoses and connections
- Inspect brake pedal free play
- Inspect all latch, hinges and locks

* Inspect : Inspect and if necessary, adjust, correct, clean or replace.

NORMAL MAINTENANCE SCHEDULE

84,000 km (52,500 miles) or 42 months

- Rotate tire
- Inspect battery condition
- Inspect air cleaner filter
- Inspect vacuum hose
- Replace engine oil and filter
(84,000 km (52,500 miles) or 84 months)
- Add fuel additive *2
(12,000 km (7,500 miles) or 12 months)
- Inspect cooling system hoses and connections
- Inspect brake pedal free play

* Inspect : Inspect and if necessary, adjust, correct, clean or replace.

96,000 km (60,000 miles) or 48 months

- Rotate tire
- Inspect battery condition
- Inspect vacuum hose
- Inspect air conditioning refrigerant
- Inspect brake hoses and lines
- Inspect drive belts *3
(First, 96,000 km (60,000 miles) or 72 months
after every 24,000 km (15,000 miles) or 24 months)
- Inspect drive shafts and boots
- Inspect exhaust pipe and muffler
- Inspect front brake disc/pads, calipers and rotors
- Inspect steering gear box, linkage & boots/lower arm ball
joint, upper arm ball joint
- Inspect suspension mounting bolts
- Inspect brake/clutch (if equipped) fluid
- Inspect fuel filter *1
- Inspect fuel lines, fuel hoses and connections
- Inspect fuel tank air filter (if equipped) *1
- Inspect rear brake disc/pads, parking brake
- Inspect vapor hose and fuel filler cap, fuel tank

(Continued)

NORMAL MAINTENANCE SCHEDULE

(Continued)

- Replace climate control air filter
(for evaporator and blower unit)
- Replace air cleaner filter
- Replace engine oil and filter
(96,000 km (60,000 miles) or 96 months)
- Add fuel additive *²
(12,000 km (7,500 miles) or 12 months)
- Inspect cooling system hoses and connections
- Inspect brake pedal free play
- Inspect all latch, hinges and locks

* Inspect : Inspect and if necessary, adjust, correct, clean or replace.

108,000 km (67,500 miles) or 54 months

- Rotate tire
- Inspect battery condition
- Inspect air cleaner filter
- Inspect vacuum hose
- Replace engine oil and filter
(108,000 km (67,500 miles) or 108 months)
- Add fuel additive *²
(12,000 km (7,500 miles) or 12 months)
- Inspect cooling system hoses and connections
- Inspect brake pedal free play

* Inspect : Inspect and if necessary, adjust, correct, clean or replace.

FarmaSOS.com

NORMAL MAINTENANCE SCHEDULE

120,000 km (75,000 miles) or 60 months

- Rotate tire
- Inspect battery condition
- Inspect air cleaner filter
- Inspect air conditioning refrigerant
- Inspect brake hoses and lines
- Inspect drive belts *³
(First, 96,000 km (60,000 miles) or 72 months
after every 24,000 km (15,000 miles) or 24 months)
- Inspect drive shafts and boots
- Inspect exhaust pipe and muffler
- Inspect front brake disc/pads, calipers and rotors
- Inspect steering gear box, linkage & boots/lower arm ball
joint, upper arm ball joint
- Inspect suspension mounting bolts
- Inspect manual transaxle fluid (if equipped)
- Inspect vacuum hose
- Replace climate control air filter
(for evaporator and blower unit)
- Inspect rear brake disc/pads, parking brake
- Replace engine oil and filter
(120,000 km (75,000 miles) or 120 months)

(Continued)

(Continued)

- Add fuel additive *²
(12,000 km (7,500 miles) or 12 months)
- Inspect cooling system hoses and connections
- Inspect brake pedal free play
- Inspect all latch, hinges and locks

* Inspect : Inspect and if necessary, adjust, correct, clean or replace.

NORMAL MAINTENANCE SCHEDULE

132,000 km (82,500 miles) or 66 months

- Rotate tire
- Inspect battery condition
- Inspect air cleaner filter
- Inspect vacuum hose
- Replace engine oil and filter
(132,000 km (82,500 miles) or 132 months)
- Add fuel additive *2
(12,000 km (7,500 miles) or 12 months)
- Inspect cooling system hoses and connections
- Inspect brake pedal free play

* Inspect : Inspect and if necessary, adjust, correct, clean or replace.

144,000 km (90,000 miles) or 72 months

- Rotate tire
- Inspect battery condition
- Inspect air conditioning refrigerant
- Inspect brake hoses and lines
- Inspect drive belts *3
(First, 96,000 km (60,000 miles) or 72 months
after every 24,000 km (15,000 miles) or 24 months)
- Inspect drive shafts and boots
- Inspect exhaust pipe and muffler
- Inspect front brake disc/pads, calipers and rotors
- Inspect steering gear box, linkage & boots/lower arm ball joint, upper arm ball joint
- Inspect suspension mounting bolts
- Inspect brake/clutch (if equipped) fluid
- Inspect fuel filter *1
- Inspect fuel lines, fuel hoses and connections
- Inspect fuel tank air filter (if equipped) *1
- Inspect rear brake disc/pads, parking brake
- Inspect vapor hose and fuel filler cap, fuel tank
- Inspect vacuum hose
- Replace climate control air filter
(for evaporator and blower unit)

(Continued)

NORMAL MAINTENANCE SCHEDULE

(Continued)

- Replace air cleaner filter
- Replace engine oil and filter
(144,000 km (90,000 miles) or 144 months)
- Add fuel additive *²
(12,000 km (7,500 miles) or 12 months)
- Inspect cooling system hoses and connections
- Inspect brake pedal free play
- Inspect all latch, hinges and locks

* Inspect : Inspect and if necessary, adjust, correct, clean or replace.

156,000 km (97,500 miles) or 78 months

- Rotate tire
- Inspect battery condition
- Inspect air cleaner filter
- Inspect vacuum hose
- Replace engine oil and filter
(156,000 km (97,500 miles) or 156 months)
- Add fuel additive *²
(12,000 km (7,500 miles) or 12 months)
- Inspect cooling system hoses and connections
- Inspect brake pedal free play

* Inspect : Inspect and if necessary, adjust, correct, clean or replace.

FarmaSOS.com

NORMAL MAINTENANCE SCHEDULE

168,000 km (105,000 miles) or 84 months

- Rotate tire
- Inspect battery condition
- Inspect air cleaner filter
- Inspect air conditioning refrigerant
- Inspect brake hoses and lines
- Inspect drive belts *³
(First, 96,000 km (60,000 miles) or 72 months
after every 24,000 km (15,000 miles) or 24 months)
- Inspect drive shafts and boots
- Inspect exhaust pipe and muffler
- Inspect front brake disc/pads, calipers and rotors
- Inspect steering gear box, linkage & boots/lower arm ball
joint, upper arm ball joint
- Inspect suspension mounting bolts
- Inspect vacuum hose
- Replace climate control air filter
(for evaporator and blower unit)
- Inspect rear brake disc/pads, parking brake
- Replace spark plugs (iridium coated)
- Replace engine oil and filter
(168,000 km (105,000 miles) or 168 months)

(Continued)

(Continued)

- Add fuel additive *²
(12,000 km (7,500 miles) or 12 months)
- Inspect cooling system hoses and connections
- Inspect brake pedal free play
- Inspect all latch, hinges and locks

* Inspect : Inspect and if necessary, adjust, correct, clean or replace.

NORMAL MAINTENANCE SCHEDULE

180,000 km (112,500 miles) or 90 months

- Rotate tire
- Inspect battery condition
- Inspect air cleaner filter
- Inspect manual transaxle fluid (if equipped)
- Inspect vacuum hose
- Replace engine oil and filter
(180,000 km (112,500 miles) or 180 months)
- Add fuel additive *²
(12,000 km (7,500 miles) or 12 months)
- Inspect cooling system hoses and connections
- Inspect brake pedal free play

* Inspect : Inspect and if necessary, adjust, correct, clean or replace.

192,000 km (120,000 miles) or 96 months

- Rotate tire
- Inspect battery condition
- Inspect air conditioning refrigerant
- Inspect brake hoses and lines
- Inspect drive belts *³
(First, 96,000 km (60,000 miles) or 72 months
after every 24,000 km (15,000 miles) or 24 months)
- Inspect drive shafts and boots
- Inspect exhaust pipe and muffler
- Inspect rear brake disc/pads, parking brake
- Inspect steering gear box, linkage & boots/lower arm ball joint, upper arm ball joint
- Inspect suspension mounting bolts
- Inspect brake/clutch (if equipped) fluid
- Inspect fuel filter *¹
- Inspect fuel lines, fuel hoses and connections
- Inspect fuel tank air filter (if equipped) *¹
- Inspect front brake disc/pads, calipers and rotors
- Inspect vacuum hose
- Inspect vapor hose and fuel filler cap, fuel tank
- Replace climate control air filter
(for evaporator and blower unit)

(Continued)

NORMAL MAINTENANCE SCHEDULE

(Continued)

- Replace air cleaner filter
- Replace engine oil and filter
(192,000 km (120,000 miles) or 192 months)
- Replace coolant
(First, 192,000 km (120,000 miles) or 120 months
after every 48,000 km (30,000 miles) or 24 months)
- Add fuel additive *²
(12,000 km (7,500 miles) or 12 months)
- Inspect cooling system hoses and connections
- Inspect brake pedal free play
- Inspect all latch, hinges and locks

* Inspect : Inspect and if necessary, adjust, correct, clean or replace.

204,000 km (127,500 miles) or 102 months

- Rotate tire
- Inspect battery condition
- Inspect air cleaner filter
- Inspect vacuum hose
- Replace engine oil and filter
(204,000 km (127,500 miles) or 204 months)
- Add fuel additive *²
(12,000 km (7,500 miles) or 12 months)
- Inspect cooling system hoses and connections
- Inspect brake pedal free play

* Inspect : Inspect and if necessary, adjust, correct, clean or replace.

FarmaSOS.com

NORMAL MAINTENANCE SCHEDULE**216,000 km (135,000 miles) or 108 months**

- Rotate tire
- Inspect battery condition
- Inspect air cleaner filter
- Inspect air conditioning refrigerant
- Inspect brake hoses and lines
- Inspect drive belts *3
 - (First, 96,000 km (60,000 miles) or 72 months
 - after every 24,000 km (15,000 miles) or 24 months)
- Inspect drive shafts and boots
- Inspect exhaust pipe and muffler
- Inspect rear brake disc/pads, parking brake
- Inspect steering gear box, linkage & boots/lower arm ball joint, upper arm ball joint
- Inspect suspension mounting bolts
- Inspect vacuum hose
- Replace climate control air filter (for evaporator and blower unit)
- Inspect front brake disc/pads, calipers and rotors
- Replace engine oil and filter (216,000 km (135,000 miles) or 216 months)
- Add fuel additive *2 (12,000 km (7,500 miles) or 12 months)

(Continued)

(Continued)

- Inspect cooling system hoses and connections
- Inspect brake pedal free play
- Inspect all latch, hinges and locks

* Inspect : Inspect and if necessary, adjust, correct, clean or replace.

228,000 km (142,500 miles) or 114 months

- Rotate tire
- Inspect battery condition
- Inspect air cleaner filter
- Inspect vacuum hose
- Replace engine oil and filter (228,000 km (142,500 miles) or 228 months)
- Add fuel additive *2 (12,000 km (7,500 miles) or 12 months)
- Inspect cooling system hoses and connections
- Inspect brake pedal free play

* Inspect : Inspect and if necessary, adjust, correct, clean or replace.

NORMAL MAINTENANCE SCHEDULE

240,000 km (150,000 miles) or 120 months

- Rotate tire
- Inspect battery condition
- Inspect air conditioning refrigerant
- Inspect brake hoses and lines
- Inspect drive belts *3
(First, 96,000 km (60,000 miles) or 72 months
after every 24,000 km (15,000 miles) or 24 months)
- Inspect drive shafts and boots
- Inspect exhaust pipe and muffler
- Inspect front brake disc/pads, calipers and rotors
- Inspect steering gear box, linkage & boots/lower arm ball joint, upper arm ball joint
- Inspect suspension mounting bolts
- Inspect brake/clutch (if equipped) fluid
- Inspect fuel filter *1
- Inspect fuel lines, fuel hoses and connections
- Inspect fuel tank air filter (if equipped) *1
- Inspect rear brake disc/pads, parking brake
- Inspect vapor hose and fuel filler cap, fuel tank
- Inspect vacuum hose
- Inspect manual transaxle fluid (if equipped)

(Continued)

(Continued)

- Replace climate control air filter
(for evaporator and blower unit)
- Replace air cleaner filter
- Replace engine oil and filter
(240,000 km (150,000 miles) or 240 months)
- Replace coolant
(First, 192,000 km (120,000 miles) or 120 months
after every 48,000 km (30,000 miles) or 24 months)
- Add fuel additive *2
(12,000 km (7,500 miles) or 12 months)
- Inspect cooling system hoses and connections
- Inspect brake pedal free play
- Inspect all latch, hinges and locks

* Inspect : Inspect and if necessary, adjust, correct, clean or replace.

No check, No service required

- Automatic transaxle fluid (if equipped)

MAINTENANCE UNDER SEVERE USAGE CONDITIONS

The following items must be serviced more frequently on cars normally used under severe driving conditions. Refer to the chart below for the appropriate maintenance intervals.

R : Replace I : Inspect and, after inspection, clean, adjust, repair or replace if necessary

MAINTENANCE ITEM	MAINTENANCE OPERATION	MAINTENANCE INTERVALS	DRIVING CONDITION
ENGINE OIL AND FILTER	R	EVERY 6,000 KM (3,750 MILES) OR 6 MONTHS	A, B, C, D, E, F, G, H, I, J, K
AIR CLEANER FILTER	R	MORE FREQUENTLY	C, E
SPARK PLUGS	R	MORE FREQUENTLY	B, H
AUTOMATIC TRANSAXLE FLUID	R	EVERY 96,000 KM (60,000 MILES)	A, C, E, F, G, I
MANUAL TRANSAXLE FLUID	R	EVERY 120,000 KM (75,000 MILES)	A, C, E, F, G, I

FarmaSOS.com

(Continued)

Maintenance

MAINTENANCE ITEM	MAINTENANCE OPERATION	MAINTENANCE INTERVALS	DRIVING CONDITION
FRONT DISC BRAKE/PADS, CALIPERS AND ROTORS	I	MORE FREQUENTLY	C, D, G, H
REAR DISC BRAKE/PADS, PARKING BRAKE	I	MORE FREQUENTLY	C, D, G, H
STEERING GEAR BOX, LINKAGE & BOOTS/LOWER ARM BALL JOINT, UPPER ARM BALL JOINT	I	MORE FREQUENTLY	C, D, E, F, G, H, I
DRIVE SHAFTS AND BOOTS	I	EVERY 120,000 KM (75,000 MILES) OR 6 MONTHS	C, D, E, F, G, H, I, J
CLIMATE CONTROL AIR FILTER (FOR EVAPORATOR AND BLOWER UNIT)	R	MORE FREQUENTLY	C, E

SEVERE DRIVING CONDITIONS

- تلفن شبانه روزی: ۰۲۱-۸۸۶۲۰۸۵
- FarmaSO3.com
- A - Repeatedly driving short distance of less than 8 km (5 miles) in normal temperature or less than 16 km (10 miles) in freezing temperature
 - B - Extensive engine idling or low speed driving for long distances
 - C - Driving on rough, dusty, muddy, unpaved, graveled or salt-spread roads
 - D - Driving in areas using salt or other corrosive materials or in very cold weather
 - E - Driving in sandy areas
 - F - Driving in heavy traffic area over 32°C (90°F)
 - G - Driving on uphill, downhill, or mountain road
 - H - Towing a Trailer, or using a camper, or roof rack
 - I - Driving as a patrol car, taxi, other commercial use or vehicle towing
 - J - Driving over 170 km/h (106 mph)
 - K - Frequently driving in stop-and-go conditions

EXPLANATION OF SCHEDULED MAINTENANCE ITEMS

Engine oil and filter

The engine oil and filter should be changed at the intervals specified in the maintenance schedule. If the car is being driven in severe conditions, more frequent oil and filter changes are required.

Drive belts

Inspect all drive belts for evidence of cuts, cracks, excessive wear or oil saturation and replace if necessary. Drive belts should be checked periodically for proper tension and adjusted as necessary.

Fuel filter

A clogged filter can limit the speed at which the vehicle may be driven, damage the emission system and cause multiple issues such as hard starting. If an excessive amount of foreign matter accumulates in the fuel tank, the filter may require replacement more frequently.

After installing a new filter, run the engine for several minutes, and check for leaks at the connections. Fuel filters should be installed by an authorized Kia dealer.

تلفن شبانه روزی: ۰۲۱-۸۸۸۶۲۰۸۵

FarmaSOS.com

Fuel lines, fuel hoses and connections

Check the fuel lines, fuel hoses and connections for leakage and damage. Have an authorized Kia dealer replace any damaged or leaking parts immediately.

Vapor hose and fuel filler cap

The vapor hose and fuel filler cap should be inspected at those intervals specified in the maintenance schedule. Make sure that a new vapor hose or fuel filler cap is correctly replaced.

Vacuum crankcase ventilation hoses

Inspect the surface of hoses for evidence of heat and/or mechanical damage. Hard and brittle rubber, cracking, tears, cuts, abrasions, and excessive swelling indicate deterioration. Particular attention should be paid to examine those hose surfaces nearest to high heat sources, such as the exhaust manifold.

Inspect the hose routing to assure that the hoses do not come in contact with any heat source, sharp edges or moving component which might cause heat damage or mechanical wear. Inspect all hose connections, such as clamps and couplings, to make sure they are secure, and that no leaks are present. Hoses should be replaced immediately if there is any evidence of deterioration or damage.

Air cleaner filter

A Genuine Kia air cleaner filter is recommended when the filter is replaced.

Spark plugs

Make sure to install new spark plugs of the correct heat range.

Cooling system

Check cooling system components, such as radiator, coolant reservoir, hoses and connections for leakage and damage. Replace any damaged parts.

Coolant

The coolant should be changed at the intervals specified in the maintenance schedule.

Manual transaxle fluid (if equipped)

Inspect the manual transaxle fluid according to the maintenance schedule.

FarmaSOS.com

Automatic transaxle fluid (if equipped)

Automatic transaxle fluid should not be checked under normal usage conditions.

But in severe conditions, the fluid should be changed at an authorized Kia dealer in accordance to the scheduled maintenance at the beginning of this chapter.

*** NOTICE**

Automatic transaxle fluid color is basically red.

As the vehicle is driven, the automatic transaxle fluid will begin to look darker.

It is normal condition and you should not judge the need to replace the fluid based upon the changed color.

Brake hoses and lines

Visually check for proper installation, chafing, cracks, deterioration and any leakage. Replace any deteriorated or damaged parts immediately.

Brake/clutch fluid

Check brake fluid level in the brake fluid reservoir. The level should be between "MIN" and "MAX" marks on the side of the reservoir. Use only hydraulic brake fluid conforming to DOT 3 or DOT 4 specification.

تلفن شبانه روزی: ۰۲۱-۸۸۸۶۲۰۸۵

FarmaSOS.com

Parking brake

Inspect the parking brake system including the parking brake pedal and cables.

Brake discs, pads, calipers and rotors

Check the pads for excessive wear, discs for run out and wear, and calipers for fluid leakage.

Exhaust pipe and muffler

Visually inspect the exhaust pipes, muffler and hangers for cracks, deterioration, or damage. Start the engine and listen carefully for any exhaust gas leakage. Tighten connections or replace parts as necessary.

Suspension mounting bolts

Check the suspension connections for looseness or damage. Retighten to the specified torque.

Steering gear box, linkage & boots/lower arm ball joint

With the vehicle stopped and engine off, check for excessive free-play in the steering wheel.

Check the linkage for bends or damage. Check the dust boots and ball joints for deterioration, cracks, or damage. Replace any damaged parts.

Drive shafts and boots

Check the drive shafts, boots and clamps for cracks, deterioration, or damage. Replace any damaged parts and, if necessary, repack the grease.

Air conditioning refrigerant

Check the air conditioning lines and connections for leakage and damage.

FarmaSOS.com

ENGINE OIL

Checking the engine oil level

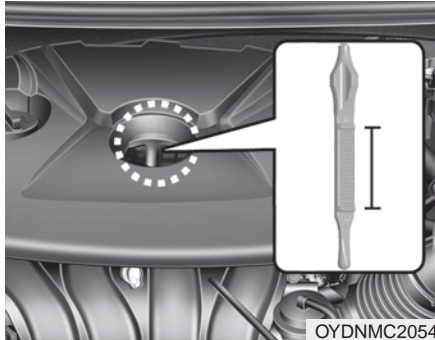

1. Be sure the vehicle is on level ground.
2. Start the engine and allow it to reach normal operating temperature.
3. Turn the engine off and wait for a few minutes (about 5 minutes) for the oil to return to the oil pan.
4. Pull the dipstick out, wipe it clean, and reinsert it fully.

⚠ WARNING - Radiator hose

Be very careful not to touch the radiator hose when checking or adding the engine oil as it may be hot enough to burn you.

5. Pull the dipstick out again and check the level. The level should be between F and L.

⚠ CAUTION - Replace engine oil

Do not overfill with engine oil. Engine damage may result.

FarmaSOS.com

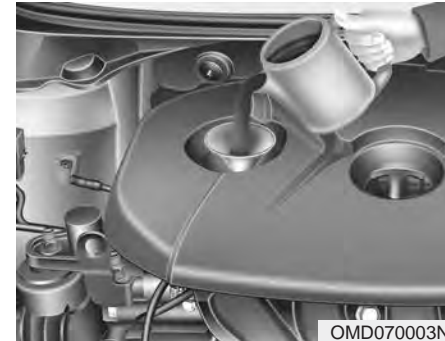

If it is near or at L, add enough oil to bring the level to F. **Do not overfill.**

Use a funnel to help prevent oil from being spilled on engine components.

Use only the specified engine oil. (Refer to "Recommended lubricants and capacities" in section 8.)

Changing the engine oil and filter

Have engine oil and filter changed by an authorized Kia dealer according to the Maintenance Schedule at the beginning of this chapter.

⚠ WARNING

Used engine oil may cause irritation or cancer of the skin if left in contact with the skin for prolonged periods of time. Always protect your skin by washing your hands thoroughly with soap and warm water as soon as possible after handling used oil.

امداد خودرو فارما

تلفن شبانه روزی: ۰۲۱-۸۸۸۶۲۰۸۵

FarmaSOS.com

ENGINE COOLANT

The high-pressure cooling system has a reservoir filled with year-round antifreeze coolant. The reservoir is filled at the factory.

Check the antifreeze protection and coolant level at least once a year, at the beginning of the winter season, and before traveling to a colder climate.

⚠ WARNING - Cooling fan



Use caution when working near the blade of the cooling fan. The electric motor (cooling fan) is controlled by engine coolant temperature, refrigerant pressure and vehicle speed. It may sometimes operate even when the engine is not running.

Checking the coolant level

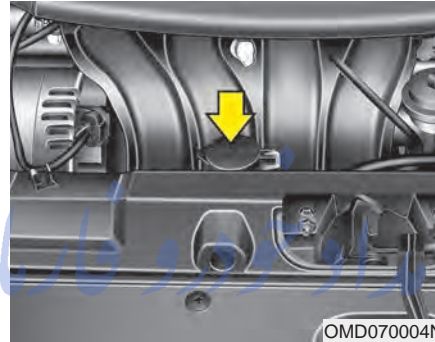

Check the condition and connections of all cooling system hoses and heater hoses. Replace any swollen or deteriorated hoses.

The coolant level should be filled between F (MAX) and L (MIN) marks on the side of the coolant reservoir when the engine is cool.

If the coolant level is low, add enough specified coolant or distilled (deionized) water to provide protection against freezing and corrosion. Bring the level to F (MAX), but do not overfill. If frequent coolant addition is required, see an authorized Kia dealer for a cooling system inspection.

Recommended engine coolant

- When adding coolant, use only deionized water or soft water for your vehicle and never mix hard water in the coolant filled at the factory. An improper coolant mixture can result in serious malfunction or engine damage.
- The engine in your vehicle has aluminum engine parts and must be protected by an ethylene-glycol-based coolant to prevent corrosion and freezing.
- **DO NOT USE** alcohol or methanol coolant or mix them with the specified coolant.
- Do not use a solution that contains more than 60% antifreeze or less than 35% antifreeze, which would reduce the effectiveness of the solution.

For mixture percentage, refer to the following table.

Ambient Temperature	Mixture Percentage (volume)	
	Antifreeze	Water
-15°C (5°F)	35	65
-25°C (-13°F)	40	60
-35°C (-31°F)	50	50
-45°C (-49°F)	60	40

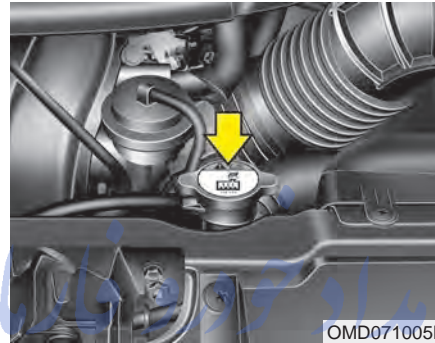

CAUTION - Removing radiator cap



Never attempt to remove the radiator cap while the engine is operating or hot. Doing so might lead to cooling system and engine damage.

WARNING



Radiator cap

Do not remove the radiator cap when the engine and radiator are hot. Scalding hot coolant and steam may blow out under pressure.

Turn the engine off and wait until it cools down. Use care when removing the radiator cap. Wrap a thick towel around it, and turn it counterclockwise slowly to the first stop. Step back while the pressure is released from the cooling system. When you are sure all the pressure has been released, press down on the cap, using a thick towel, and continue turning counterclockwise to remove it.

Changing the coolant

Have the coolant changed by an authorized Kia dealer according to the Maintenance Schedule at the beginning of this section.

امداد خودرو فارما

تلفن شبانه روزی: ۰۲۱-۸۸۸۶۲۰۸۵

FarmaSOS.com

BRAKE/CLUTCH (IF EQUIPPED) FLUID

Checking the brake/clutch* fluid level

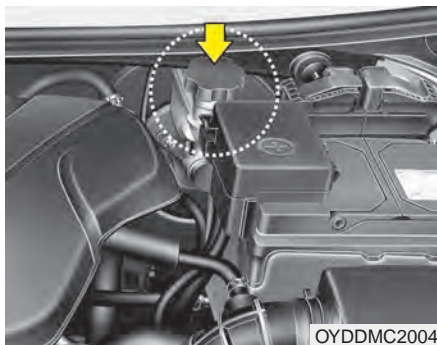

Check the fluid level in the reservoir periodically. The fluid level should be between MAX and MIN marks on the side of the reservoir.

Before removing the reservoir cap and adding brake/clutch* fluid, clean the area around the reservoir cap thoroughly to prevent brake/clutch* fluid contamination.

* if equipped

⚠ CAUTION - Proper fluid
Only use brake/clutch fluid in brake/clutch system. Small amounts of improper fluids (such as engine oil) can cause damage to the brake/clutch system.

If the level is low, add fluid to the MAX level. The level will fall with accumulated mileage. This is a normal condition associated with the wear of the brake linings and/or clutch disc (if equipped). If the fluid level is excessively low, have the brake/clutch* system checked by an authorized Kia dealer.

Use only the specified brake/clutch fluid. (Refer to "Recommended lubricants and capacities" in chapter 8.)*

Never mix different types of fluid.

In the event the brake/clutch* system requires frequent additions of fluid, the vehicle should be inspected by an authorized Kia dealer.

When changing and adding brake/clutch* fluid, handle it carefully. Do not let it come in contact with your eyes. If brake/clutch* fluid should come in contact with your eyes, immediately flush them with a large quantity of fresh tap water. Have your eyes examined by a doctor as soon as possible.

⚠ CAUTION - Brake/clutch fluid
Do not allow brake/clutch fluid to contact the vehicle's body paint, as paint damage will result.*

Brake/clutch* fluid, which has been exposed to open air for an extended time should never be used as its quality cannot be guaranteed. It should be disposed of properly.

WASHER FLUID

Checking the washer fluid level

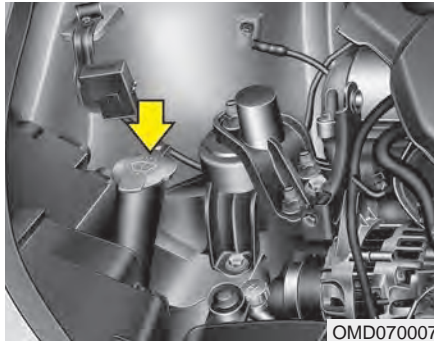

OMD070007

Check the fluid level in the washer fluid reservoir and add fluid if necessary. Plain water may be used if washer fluid is not available. However, use washer solvent with antifreeze characteristics in cold climates to prevent freezing.

⚠ WARNING - Windshield fluid

Do not drink the windshield washer fluid. The windshield washer fluid is poisonous to humans and animals.

⚠ WARNING - Flammable fluid

Do not allow the washer fluid to come in contact with open flames or sparks. The windshield washer fluid reservoir is flammable under certain circumstances. This can result in a fire.

PARKING BRAKE

Checking the parking brake

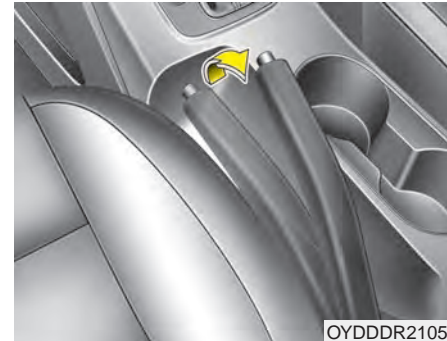

OYDDDR2105

Check the stroke of the parking brake by counting the number of “clicks” heard while fully applying it from the released position. Also, the parking brake alone should securely hold the vehicle on a fairly steep grade. If the stroke is more or less than specified, have the parking brake adjusted by an authorized Kia dealer.

Stroke : 6~8 “clicks” at a force of 20 kg (44 lbs, 196 N).

AIR CLEANER

Filter replacement

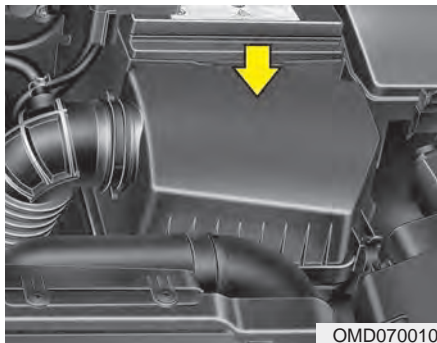

It must be replaced when necessary, and should not be washed.

You can clean the filter when inspecting the air cleaner element.

Clean the filter by using compressed air.

Replace the filter according to the Maintenance Schedule.

If the vehicle is operated in extremely dusty or sandy areas, replace the element more often than the usual recommended intervals. (Refer to "Maintenance under severe usage conditions" in this chapter.)

امداد خودرو فارما

تلفن شبانه روزی: ۰۲۱-۸۸۸۶۲۰۸۵

FarmaSOS.com

CAUTION - Air filter maintenance

- **Do not drive with the air cleaner removed; this will result in excessive engine wear.**
- **When removing the air cleaner filter, be careful that dust or dirt does not enter the air intake, or damage may result.**
- **Use a Kia genuine part. Use of nongenuine part could damage the air flow sensor.**

CLIMATE CONTROL AIR FILTER (IF EQUIPPED)

Filter inspection

The climate control air filter should be replaced according to the Maintenance Schedule. If the vehicle is operated in severely air-polluted cities or on dusty rough roads for a long period, it should be inspected more frequently and replaced earlier. When you replace the climate control air filter, replace it performing the following procedure, and be careful to avoid damaging other components.

امداد خودرو فارما

تلفن شبانه روزی: ۰۲۱-۸۸۸۶۲۰۸۵

FarmaSOS.com

WIPER BLADES

Blade inspection

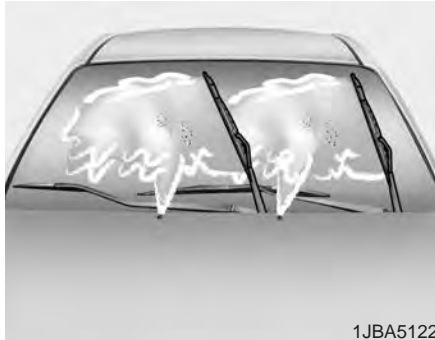

Commercial hot waxes applied by automatic car washes have been known to make the windshield difficult to clean.

Contamination of either the windshield or the wiper blades with foreign matter can reduce the effectiveness of the windshield wipers. Common sources of contamination are insects, tree sap, and hot wax treatments used by some commercial car washes. If the blades are not wiping properly, clean both the window and the blades with a good cleaner or mild detergent, and rinse thoroughly with clean water.

CAUTION - Wiper blades

To prevent damage to the wiper blades, do not use gasoline, kerosene, paint thinner, or other solvents on or near them.

Blade replacement

When the wipers no longer clean adequately, the blades may be worn or cracked, and require replacement.

To prevent damage to the wiper arms or other components, do not attempt to move the wipers manually.

The use of a non-specified wiper blade could result in wiper malfunction and failure.

FarmaSOS.com

Front windshield wiper blade

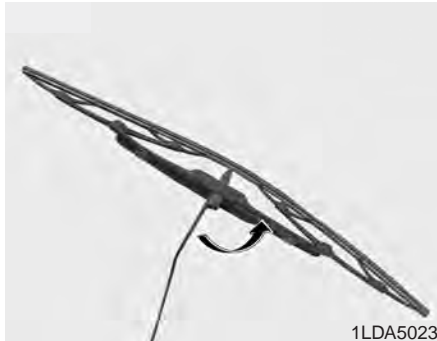

Type A

⚠ CAUTION - Wiper arms

Do not allow the wiper arm to fall against the windshield, since it may chip or crack the windshield.

1. Raise the wiper arm and turn the wiper blade assembly to expose the plastic locking clip.

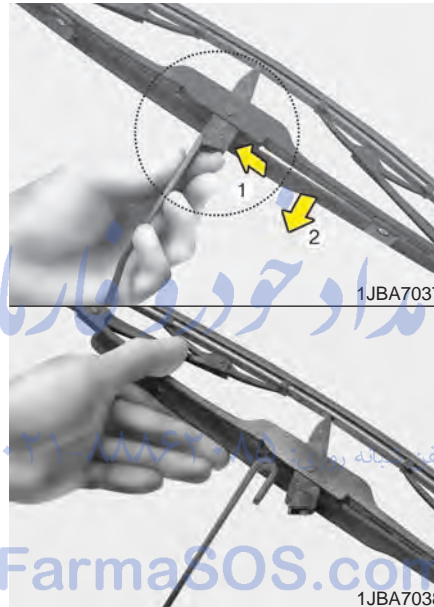

2. Compress the clip (1) and slide the blade assembly downward (2).
3. Lift it off the arm.
4. Install the blade assembly in the reverse order of removal.



Type B

1. Raise the wiper arm.

⚠ CAUTION

Do not allow the wiper arm to fall against the windshield, since it may chip or crack the windscreen.

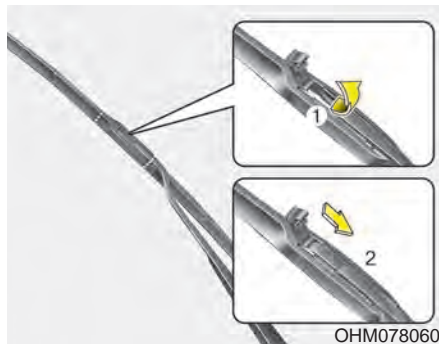

2. Lift up the wiper blade clip. Then pull down the blade assembly and remove it.



3. Install the new blade assembly in the reverse order of removal.

تلفن شبانه روزی: ۰۲۱-۸۸۸۶۲۰۸۵

FarmaSOS.com

BATTERY

For best battery service

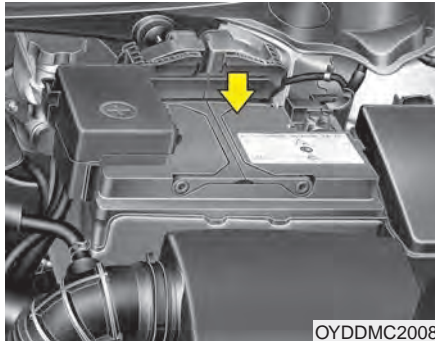

- Keep the battery securely mounted.
- Keep the battery top clean and dry.
- Keep the terminals and connections clean, tight, and coated with petroleum jelly or terminal grease.
- Rinse any spilled electrolyte from the battery immediately with a solution of water and baking soda.
- If the vehicle is not going to be used for an extended time, disconnect the battery cables.

⚠ WARNING - Risk of explosion



Keep lit cigarettes and all other flames or sparks away from the battery.



The battery contains hydrogen -- a highly combustible gas which will explode if it comes in contact with a flame or spark.

تلفن شبانه روزی: ۰۲۱-۸۸۶۲۰۸۵

FarmaSOS.com

⚠ WARNING - Sulfuric acid in batteries



Keep batteries out of the reach of children because batteries contain highly corrosive **SULFURIC ACID** and electrolytes. Do not allow battery acid to contact your skin, eyes, clothing or paint finish.



Wear eye protection when charging or working near a battery. Always provide ventilation when working in an enclosed space.



Always read the following instructions carefully when handling a battery.



If any electrolyte gets into your eyes, flush your eyes with clean water for at least 15 minutes and get immediate medical attention.

If electrolyte gets on your skin, thoroughly wash the contacted area. If you feel pain or burning sensation, get medical attention immediately.



An inappropriately disposed battery can be harmful to the environment and human health. Dispose the battery according to your local law(s) or regulation.



The battery contains lead. Do not dispose of it after use. Please return the battery to an authorized Kia dealer to be recycled.

⚠ WARNING - Recharging battery

Never attempt to recharge the battery when the battery cables are connected.

When the vehicle remains unused for a long time while temperatures are low, disconnect the battery and keep it indoors.

تلفن شبانه روزی: ۰۲۱-۸۸۶۲۰۸۵

FarmaSOS.com

⚠ WARNING - Risk of electrocution

Never touch the electrical ignition system while the vehicle is running. This system works with high voltage which can "zap" you.

Battery recharging

Your vehicle has a maintenance-free, calcium-based battery.

- If the battery becomes discharged in a short time (because, for example, the headlights or interior lights were left on while the vehicle was not in use), recharge it by slow charging (trickle) for 10 hours.
- If the battery gradually discharges because of high electric load while the vehicle is being used, recharge it at 20-30A for two hours.

When recharging the battery, observe the following precautions:

- The battery must be removed from the vehicle and placed in an area with good ventilation.
- Watch the battery during charging, and stop or reduce the charging rate if the battery cells begin gassing (boiling) violently or if the temperature of the electrolyte of any cell exceeds 49°C (120°F).
- Wear eye protection when checking the battery during charging.
- Disconnect the battery charger in the following order.
 1. Turn off the battery charger main switch.
 2. Unhook the negative clamp from the negative battery terminal.
 3. Unhook the positive clamp from the positive battery terminal.
- Before performing maintenance or recharging the battery, turn off all accessories and stop the engine.
- The negative battery cable must be removed first and installed last when the battery is disconnected.

Reset items

Items should be reset after the battery has been discharged or the battery has been disconnected.

- Auto down window (See chapter 4)
- Sunroof (See chapter 4)
- Trip computer (See chapter 4)
- Climate control system (See chapter 4)
- Clock (See chapter 4)
- Audio (See chapter 4)

TIRES AND WHEELS

Tire care

For proper maintenance, safety, and maximum fuel economy, you must always maintain recommended tire inflation pressures and stay within the load limits and weight distribution recommended for your vehicle.

Recommended cold tire inflation pressures

All tire pressures (including the spare) should be checked when the tires are cold. "Cold Tires" means the vehicle has not been driven for at least three hours or driven less than 1.6 km (one mile).

Recommended pressures must be maintained for the best ride, top vehicle handling, and minimum tire wear.

For recommended inflation pressure refer to "Tire and wheels" in section 8.

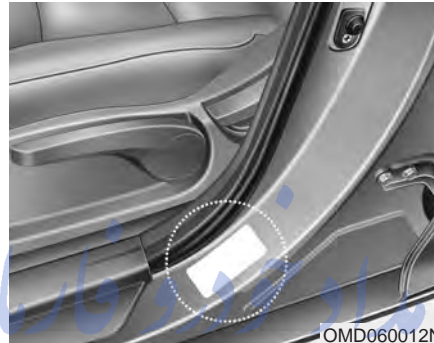

All specifications (sizes and pressures) can be found on a label attached to the driver's side center pillar. — ۸۸۶۲۰۸۵ تلفن شبانه روزی: —

⚠ WARNING - Tire underinflation

Inflate your tires consistent with the instructions provided in this manual. Severe underinflation (70 kPa (10 psi) or more) can lead to severe heat build-up, causing blowouts, tread separation and other tire failures that can result in the loss of vehicle control. This risk is much higher on hot days and when driving for long periods at high speeds.

FarmaSOS.com

- Underinflation also results in excessive wear, poor handling and reduced fuel economy. Wheel deformation also is possible. Keep your tire pressures at the proper levels. If a tire frequently needs refilling, have it checked by an authorized Kia dealer.
- Overinflation produces a harsh ride, excessive wear at the center of the tire tread, and a greater possibility of damage from road hazards.
- Warm tires normally exceed recommended cold tire pressures by 28 to 41 kPa (4 to 6 psi). Do not release air from warm tires to adjust the pressure or the tires will be underinflated.
- Be sure to reinstall the tire inflation valve caps. Without the valve cap, dirt or moisture could get into the valve core and cause air leakage. If a valve cap is missing, install a new one as soon as possible.

Always observe the following:

- Check tire pressure when the tires are cold. (After vehicle has been parked for at least three hours or hasn't been driven more than 1.6 km (one mile) since startup.)
- Check the pressure of your spare tire each time you check the pressure of other tires.
- Never overload your vehicle. Be careful not to overload a vehicle luggage rack if your vehicle is equipped with one.

تلفن شبانه روزی: ۰۲۱-۸۸۸۶۲۰۸۵

FarmaSOS.com

Checking tire inflation pressure

Check your tires once a month or more.

Also, check the tire pressure of the spare tire.

How to check

Use a good quality gauge to check tire pressure. You can not tell if your tires are properly inflated simply by looking at them. Radial tires may look properly inflated even when they're underinflated.

Check the tire's inflation pressure when the tires are cold. - "Cold" means your vehicle has been sitting for at least three hours or driven no more than 1.6 km (1 mile).

Remove the valve cap from the tire valve stem. Press the tire gauge firmly onto the valve to get a pressure measurement. If the cold tire inflation pressure matches the recommended pressure on the tire and loading information label, no further adjustment is necessary. If the pressure is low, add air until you reach the recommended amount.

If you overfill the tire, release air by pushing on the metal stem in the center of the tire valve. Recheck the tire pressure with the tire gauge. Be sure to put the valve caps back on the valve stems. They help prevent leaks by keeping out dirt and moisture.

- Inspect your tires frequently for proper inflation as well as wear and damage. Always use a tire pressure gauge.
- Tires with too much or too little pressure wear unevenly causing poor handling, loss of vehicle control, and sudden tire failure leading to accidents, injuries, and even death. The recommended cold tire pressure for your vehicle can be found in this manual and on the tire label located on the driver's side center pillar.
- Remember to check the pressure of your spare tire. Kia recommends that you check the spare every time you check the pressure of the other tires on your vehicle.

Tire rotation

To equalize tread wear, it is recommended that the tires be rotated every 12,000 km (7,500 miles) or sooner if irregular wear develops.

During rotation, check the tires for correct balance.

When rotating tires, check for uneven wear and damage. Abnormal wear is usually caused by incorrect tire pressure, improper wheel alignment, out-of-balance wheels, severe braking or severe cornering. Look for bumps or bulges in the tread or side of tire. Replace the tire if you find either of these conditions. Replace the tire if fabric or cord is visible. After rotation, be sure to bring the front and rear tire pressures to specification and check lug nut tightness.

Refer to "Tire and wheels" in chapter 8.

Without a spare tire

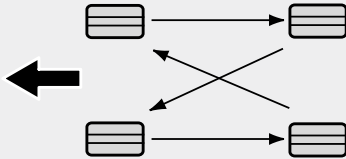

S2BLA790A

Directional tires (if equipped)

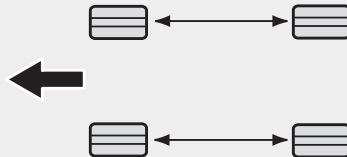

CBGQ0707A

Disc brake pads should be inspected for wear whenever tires are rotated.

Rotate radial tires that have an asymmetric tread pattern only from front to rear and not from right to left. Do not use the compact spare tire for tire rotation.

⚠ WARNING - Mixing tire types

Do not mix bias ply and radial ply tires under any circumstances. This may cause unusual handling characteristics.

تلفن شبانه روزی: +۲۱-۸۸۸۶۲۰۸۵

FarmaSOS.com

Wheel alignment and tire balance

The wheels on your vehicle were aligned and balanced carefully at the factory to give you the longest tire life and best overall performance.

In most cases, you will not need to have your wheels aligned again. However, if you notice unusual tire wear or your vehicle pulling one way or the other, the alignment may need to be reset.

If you notice your vehicle vibrating when driving on a smooth road, your wheels may need to be rebalanced.

⚠ CAUTION - Wheel weight

Improper wheel weights can damage your vehicle's aluminum wheels. Use only approved wheel weights.

Tire replacement



If the tire is worn evenly, a tread wear indicator will appear as a solid band across the tread. This shows there is less than 1.6 mm (1/16 inch) of tread left on the tire. Replace the tire when this happens.

Do not wait for the band to appear across the entire tread before replacing the tire.

The ABS works by comparing the speed of the wheels. Tire size can affect wheel speed. When replacing tires, all 4 tires must use the same size originally supplied with the vehicle. Using tires of a different size can cause the ABS (Anti-lock Brake System) and ESC (Electronic Stability Control) (if equipped) to work irregularly.

امداد خودرو فارما

تلفن شبانه روزی: ۰۲۱-۸۸۸۶۲۰۸۵

FarmaSOS.com

Compact spare tire replacement

A compact spare tire has a shorter tread life than a regular size tire. Replace it when you can see the tread wear indicator bars on the tire. The replacement compact spare tire should be the same size and design tire as the one provided with your new vehicle and should be mounted on the same compact spare tire wheel. The compact spare tire is not designed to be mounted on a regular size wheel, and the compact spare tire wheel is not designed for mounting a regular size tire.

Wheel replacement

When replacing the metal wheels for any reason, make sure the new wheels are equivalent to the original factory units in diameter, rim width and offset.

A wheel that is not the correct size may adversely affect wheel and bearing life, braking and stopping abilities, handling characteristics, ground clearance, body-to-tire clearance, snow chain clearance, speedometer and odometer calibration, headlight aim and bumper height.

CAUTION - Wheel

Wheels that do not meet Kia's specifications may fit poorly and result in damage to the vehicle or unusual handling and poor vehicle control.

Tire traction

Tire traction can be reduced if you drive on worn tires, tires that are improperly inflated or on slippery road surfaces. Tires should be replaced when tread wear indicators appear. Slow down whenever there is rain, snow or ice on the road, to reduce the possibility of losing control of the vehicle.

Tire maintenance

In addition to proper inflation, correct wheel alignment helps to decrease tire wear. If you find a tire is worn unevenly, have your dealer check the wheel alignment.

When you have new tires installed, make sure they are balanced. This will increase vehicle ride comfort and tire life. Additionally, a tire should always be rebalanced if it is removed from the wheel.

Tire sidewall labeling

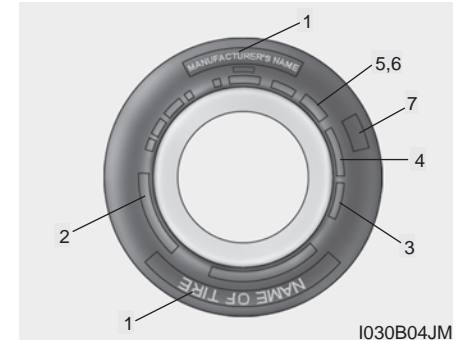

This information identifies and describes the fundamental characteristics of the tire and also provides the tire identification number (TIN) for safety standard certification. The TIN can be used to identify the tire in case of a recall.

1. Manufacturer or brand name

Manufacturer or Brand name is shown.

2. Tire size designation

A tire's sidewall is marked with a tire size designation. You will need this information when selecting replacement tires for your car. The following explains what the letters and numbers in the tire size designation mean.

Example tire size designation:

(These numbers are provided as an example only; your tire size designation could vary depending on your vehicle.)

P205/55R16 89H

P - Applicable vehicle type (tires marked with the prefix "P" are intended for use on passenger vehicles or light trucks; however, not all tires have this marking).

205 - Tire width in millimeters.

55 - Aspect ratio. The tire's section height as a percentage of its width.

R - Tire construction code (Radial).

16 - Rim diameter in inches.

89 - Load Index, a numerical code associated with the maximum load the tire can carry.

H - Speed Rating Symbol. See the speed rating chart in this section for additional information.

Wheel size designation

Wheels are also marked with important information that you need if you ever have to replace one. The following explains what the letters and numbers in the wheel size designation mean.

Example wheel size designation:

6.0JX16

6.0 - Rim width in inches.

J - Rim contour designation.

16 - Rim diameter in inches.

Tire speed ratings

The chart below lists many of the different speed ratings currently being used for passenger vehicles. The speed rating is part of the tire size designation on the sidewall of the tire. This symbol corresponds to that tire's designed maximum safe operating speed.

Speed Rating Symbol	Maximum Speed
S	180 km/h (112 mph)
T	190 km/h (118 mph)
H	210 km/h (130 mph)
V	240 km/h (149 mph)
Z	240 km/h (Above 149 mph)

3. Checking tire life (TIN : Tire Identification Number)

Any tires that are over 6 years old, based on the manufacturing date, (including the spare tire) should be replaced by new ones. You can find the manufacturing date on the tire sidewall (possibly on the inside of the wheel), displaying the DOT Code. The DOT Code is a series of numbers on a tire consisting of numbers and English letters. The manufacturing date is designated by the last four digits (characters) of the DOT code.

DOT : XXXX XXXX OOOO

The front part of the DOT means a plant code number, tire size and tread pattern and the last four numbers indicate week and year manufactured.

For example:

DOT XXXX XXXX 1613 represents that the tire was produced in the 16th week of 2013.

⚠ WARNING - Tire age

Replace tires within the recommended time frame. Failure to replace tires as recommended can result in sudden tire failure, which could lead to a loss of control and an accident.

4. Tire ply composition and material

The number of layers or plies of rubber-coated fabric in the tire. Tire manufacturers also must indicate the materials in the tire, which include steel, nylon, polyester, and others. The letter "R" means radial ply construction; the letter "D" means diagonal or bias ply construction; and the letter "B" means belted-bias ply construction.

5. Maximum permissible inflation pressure

This number is the greatest amount of air pressure that should be put in the tire. Do not exceed the maximum permissible inflation pressure. Refer to the Tire and Loading Information label for recommended inflation pressure.

6. Maximum load rating

This number indicates the maximum load in kilograms and pounds that can be carried by the tire. When replacing the tires on the vehicle, always use a tire that has the same load rating as the factory installed tire.

7. Uniform tire quality grading

Quality grades can be found where applicable on the tire sidewall between tread shoulder and maximum section width.

For example:

TREADWEAR 440

TRACTION A

TEMPERATURE A

Tread wear

The tread wear grade is a comparative rating based on the wear rate of the tire when tested under controlled conditions on a specified government test course. For example, a tire graded 150 would wear one-and-a-half times (1½) as well on the government course as a tire graded 100.

The relative performance of tires depends upon the actual conditions of their use, however, and may depart significantly from the norm due to variations in driving habits, service practices and differences in road characteristics and climate.

Tires degrade over time, even when they are not being used. Regardless of the remaining tread, we recommend that tires be replaced after approximately six (6) years of normal service. Heat caused by hot climates or frequent high loading conditions can accelerate the aging process.

These grades are molded on the side-walls of passenger vehicle tires. The tires available as standard or optional equipment on your vehicles may vary with respect to grade.

تلفن شبانه روزی: ۰۲۱-۸۸۸۶۲۰۸۵

FarmaSOS.com

Traction - AA, A, B & C

The traction grades, from highest to lowest, are AA, A, B and C. Those grades represent the tires ability to stop on wet pavement as measured under controlled conditions on specified government test surfaces of asphalt and concrete. A tire marked C may have poor traction performance.

The traction grade assigned to this tire is based on straight-ahead braking traction tests, and does not include acceleration, cornering, hydroplaning, or peak traction characteristics.

Temperature -A, B & C

The temperature grades are A (the highest), B and C representing the tire's resistance to the generation of heat and its ability to dissipate heat when tested under controlled conditions on a specified indoor laboratory test wheel.

Sustained high temperature can cause the material of the tire to degenerate and reduce tire life, and excessive temperature can lead to sudden tire failure. Grades B and A represent higher levels of performance on the laboratory test wheel than the minimum required by law.

Tire terminology and definitions

Air Pressure: The amount of air inside the tire pressing outward on the tire. Air pressure is expressed in pounds per square inch (psi) or kilopascal (kPa).

Accessory Weight: This means the combined weight of optional accessories. Some examples of optional accessories are, automatic transaxle, power seats, and air conditioning.

Aspect Ratio: The relationship of a tire's height to its width.

Belt: A rubber coated layer of cords that is located between the plies and the tread. Cords may be made from steel or other reinforcing materials.

Bead: The tire bead contains steel wires wrapped by steel cords that hold the tire onto the rim.

Bias Ply Tire: A pneumatic tire in which the plies are laid at alternate angles less than 90 degrees to the centerline of the tread.

Cold Tire Pressure: The amount of air pressure in a tire, measured in pounds per square inch (psi) or kilopascals (kPa) before a tire has built up heat from driving.

Curb Weight: This means the weight of a motor vehicle with standard and optional equipment including the maximum capacity of fuel, oil and coolant, but without passengers and cargo.

DOT Markings: The DOT code includes the Tire Identification Number (TIN), an alphanumeric designator which can also identify the tire manufacturer, production plant, brand and date of production.

GVWR: Gross Vehicle Weight Rating

GAWR FRT: Gross Axle Weight Rating for the Front Axle.

GAWR RR: Gross Axle Weight Rating for the Rear axle.

Intended Outboard Sidewall: The side of an asymmetrical tire, that must always face outward when mounted on a vehicle.

Kilopascal (kPa): The metric unit for air pressure.

Load Index: An assigned number ranging from 1 to 279 that corresponds to the load carrying capacity of a tire.

Maximum Inflation Pressure: The maximum air pressure to which a cold tire may be inflated. The maximum air pressure is molded onto the sidewall.

Maximum Load Rating: The load rating for a tire at the maximum permissible inflation pressure for that tire.

Maximum Loaded Vehicle Weight: The sum of curb weight; accessory weight; vehicle capacity weight; and production options weight.

Normal Occupant Weight: The number of occupants a vehicle is designed to seat multiplied by 68 kg (150 pounds).

Occupant Distribution: Designated seating positions.

Outward Facing Sidewall: The side of a asymmetrical tire that has a particular side that faces outward when mounted on a vehicle. The outward facing sidewall bears white lettering or bears manufacturer, brand, and/or model name molding that is higher or deeper than the same moldings on the inner facing sidewall.

Passenger (P-Metric) Tire: A tire used on passenger cars and some light duty trucks and multipurpose vehicles.

Recommended Inflation Pressure: Vehicle manufacturer's recommended tire inflation pressure and shown on the tire placard.

Radial Ply Tire: A pneumatic tire in which the ply cords that extend to the beads are laid at 90 degrees to the centerline of the tread.

Rim: A metal support for a tire and upon which the tire beads are seated.

Sidewall: The portion of a tire between the tread and the bead.

Speed Rating: An alphanumeric code assigned to a tire indicating the maximum speed at which a tire can operate.

Traction: The friction between the tire and the road surface. The amount of grip provided.

Tread: The portion of a tire that comes into contact with the road.

Treadwear Indicators: Narrow bands, sometimes called "wear bars," that show across the tread of a tire when only 2/32 inch of tread remains.

UTQGS: Uniform Tire Quality Grading Standards, a tire information system that provides consumers with ratings for a tire's traction, temperature and treadwear. Ratings are determined by tire manufacturers using government testing procedures. The ratings are molded into the sidewall of the tire.

Vehicle Capacity Weight: The number of designated seating positions multiplied by 68 kg (150 lbs.) plus the rated cargo and luggage load.

Vehicle Maximum Load on the

Tire: Load on an individual tire due to curb and accessory weight plus maximum occupant and cargo weight.

Vehicle Normal Load on the Tire:

Load on an individual tire that is determined by distributing to each axle its share of the curb weight, accessory weight, and normal occupant weight and driving by 2.

Vehicle Placard: A label permanently attached to a vehicle showing the original equipment tire size and recommended inflation pressure.

All season tires

Kia specifies all season tires on some models to provide good performance for use all year round, including snowy and icy road conditions. All season tires are identified by ALL SEASON and/or M+S (Mud and Snow) on the tire sidewall. Snow tires have better snow traction than all season tires and may be more appropriate in some areas.

Summer tires

Kia specifies summer tires on some models to provide superior performance on dry roads. Summer tire performance is substantially reduced in snow and ice. Summer tires do not have the tire traction rating M+S (Mud and Snow) on the tire side wall. If you plan to operate your vehicle in snowy or icy conditions, Kia recommends the use of snow tires or all season tires on all four wheels.

Snow tires

If you equip your car with snow tires, they should be the same size and have the same load capacity as the original tires. Snow tires should be installed on all four wheels; otherwise, poor handling may result.

Snow tires should carry 28 kPa (4 psi) more air pressure than the pressure recommended for the standard tires on the tire label on the driver's side of the center pillar, or up to the maximum pressure shown on the tire sidewall, whichever is less.

Do not drive faster than 120 km/h (75 mph) when your vehicle is equipped with snow tires.

Radial-ply tires

Radial-ply tires provide improved tread life, road hazard resistance and smoother high speed ride. The radial-ply tires used on this vehicle are of belted construction and are selected to complement the ride and handling characteristics of your vehicle.

Radial-ply tires have the same load carrying capacity as bias-ply or bias belted tires of the same size and use the same recommended inflation pressure. Mixing of radial-ply tires with bias-ply or bias belted tires is not recommended. Any combinations of radial-ply and bias-ply or bias belted tires when used on the same vehicle will seriously deteriorate vehicle handling. The best rule to follow is: identical radial-ply tires should always be used as a set of four.

Longer wearing tires can be more susceptible to irregular tread wear. It is very important to follow the tire rotation interval shown in this section to achieve the tread life potential of these tires. Cuts and punctures in radial-ply tires are repairable only in the tread area, because of sidewall flexing. Consult your tire dealer for radial-ply tire repairs.

Low aspect ratio tire (if equipped)

Low aspect ratio tires, whose aspect ratio is lower than 50, are provided for sporty looks.

Because the low aspect ratio tires are optimized for handling and braking, it may be more uncomfortable to ride in and there is more noise compare with normal tires.

امداد خودرو فارما

تلفن شبانه روزی: ۰۸۵-۸۸۸۶۲۰۲۱

FarmaSOS.com

CAUTION

Because the sidewall of the low aspect ratio tire is shorter than the normal, the wheel and tire of the low aspect ratio tire is easier to be damaged. So, follow the instructions below.

- *When driving on a rough road or off road, drive cautiously because tires and wheels may be damaged. And after driving, inspect tires and wheels.*
- *When passing over a pothole, speed bump, manhole, or curb stone, drive slowly so that the tires and wheels are not damaged.*
- *If the tire is impacted, we recommend that you inspect the tire condition or contact an authorized Kia dealer.*
- *To prevent damage to the tire, inspect the tire condition and pressure every 3,000km.*

CAUTION

- *It is not easy to recognize the tire damage with your own eyes. But if there is the slightest hint of tire damage, even though you cannot see the tire damage with your own eyes, have the tire checked or replaced because the tire damage may cause air leakage from the tire.*
- *If the tire is damaged by driving on a rough road, off road, pothole, manhole, or curb stone, it will not be covered by the warranty.*
- *You can find out the tire information on the tire sidewall.*

FarmaSOS.com

FUSES

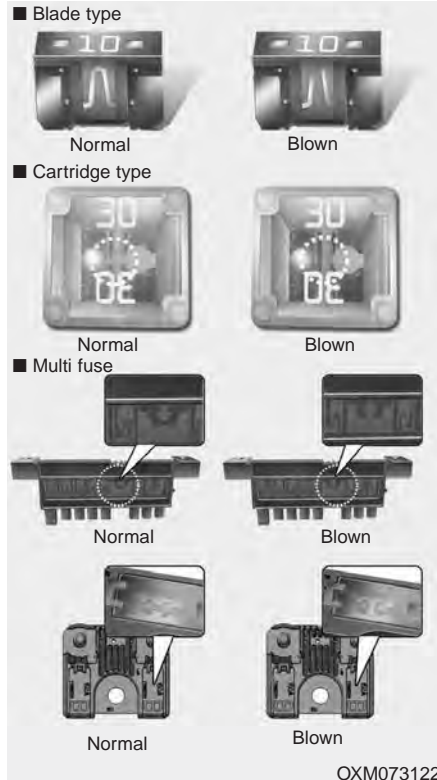

A vehicle's electrical system is protected from electrical overload damage by fuses.

This vehicle has 2 fuse panels, one located in the driver's side panel bolster, the other in the engine compartment near the battery.

If any of your vehicle's lights, accessories, or controls do not work, check the appropriate circuit fuse. If a fuse has blown, the element inside the fuse has melted.

If the electrical system does not work, first check the driver's side fuse has melted.

Before replacing a blown fuse, disconnect the negative battery cable.

Always replace a blown fuse with one of the same rating.

If the replacement fuse blows, this indicates an electrical problem. Avoid using the system involved and immediately consult an authorized Kia dealer.

Three kinds of fuses are used: blade type for lower amperage rating, cartridge type, and multi fuse for higher amperage ratings.

⚠ WARNING - Fuse replacement

- **Never replace a fuse with anything but another fuse of the same rating.**
- **A higher capacity fuse could cause damage and possibly a fire.**
- **Never install a wire or aluminum foil instead of the proper fuse - even as a temporary repair. It may cause extensive wiring damage and a possible fire.**

⚠ CAUTION

Do not use a screwdriver or any other metal object to remove fuses because it may cause a short circuit and damage the system.

*** NOTICE**

The actual fuse/relay panel label may differ from equipped items.

CAUTION

- *When replacing a blown fuse or relay with a new one, make sure the new fuse or relay fits tightly into the clips. The incomplete fastening fuse or relay may cause the vehicle wiring and electric systems damage and a possible fire.*
- *Do not input any other objects except fuses or relays into fuse/relay terminals such as a driver or wiring. It may cause contact failure and system malfunction.*

Instrument panel fuse replacement

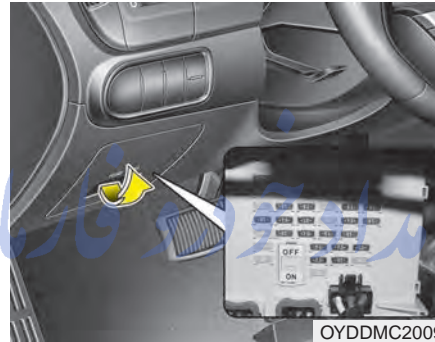

1. Turn the ignition switch, and all other switches off.
2. Open the fuse panel cover.

FarmaSOS.com

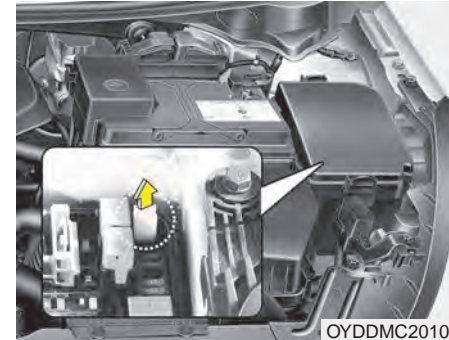

3. Pull the suspected fuse straight out. Use the removal tool provided in the engine compartment fuse panel.
4. Check the removed fuse; replace it if it is blown.
5. Push in a new fuse of the same rating, and make sure it fits tightly in the clips.

If it fits loosely, consult an authorized Kia dealer.

If you do not have a spare, use a fuse of the same rating from a circuit you may not need for operating the vehicle, such as the cigarette lighter fuse.

If the headlights or other electrical components do not work and the fuses are OK, check the fuse panel in the engine compartment. If a fuse is blown, it must be replaced.

Fuse switch

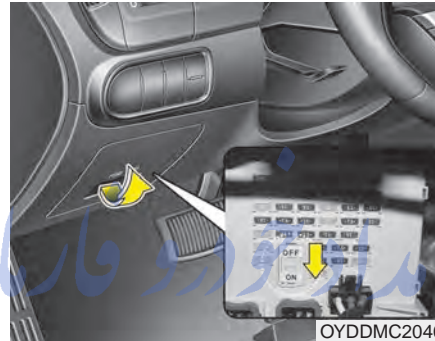

Your vehicle is equipped with a fuse switch to prevent battery discharge if your vehicle is parked without being operated for prolonged periods.

Use the following procedures before parking the vehicle for prolonged periods.

1. Turn off the engine.
2. Turn off the headlights and tail lights.
3. Open the driver's side panel cover and pull up the memory fuse.

* NOTICE

- If the fuse switch is off, the warning chime, audio, clock and interior lamps, etc., will not operate. Some items must be reset after replacement. Refer to “Battery” in this chapter.
- Even when the fuse switch is pulled up, the battery can still be discharged by operation of the headlights or other electrical devices.

Engine compartment fuse replacement

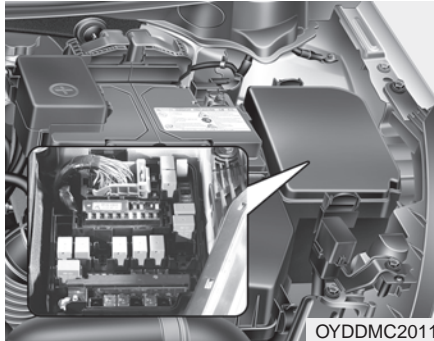

1. Turn the ignition switch and all other switches off.
2. Remove the fuse panel cover by pressing the tab and pulling the cover up.
3. Check the removed fuse; replace it if it is blown. To remove or insert the fuse, use the fuse puller in the engine compartment fuse panel.
4. Push in a new fuse of the same rating, and make sure it fits tightly in the clips. If it fits loosely, consult an authorized Kia dealer.

CAUTION

After checking the fuse panel in the engine compartment, securely install the fuse panel cover. If not, electrical failures may occur from water contact.

امداد خودرو فارما

تلفن شبانه روزی: ۰۲۱-۸۸۸۶۲۰۸۵

FarmaSOS.com

Main fuse

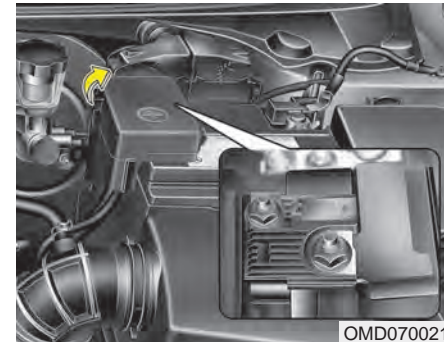

If the main fuse is blown, it must be removed as follows:

1. Turn off the engine.
2. Disconnect the negative battery cable.
3. Remove the nuts shown in the picture above.
4. Replace the fuse with a new one of the same rating.
5. Reinstall in the reverse order of removal.

Multi fuse

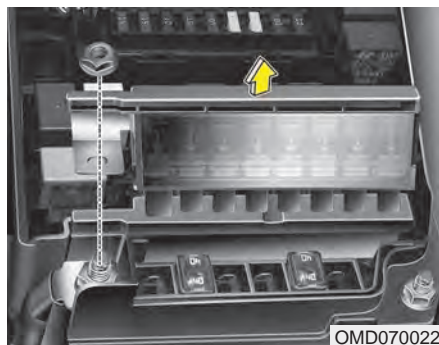

If the multi fuse is blown, it must be removed as follows:

1. Remove the fuse panel in the engine compartment.
2. Remove the nuts shown in the picture above.
3. Replace the fuse with a new one of the same rating.
4. Reinstall in the reverse order of removal.

امداد خودرو فارما

تلفن شبانه روزی: ۰۲۱-۸۸۸۶۲۰۸۵

FarmaSOS.com

Fuse/relay panel description



OYDDMC2012

Inside the fuse/relay panel covers, you can find the fuse/relay label describing fuse/relay name and capacity.

* NOTICE

Not all fuse panel descriptions in this manual may be applicable to your vehicle. It is accurate at the time of printing. When you inspect the fuse panel in your vehicle, refer to the fuse panel label.

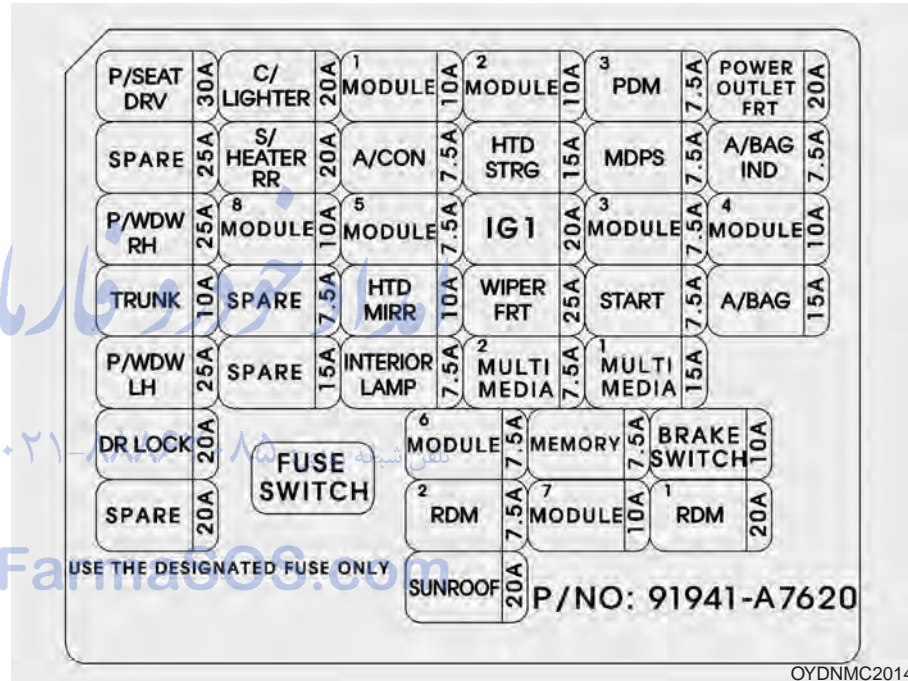

Engine room (Battery terminal cover)

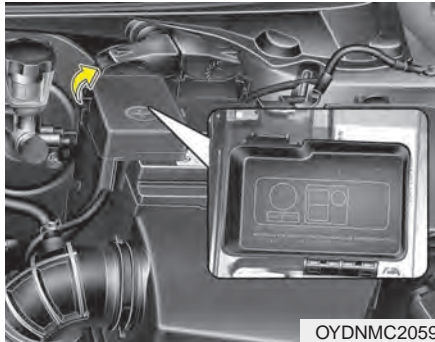

OYDNMC2059

* NOTICE

Not all fuse panel descriptions in this manual may be applicable to your vehicle. It is accurate at the time of printing. When you inspect the fuse panel in your vehicle, refer to the fuse panel label.



Instrument panel fuse panel

Fuse Name	Fuse rating	Circuit Protected
P/SEAT DRV	30A	Driver IMS Module, Driver Seat Manual Switch
SPARE 4	25A	-
P/WDW RH	25A	Smart Junction Box (Power Window RH Relay), Passenger Safety Power Window Module
TRUNK	10A	Smart Junction Box (Trunk Relay)
P/WDW LH	25A	Smart Junction Box (Power Window LH Relay), Driver Safety Power Window Module
DR LOCK	20A	Smart Junction Box (Door Lock Relay, Door Unlock Relay), ICM Relay Box (Two Turn Unlock Relay)
SPARE 3	20A	-
C/LIGHTER	20A	Cigarette Lighter & Power Outlet (Cigarette Lighter)
S/HEATER RR	20A	Rear Seat Warmer LH/RH
MODULE 8	10A	BCM, Smart Key Control Module
SPARE 2	7.5A	-
SPARE 1	15A	-
MODULE 1	10A	Smart Key Control Module, BCM, Digital Clock, Audio, A/V & Navigation Head Unit, Power Outside Mirror Switch, DC-DC Converter, MTS Module
A/CON	7.5A	A/C Control Module, Cluster Ionizer, E/R Fuse & Relay Box (Blower Relay, GSL PTC Relay)
MODULE 5	7.5A	Sunroof, Driver CCS Control Module, Passenger Seat Warmer Module, Rear Seat Warmer LH/RH
HTD MIRR	10A	ECM/PCM, A/C Control Module, Driver/Passenger Power Outside Mirror
INTERIOR LAMP	7.5A	Trunk Room Lamp, Glove Box Lamp, Vanity Lamp LH/RH, Room Lamp, Overhead Console Lamp, Ignition Key ILL. & Door Warning Switch (W/O Smart Key)
MODULE 6	7.5A	Sport Mode Switch, Key Solenoid
PDM 2	7.5A	[With Smart Key] Smart Key Control Module [W/O Smart Key] Immobilizer Module
SUNROOF	20A	Sunroof
MODULE 2	10A	Electro Chromic Mirror, Multipurpose Check Connector, A/C Control Module, Driver CCS Switch, Driver CCS Control Module, Passenger Seat Warmer Module Driver IMS Module, Passenger Seat Warmer Switch, A/V & Navigation Head Unit, DC-DC Converter, MTS Module, ATM Lever Indicator, PAS Off Switch Rear Seat Warmer LH/RH, Rear Power Window Switch LH/RH

Fuse Name	Fuse rating	Circuit Protected
HTD STRG	15A	Steering Wheel Heater
IG 1	20A	W/O Smart Key : E/R Fuse & Relay Box (Fuse - TCU 1, ECU 3, ABS 3)
WIPER FRT	25A	Wiper Motor, E/R Fuse & Relay Box (Wiper Relay), Multifunction Switch (Wiper)
MULTIMEDIA 2	7.5A	MTS Module
MEMORY	7.5A	Driver IMS Module, Driver Smart Key Outside Handle, Passenger Smart Key Outside Handle, BCM, Tire Pressure Monitoring Module, Auto Light & Photo Sensor Instrument Cluster, Data Link Connector, Multipurpose Check Connector, Digital Clock, A/C Control Module, Electro Chromic Mirror, Driver Power Outside Mirror Passenger Power Outside Mirror
MODULE 7	10A	ICM Relay Box (Turn Signal Lamp Sound Relay, Folding Relay, Unfolding Relay)
PDM 3	7.5A	[With Smart Key] Smart Key Control Module [W/O Smart Key] Immobilizer Module
MDPS	7.5A	MDPS Unit
MODULE 3	7.5A	Instrument Cluster
START	7.5A	[With Burglar Alarm & W/O Smart Key & W/O IMMO.] ICM Relay Box (Burglar Alarm Relay) [W/O Burglar Alarm or With Smart Key or With IMMO.] Transaxle Range Switch (A/T), E/R Fuse & Relay Box (Start 1 Relay), Smart Key Control Module, ECM
MULTIMEDIA 1	15A	Audio, A/V & Navigation Head Unit, DC-DC Converter
BRAKE SWITCH	10A	Stop Lamp Switch, Smart Key Control Module
PDM 1	20A	Smart Key Control Module
POWER OUTLET FRT	20A	Cigarette Lighter & Power Outlet (Power Outlet)
A/BAG IND	7.5A	Instrument Cluster (Air Bag IND.)
MODULE 4	10A	Crash Pad Switch, Tire Pressure Monitoring Module, Stop Lamp Switch, Digital Clock, BCM, ISG Off Switch, Rear Parking Assist Sensor LH (Out/In) Rear Parking Assist Sensor RH (Out/In), Front Parking Assist Sensor LH/RH
A/BAG	15A	SRS Control Module, Passenger Weight Classification Sensor

Engine compartment fuse panel

	Fuse Name	Fuse rating	Circuit Protected
MULTI FUSE	MDPS	80A	MDPS Unit
	B+1	60A	Smart Junction Box (ARISU-LT IPS 1 (4CH), Fuse - MODULE 6, MODULE 7, P/WDW LH, P/WDW RH, TRUNK)
	ABS 1	40A	ESC Module
	C/FAN	40A	C/Fan 1 Relay, C/Fan 2 Relay
	RR HTD	40A	RR HTD Relay
	BLOWER	40A	Blower Relay
	GSL PTC	60A	GSL PTC Relay
FUSE	B+2	60A	Smart Junction Box (ARISU-LT IPS 3 (4CH), ARISU-LT IPS 4 (4CH), IPS 5 (2CH), Fuse - PDM 1, P/SEAT DRV BRAKE SWITCH, S/HEATER RR)
	B/UP LAMP	10A	A/T : Electro Chromic Mirror, Audio, A/V & Navigation Head Unit, Rear Combination Lamp (In LH/RH Smart Junction Box (IPS Control Module), M/T : Back-Up Lamp Switch
	TCU 1	15A	Transaxle Range Switch, Vehicle Speed Sensor, Oil Pump Inverter, E/R Fuse & Relay Box (Fuse - B/UP LAMP)
	ABS 3	10A	ESC Module, Yaw Rate Sensor
	ECU 3	10A	ECM/PCM
	A/CON SWITCH	10A	A/C Control Module, Blower Motor, Blower Relay, ECM/PCM, Blower Resistor
	WIPER	10A	ECM/PCM, Wiper Motor, E/R Fuse & Relay Box (Wiper Relay)
	B+3	50A	Smart Junction Box (Leak Current Autocut Device, Fuse - PDM 2, DR LOCK, SUNROOF)
	EMS	40A	EMS Box (Engine Control Relay, Fuse -ECU 4, A/CON, F/PUMP)
	ISG INVERTER	50A	Oil Pump Inverter
DEICER	15A	ICM Relay Box (Front Deicer Relay)	

	Fuse Name	Fuse rating	Circuit Protected
FUSE	STOP LAMP	15A	Stop Signal Electronic Module
	S/HEATER FRT	20A	Driver CCS Control Module, Passenger Seat Warmer Module
	HORN	15A	Horn Relay, ICM Relay Box (Burglar Alarm Horn Relay)
	ECU 5	15A	G4NC : ECM/PCM
	IG 2	40A	W/O Smart Key : Ignition Switch, Start Relay, With Smart Key : PDM 4 (IG2) Relay, Start 1 Relay
	ABS 2	40A	ESC Module
	IG 1	40A	W/O Smart Key : Ignition Switch, With Smart Key : PDM 3 (IG1) Relay, PDM 2 (ACC) Relay

تلفن شبانه روزی: ۰۲۱-۸۸۸۶۲۰۸۵

FarmaSOS.com

Engine compartment fuse panel (EMS BOX)

Fuse Name	Fuse rating	Circuit Protected
F/PUMP	15A	F/Pump Relay
ECU 4	15A	ECM/PCM
A/CON	10A	A/CON COMP Relay
INJECTOR	10A	Injector #1/#2/#3/#4, F/Pump Relay, A/CON COMP Relay
ECU 2	10A	ECM/PCM
IGN COIL 1	20A	Ignition Coil #1/#2/#3/#4, Condenser
SPARE	20A	-
SENSOR 2	10A	Oxygen Sensor (Up), Oxygen Sensor (Down), Variable Intake Solenoid Valve, Oil Control Valve #1/#2 Purge Control Solenoid Valve, Canister Close Valve, E/R Fuse & Relay Box (C/Fan 1 Relay, C/Fan 2 Relay)
SENSOR 1	10A	Camshaft Position Sensor #1/#2

تلفن شبانه روزی: ۰۲۱-۸۸۸۶۲۰۸۵

FarmaSOS.com

APPEARANCE CARE

Exterior care

Exterior general caution

It is very important to follow the label directions when using any chemical cleaner or polish. Read all warning and caution statements that appear on the label.



CAUTION - Headlight Lens

To prevent damage, do not clean headlight lens with chemical solvents or strong detergents.

Finish maintenance

Washing

To help protect your vehicle's finish from rust and deterioration, wash it thoroughly and frequently at least once a month with lukewarm or cold water.

If you use your vehicle for off-road driving, you should wash it after each off-road trip. Pay special attention to the removal of any accumulation of salt, dirt, mud, and other foreign materials. Make sure the drain holes in the lower edges of the doors and rocker panels are kept clear and clean.

Insects, tar, tree sap, bird droppings, industrial pollution and similar deposits can damage your vehicle's finish if not removed immediately.

Even prompt washing with plain water may not completely remove all these deposits. A mild soap, safe for use on painted surfaces, may be used.

After washing, rinse the vehicle thoroughly with lukewarm or cold water. Do not allow soap to dry on the finish.

After washing the vehicle, test the brakes while driving slowly to see if they have been affected by water. If braking performance is impaired, dry the brakes by applying them lightly while maintaining a slow forward speed.

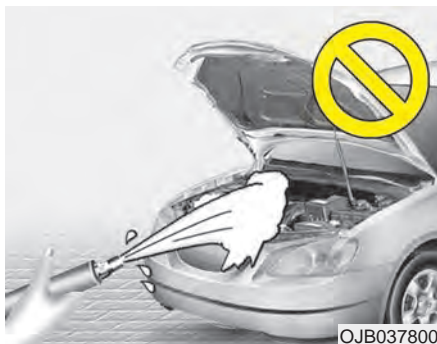

⚠ CAUTION - Wetting engine

- **Water washing in the engine compartment including high pressure water washing may cause the failure of electrical circuits located in the engine compartment.**
- **Never allow water or other liquids to come in contact with electrical/electronic components inside the vehicle as this may damage them.**

Waxing

Wax the vehicle when water will no longer bead on the paint.

Always wash and dry the vehicle before waxing. Use a good quality liquid or paste wax, and follow the manufacturer's instructions. Wax all metal trim to protect it and to maintain its luster.

Removing oil, tar, and similar materials with a spot remover will usually strip the wax from the finish. Be sure to re-wax these areas even if the rest of the vehicle does not yet need waxing.

تلفن شبانه روزی: ۰۲۱-۸۸۸۶۲۰۸۵

FarmaSOS.com

⚠ CAUTION - Drying vehicle

- **Wiping dust or dirt off the body with a dry cloth will scratch the finish.**
- **Do not use steel wool, abrasive cleaners, or strong detergents containing highly alkaline or caustic agents on chrome-plated or anodized aluminum parts. This may result in damage to the protective coating and cause discoloration or paint deterioration.**

Finish damage repair

Deep scratches or stone chips in the painted surface must be repaired promptly. Exposed metal will quickly rust and may develop into a major repair expense.

If your vehicle is damaged and requires any metal repair or replacement, be sure the body shop applies anti-corrosion materials to the parts repaired or replaced.

Bright-metal maintenance

- To remove road tar and insects, use a tar remover, not a scraper or other sharp object.
- To protect the surfaces of bright-metal parts from corrosion, apply a coating of wax or chrome preservative and rub to a high luster.
- During winter weather or in coastal areas, cover the bright metal parts with a heavier coating of wax or preservative. If necessary, coat the parts with non-corrosive petroleum jelly or other protective compound.

Underbody maintenance

Corrosive materials used for ice and snow removal and dust control may collect on the underbody. If these materials are not removed, accelerated rusting can occur on underbody parts such as the fuel lines, frame, floor pan and exhaust system, even though they have been treated with rust protection.

Thoroughly flush the vehicle underbody and wheel openings with lukewarm or cold water once a month, after off-road driving and at the end of each winter. Pay special attention to these areas because it is difficult to see all the mud and dirt. It will do more harm than good to wet down the road grime without removing it. The lower edges of doors, rocker panels, and frame members have drain holes that should not be allowed to clog with dirt; trapped water in these areas can cause rusting.

Aluminum or chrome wheel maintenance

The aluminum or chrome wheels are coated with a clear protective finish.

- Do not use any abrasive cleaner, polishing compound, solvent, or wire brushes on aluminum or chrome wheels. They may scratch or damage the finish.
- Clean the wheel when it has cooled.
- Use only a mild soap or neutral detergent, and rinse thoroughly with water. Also, be sure to clean the wheels after driving on salted roads. This helps prevent corrosion.
- Avoid washing the wheels with high-speed car wash brushes.
- Do not use any alkaline or acid detergent. It may damage and corrode the aluminum or chrome wheels coated with a clear protective finish.

Corrosion protection

Protecting your vehicle from corrosion

By using the most advanced design and construction practices to combat corrosion, we produce vehicles of the highest quality. However, this is only part of the job. To achieve the long-term corrosion resistance your vehicle can deliver, the owner's cooperation and assistance is also required.

Common causes of corrosion

The most common causes of corrosion on your vehicle are:

- Road salt, dirt and moisture that is allowed to accumulate underneath the vehicle.
- Removal of paint or protective coatings by stones, gravel, abrasion or minor scrapes and dents which leave unprotected metal exposed to corrosion.

High-corrosion areas

If you live in an area where your vehicle is regularly exposed to corrosive materials, corrosion protection is particularly important. Some of the common causes of accelerated corrosion are road salts, dust control chemicals, ocean air and industrial pollution.

Moisture breeds corrosion

Moisture creates the conditions in which corrosion is most likely to occur. For example, corrosion is accelerated by high humidity, particularly when temperatures are just above freezing. In such conditions, the corrosive material is kept in contact with the vehicle surfaces by moisture that is slow to evaporate.

Mud is particularly corrosive because it dries slowly and holds moisture in contact with the vehicle. Although the mud appears to be dry, it can still retain the moisture and promote corrosion.

High temperatures can also accelerate corrosion of parts that are not properly ventilated so the moisture can be dispersed. For all these reasons, it is particularly important to keep your vehicle clean and free of mud or accumulations of other materials. This applies not only to the visible surfaces but particularly to the underside of the vehicle.

To help prevent corrosion

You can help prevent corrosion from getting started by observing the following:

Keep your vehicle clean

The best way to prevent corrosion is to keep your vehicle clean and free of corrosive materials. Attention to the underside of the vehicle is particularly important.

- If you live in a high-corrosion area — where road salts are used, near the ocean, areas with industrial pollution, acid rain, etc.—, you should take extra care to prevent corrosion. In winter, hose off the underside of your vehicle at least once a month and be sure to clean the underside thoroughly when winter is over.
- When cleaning underneath the vehicle, give particular attention to the components under the fenders and other areas that are hidden from view. Do a thorough job; just dampening the accumulated mud rather than washing it away will accelerate corrosion rather than prevent it. Water under high pressure and steam are particularly effective in removing accumulated mud and corrosive materials.

- When cleaning lower door panels, rocker panels and frame members, be sure that drain holes are kept open so that moisture can escape and not be trapped inside to accelerate corrosion.

Keep your garage dry

Don't park your vehicle in a damp, poorly ventilated garage. This creates a favorable environment for corrosion. This is particularly true if you wash your vehicle in the garage or drive it into the garage when it is still wet or covered with snow, ice or mud. Even a heated garage can contribute to corrosion unless it is well ventilated so moisture is dispersed.

FarmaSOS.com

Keep paint and trim in good condition

Scratches or chips in the finish should be covered with "touch-up" paint as soon as possible to reduce the possibility of corrosion. If bare metal is showing through, the attention of a qualified body and paint shop is recommended.

Bird droppings : Bird droppings are highly corrosive and may damage painted surfaces in just a few hours. Always remove bird droppings as soon as possible.

Don't neglect the interior

Moisture can collect under the floor mats and carpeting and cause corrosion. Check under the mats periodically to be sure the carpeting is dry. Use particular care if you carry fertilizers, cleaning materials or chemicals in the car.

These should be carried only in proper containers and any spills or leaks should be cleaned up, flushed with clean water and thoroughly dried.

Interior care

Interior general precautions

Prevent chemicals such as perfume, cosmetic oil, sun cream, hand cleaner, and air freshener from contacting the interior parts because they may cause damage or discoloration. If they do contact the interior parts, wipe them off immediately. See the instructions for the proper way to clean vinyl.

⚠ CAUTION - Electrical components

Never allow water or other liquids to come in contact with electrical/electronic components inside the vehicle as this may damage them.

⚠ CAUTION - Leather

When cleaning leather products (steering wheel, seats etc.), use neutral detergents or low alcohol content solutions. If you use high alcohol content solutions or acid/alkaline detergents, the color of the leather may fade or the surface may get stripped off.

Cleaning the upholstery and interior trim

Vinyl

Remove dust and loose dirt from vinyl with a whisk broom or vacuum cleaner. Clean vinyl surfaces with a vinyl cleaner.

Fabric

Remove dust and loose dirt from fabric with a whisk broom or vacuum cleaner. Clean with a mild soap solution recommended for upholstery or carpets. Remove fresh spots immediately with a fabric spot cleaner. If fresh spots do not receive immediate attention, the fabric can be stained and its color can be affected. Also, its fire-resistant properties can be reduced if the material is not properly maintained.

Using anything but recommended cleaners and procedures may affect the fabric's appearance and fire-resistant properties.

تلفن شبانه روزی: ۰۲۱-۸۸۸۶۲۰۸۵

FarmaSOS.com

Cleaning the lap/shoulder belt webbing

Clean the belt webbing with any mild soap solution recommended for cleaning upholstery or carpet. Follow the instructions provided with the soap. Do not bleach or re-dye the webbing because this may weaken it.

Cleaning the interior window glass

If the interior glass surfaces of the vehicle become fogged (that is, covered with an oily, greasy or waxy film), they should be cleaned with glass cleaner. Follow the directions on the glass cleaner container.

**CAUTION - Rear windows**

Do not scrape or scratch the inside of the rear window. This may result in damage to the rear window defroster grid.

امداد خودرو فارما

تلفن شبانه روزی: ۰۲۱-۸۸۸۶۲۰۸۵

FarmaSOS.com

EMISSION CONTROL SYSTEM

The emission control system of your vehicle is covered by a written limited warranty. Please see the warranty information contained in the Warranty & Consumer Information manual in your vehicle.

Your vehicle is equipped with an emission control system to meet all applicable emission regulations.

There are three emission control systems, as follows.

- (1) Crankcase emission control system
- (2) Evaporative emission control system
- (3) Exhaust emission control system

In order to assure the proper function of the emission control systems, it is recommended that you have your vehicle inspected and maintained by an authorized Kia dealer in accordance with the maintenance schedule in this manual.

Caution for the Inspection and Maintenance Test (With Electronic Stability Control (ESC) system)

- To prevent the vehicle from misfiring during dynamometer testing, turn the Electronic Stability Control (ESC) system off by pressing the ESC switch.
- After dynamometer testing is completed, turn the ESC system back on by pressing the ESC switch again.

تلفن شبانه روزی: ۰۲۱-۸۸۸۶۲۰۸۵

FarmaSOS.com

1. Crankcase emission control system

The positive crankcase ventilation system is employed to prevent air pollution caused by blow-by gases being emitted from the crankcase. This system supplies fresh filtered air to the crankcase through the air intake hose. Inside the crankcase, the fresh air mixes with blow-by gases, which then pass through the PCV valve into the induction system.

2. Evaporative emission control (including ORVR: Onboard Refueling Vapor Recovery) system

The Evaporative Emission Control System is designed to prevent fuel vapors from escaping into the atmosphere.

(The ORVR system is designed to allow the vapors from the fuel tank to be loaded into a canister while refueling at the gas station, preventing the escape of fuel vapors into the atmosphere.)

Canister

Fuel vapors generated inside the fuel tank are absorbed and stored in the onboard canister. When the engine is running, the fuel vapors absorbed in the canister are drawn into the surge tank through the purge control solenoid valve.

Purge Control Solenoid Valve (PCSV)

The purge control solenoid valve is controlled by the Engine Control Module (ECM); when the engine coolant temperature is low during idling, the PCSV closes so that evaporated fuel is not taken into the engine. After the engine warms up during ordinary driving, the PCSV opens to introduce evaporated fuel to the engine.

3. Exhaust emission control system

The Exhaust Emission Control System is a highly effective system which controls exhaust emissions while maintaining good vehicle performance.

Vehicle modifications

This vehicle should not be modified. Modification of your vehicle could affect its performance, safety or durability and may even violate governmental safety and emissions regulations.

In addition, damage or performance problems resulting from any modification may not be covered under warranty.

- If you use unauthorized electronic devices, it may cause the vehicle to operate abnormally, wire damage, battery discharge and fire. For your safety, do not use unauthorized electronic devices.

Engine exhaust gas precautions (carbon monoxide)

- Carbon monoxide can be present with other exhaust fumes. Therefore, if you smell exhaust fumes of any kind inside your vehicle, have it inspected and repaired immediately. If you ever suspect exhaust fumes are coming into your vehicle, drive it only with all the windows fully open. Have your vehicle checked and repaired immediately.

⚠ WARNING - Exhaust

Engine exhaust gases contain carbon monoxide (CO). Though colorless and odorless, it is dangerous and could be lethal if inhaled. Follow the instructions on this page to avoid CO poisoning.

- Do not operate the engine in confined or closed areas (such as garages) any more than what is necessary to move the vehicle in or out of the area.
- When the vehicle is stopped in an open area for more than a short time with the engine running, adjust the ventilation system (as needed) to draw outside air into the vehicle.
- Never sit in a parked or stopped vehicle for any extended time with the engine running.
- When the engine stalls or fails to start, excessive attempts to restart the engine may cause damage to the emission control system.

⚠ WARNING - Catalytic converter

Keep away from the catalytic converter and exhaust system while the vehicle is running or immediately thereafter. The exhaust and catalytic systems are very hot and may burn you.

Operating precautions for catalytic converters (if equipped)

⚠ WARNING - Fire

- **Do not park, idle or drive the vehicle over or near flammable objects, such as grass, vegetation, paper, leaves, etc. A hot exhaust system can ignite flammable items under your vehicle.**
- **Also, do not remove the heat sink around the exhaust system, do not seal the bottom of the vehicle or do not coat the vehicle for corrosion control. It may present a fire risk under certain conditions.**

Your vehicle is equipped with a catalytic converter emission control device.

Therefore, the following precautions must be observed:

- Use only UNLEADED FUEL for gasoline engines.
- Do not operate the vehicle when there are signs of engine malfunction, such as misfire or a noticeable loss of performance.
- Do not misuse or abuse the engine. Examples of misuse are coasting with the ignition off and descending steep grades in gear with the ignition off.
- Do not operate the engine at high idle speed for extended periods (5 minutes or more).
- Do not modify or tamper with any part of the engine or emission control system. All inspections and adjustments must be made by an authorized Kia dealer.
- Avoid driving with a extremely low fuel level. Running out of fuel could cause the engine to misfire, damaging the catalytic converter.

Failure to observe these precautions could result in damage to the catalytic converter and to your vehicle. Additionally, such actions could void your warranties.

Specifications & Consumer information

Engine	8-2
Dimensions	8-2
Bulb wattage	8-3
Tires and wheels	8-4
Weight/volume	8-5
Recommended lubricants and capacities.....	8-6
• Recommended sae viscosity number	8-8
Vehicle identification number (VIN)	8-9
Vehicle certification label.....	8-9
Tire specification and pressure label	8-10
Engine number	8-10
Refrigerant label.....	8-10

تلفن شبانه روزی: ۰۲۱-۸۸۸۶۲۰۸۵

FarmaSOS.com

Specifications & Consumer information

ENGINE

Item	1.8 MPI	2.0 GDI
Displacement [cc (cu. in.)]	1,797 (109.66)	1,999 (121.99)
Bore x Stroke [mm (in.)]	81 x 87.2 (3.19 x 3.43)	81 x 97 (3.19 x 3.82)
Firing order	1 → 3 → 4 → 2	1 → 3 → 4 → 2
No. of cylinders	4, In-line	4, In-line

DIMENSIONS

Item	mm (in)	
Overall length	4,560 (179.5)	
Overall width	1,780 (70.1)	
Overall height	1,435 (56.5)	
Front tread	P195/65 R15 (Steel)	1,563 (61.5)
	P205/55 R16 (Steel)	1,553 (61.1)
	P205/55 R16	1,555 (61.2)
	P215/45 R17	1,557 (61.3)
Rear tread	P195/65 R15 (Steel)	1,576 (62.0)
	P205/55 R16 (Steel)	1,566 (61.6)
	P205/55 R16	1,568 (61.7)
	P215/45 R17	1,570 (61.8)
Wheelbase	2,700 (106.3)	

BULB WATTAGE

Light Bulb		Wattage	Bulb type	
Front	Headlamps(Low)	55	H11	
	Headlamps(Low)- HID *	25	D8S	
	Headlamps(High)	55	H1	
	Front turn signal lamps	28	PY28W/8W	
	Front position lamps *	5	PY28W/8W	
	Front position lamps (LED type)*	LED	LED	
	Front fog lamps *	35	H8	
	Side Repeater lamps	5	WY5W	
	Side Repeater lamps (Outside Mirror) *	LED	LED	
	Daytime running lamps *	55	H1	
	Side marker	5	W5W	
Rear	Bulb type	Rear Stop/Tail lamps (outside)	28/8	PY28/8
		Rear tail lamps (Inside)	8	P28/8
	LED type	Rear Stop/Tail lamps (outside)	LED	LED
		Rear Stop/tail lamps (Inside)	LED	LED
	Rear turn signal lamps	27	PY27W	
	Back-up lamps	16	W16W	
	Bulb type	High mounted stop lamp	21	P21W
	LED type		LED	LED
License plate lamps	5	W5W		
Interior	Map lamps *	8	FESTOON	
	Room lamps	8	FESTOON	
	Vanity mirror lamps *	5	FESTOON	
	Trunk room lamp *	5	FESTOON	
	Glove box lamp	5	FESTOON	

* : If equipped

TIRES AND WHEELS

Item	Tire size	Wheel size	Inflation pressure kPa (psi)				Wheel lug nut torque kg•m (lb•ft, N•m)
			Normal load *1		Maximum load		
			Front	Rear	Front	Rear	
Full size tire	P195/65R15 89T	6.0J X15	220 (32)	220 (32)	220 (32)	220 (32)	9~11 (65~79, 88~107)
	P205/55R16 89H	6.5J X16					
	P215/45R17 87H	7.0J X17					
Compact spare tire *2	T125/80D15 95M	4.0T×15	420 (60)	420 (60)	420 (60)	420 (60)	

*1 : Normal load : Up to 3 persons

*2 : If your vehicle is not equipped with a compact spare tire, it will be equipped with a Tire Mobility Kit

CAUTION

Using tires of a different size may damage the related parts or cause them to operate improperly.

FarmaSOS.com

WEIGHT/VOLUME

Item		1.8 MPI Engine		2.0 GDI Engine	
		Manual transaxle	Automatic transaxle	Manual transaxle	Automatic transaxle
Gross vehicle weight	kg (lbs.)	1,740 (3,836)	1,760 (3,880)	1,750 (3,858)	1,770 (3,902)
Luggage volume	l (cu ft)	421 (14.9)			

امداد خودرو فارما

تلفن شبانه روزی: ۰۲۱-۸۸۸۶۲۰۸۵

FarmaSOS.com

RECOMMENDED LUBRICANTS AND CAPACITIES

To help achieve proper engine and powertrain performance and durability, use only lubricants of the proper quality. The correct lubricants also help promote engine efficiency that results in improved fuel economy. These lubricants and fluids are recommended for use in your vehicle.

Lubricant		Volume	Classification
Engine oil ^{11 12} (drain and refill) Recommends		4.0 l (4.23 US qt.)	API Service SM, ILSAC GF-4 or above* ³
Manual transaxle fluid		1.8 l (2.0~2.1 US qt.)	API GL-4, SAE 75W/85, fill for-life
Automatic transaxle fluid		7.1 l (7.5 US qt.)	MICHANG ATF SP-IV, SK ATF SP-IV NOCA ATF SP-IV, Kia genuine ATF SP-IV
Coolant	Manual transaxle	6.0 l (6.34 US qt.)	Mixture of antifreeze and water (Ethylene glycol base coolant for aluminum radiator)
	Automatic transaxle	5.9 l (6.23 US qt.)	

Lubricant	Volume	Classification
Brake/clutch fluid	0.7~0.8 l (0.7~0.8 US qt.)	FMVSS116 DOT-3 or DOT-4
Fuel	50 l (13.2 US gal.)	Unleaded gasoline

*1 Refer to the recommended SAE viscosity numbers on the next page.

*2 Engine oils labeled Energy Conserving Oil are now available. Along with other additional benefits, they contribute to fuel economy by reducing the amount of fuel necessary to overcome engine friction. Often, these improvements are difficult to measure in everyday driving, but in a year's time, they can offer significant cost and energy savings.

*3 If the API service SM engine oil is not available in your country, you are able to use API service SL.

تلفن شبانه روزی: ۰۲۱-۸۸۸۶۲۰۸۵

FarmaSOS.com

Recommended SAE viscosity number

Always be sure to clean the area around any filler plug, drain plug, or dipstick before checking or draining any lubricant. This is especially important in dusty or sandy areas and when the vehicle is used on unpaved roads. Cleaning the plug and dipstick areas will prevent dirt and grit from entering the engine and other mechanisms that could be damaged.

Engine oil viscosity (thickness) has an effect on fuel economy and cold weather operation (engine start and engine oil flowability). Lower viscosity engine oils can provide better fuel economy and cold weather performance, however, higher viscosity engine oils are required for satisfactory lubrication in hot weather.

Using oils of any viscosity other than those recommended could result in engine damage. When choosing an oil, consider the range of temperature your vehicle will be operated in before the next oil change. Proceed to select the recommended oil viscosity from the chart.

Temperature Range for SAE Viscosity Numbers										
Temperature	°C	-30	-20	-10	0	10	20	30	40	50
	(°F)	-10	0	20	40	60	80	100	120	
Engine Oil *1		10W-30								
		5W-20, 5W-30								

*1 For better fuel economy, it is recommended to use the engine oil of a viscosity grade SAE 5W-20 (API SM / ILSAC GF-4). However, if the engine oil is not available in your country, select the proper engine oil using the engine oil viscosity chart.



VEHICLE IDENTIFICATION NUMBER (VIN)

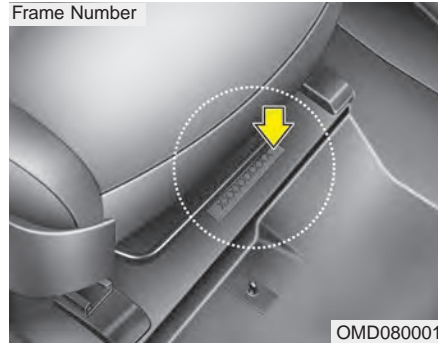

The vehicle identification number (VIN) is the number used in registering your vehicle and in all legal matters pertaining to its ownership, etc.



VIN label

The VIN is also on a plate attached to the top of the dashboard. The number on the plate can easily be seen through the windshield from outside.

VEHICLE CERTIFICATION-LABEL



The vehicle certification label attached on the driver's side center pillar gives the vehicle identification number (VIN).

FarmaSOS.com

TIRE SPECIFICATION AND PRESSURE LABEL



The tires supplied on your new vehicle are chosen to provide the best performance for normal driving.

The tire label located on the driver's side center pillar gives the tire pressures recommended for your vehicle.

ENGINE NUMBER

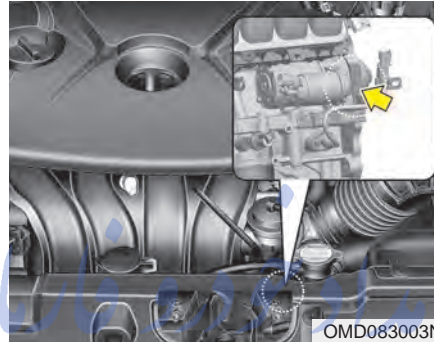

The engine number is stamped on the engine block as shown in the drawing.

تلفن شبانه روزی: ۰۲۱-۸۸۸۶۲۰۸۵

FarmaSOS.com

امداد خودرو فارما

تلفن شبانه روزی: ۰۲۱-۸۸۸۶۲۰۸۵

FarmaSOS.com

Index

A

Active eco system	5-40
Air bag-supplemental restraint system	3-33
Air bag warning label	3-55
Air bag warning light	3-36
Ari bag system operation	3-34
Curtain air bag	3-48
Do not install a child restraint on a front passenger's seat	3-35
Driver's and passenger's front air bag	3-44
Inflation/non-inflation conditions of air bag	3-49
Occupant detection system	3-39
Side air bag	3-47
SRS Care	3-54
SRS components and functions	3-37
Air cleaner	7-36
Filter replacement	7-36
Appearance care	7-71
Exterior care	7-71
Interior care	7-76
Audio system	4-144
Aux, USB and iPod® port	4-146
Glass antenna	4-144
Steering wheel audio control	4-145
Automatic climate control system	4-117
Automatic heating and air conditioning	4-118
Manual heating and air conditioning	4-119

System operation	4-125
Automatic transaxle	5-16
Automatic transaxle operation	5-16

B

Battery	7-41
Battery recharging	7-43
For best battery service	7-41
Reset items	7-43
Before driving	5-3
Brake system	5-22
Anti-lock brake system (ABS)	5-25
Electronic stability control (ESC)	5-27
Hill-start assist control (HAC)	5-31
Parking brake	5-23
Power brakes	5-22
Vehicle stability management (VSM)	5-31
Brake/clutch fluid	7-34
Checking the brake/clutch fluid level	7-34
Bulb wattage	8-3

C

Child restraint system	3-26
Lower anchor ststem	3-31
Tether Anchor system	3-30
Using a child restraint system	3-27

Climate control air filter 7-37
 Filter inspection 7-37
 Cruise control system 5-35

D

Defroster 4-106
 Front wiper deicer 4-106
 Rear window defroster 4-106
 Dimensions 8-2
 Door locks 4-18
 Auto door lock/unlock feature 4-20
 Child-protector rear door lock 4-21
 From inside 4-18
 From outside 4-18
 Impact sensing door unlock system 4-20
 Speed sensing door lock system 4-21

E

Economical operation 5-41
 Emergency starting 6-5
 If the engine overheats 6-7
 Jump starting 6-5
 Push-starting 6-6
 Emission control system 7-78
 Crankcase emission control system 7-78

Evaporative emission control
 (including ORVR: Onboard Refueling Vapor
 Recovery) system 7-78
 Exhaust emission control system 7-79
 Engine 8-2
 Engine compartment 2-6, 7-3
 Engine coolant 7-31
 Changing the coolant 7-33
 Checking the coolant level 7-31
 Engine number 8-10
 Engine oil 7-29
 Changing the engine oil and filter 7-30
 Checking the engine oil level 7-29
 Engine start/stop button 5-7
 ENGINE START/STOP button position 5-7
 Illuminated ENGINE START/STOP button 5-7
 Explanation of scheduled maintenance items 7-25
 Exterior overview 2-2

F

Fuel filler lid 4-31
 Closing the fuel filler lid 4-31
 Opening the fuel filler lid 4-31
 Fuel requirements 1-3
 Do not use methanol 1-4
 Fuel Additives 1-4
 Gasoline containing alcohol and methanol 1-3

Index

Fuses	7-58
Engine compartment fuse panel	7-64
Engine compartment fuse replacement	7-61
Engine room (Battery terminal cover)	7-65
Fuse/relay panel description	7-63
Instrument panel fuse replacement	7-59

H

Hood	4-29
Closing the hood	4-30
Opening the hood	4-29
How to use this manual	1-2

I

If the engine will not start	6-4
If engine doesn't turn over or turns over slowly	6-4
If engine turns over normally but does not start	6-4
If you have a flat tire (with spare tire)	6-14
Changing tires	6-15
Jack and tools	6-14
Removing and storing the spare tire	6-15
If you have a flat tire (with tire mobility kit)	6-8
Components of the TireMobilityKit	6-10
Introduction	6-8
Notes on the safe use of the Tire Mobility Kit	6-9
Using the Tire Mobility Kit	6-11

In case of an emergency while driving	6-3
If engine stalls while driving	6-3
If the engine stalls at a crossroad or crossing	6-3
If you have a flat tire while driving	6-3
Instrument cluster	4-52
Gauges	4-54
Instrument Cluster Control	4-53
LCD Display Control	4-54
Transaxle Shift Indicator	4-57
Instrument panel overview	2-5
Interior features	4-135
Ashtray	4-135
Cigarette lighter	4-135
Climate control seat	4-139
Clothes hanger	4-142
Cup holder	4-136
Floor mat anchor(s)	4-142
LCD monitor	4-141
Navigation system	4-143
Power outlet	4-140
Seat warmer	4-137
Sliding armrest	4-136
Sunvisor	4-137
Interior light	4-101
Automatic turn off function	4-101
Glove box lamp	4-103
Map lamp	4-101
Room lamp	4-102

Trunk room lamp	4-103
Vanity mirror lamp	4-104
Interior overview	2-4

K

Key positions	5-5
Keys	4-4
Key operations	4-4
Record your key number	4-4

L

LCD display	4-58
A/V Mode	4-63
LCD Modes	4-58
Service Mode	4-59
Turn By Turn Mode	4-63
User Settings Mode	4-60
Warning Messages	4-64
Lighting	4-93
Battery saver function	4-93
Daytime running light	4-94
Front fog light	4-98
Headlamp escort function	4-93
High - beam operation	4-96
Lighting control	4-94
Turn signals and lane change signals	4-97

M

Maintenance services	7-4
Owner maintenance precautions	7-5
Owner's responsibility	7-4
Manual climate control system	4-107
Climate control air filter	4-115
Heating and air conditioning	4-108
Refrigerant and compressor lubricant	4-116
System operation	4-113
Manual transaxle	5-13
Manual transaxle operation	5-13
Mirrors	4-43
Inside rearview mirror	4-43
Outside rearview mirror	4-48

O

Owner maintenance	7-6
Owner maintenance schedule	7-6

P

Parking assist system	4-86
Non-operational conditions	4-89
Operation	4-87
Self-diagnosis	4-91

Index

Parking brake	7-35
Checking the parking brake	7-35

R

Rearview camera.	4-92
Recommended lubricants and capacities	8-8
Recommended sae viscosity number	8-6
Refrigerant label	8-10
Remote keyless entry	4-9
Battery replacement	4-11
Immobilizer system	4-12
Remote keyless entry system operations	4-9
Transmitter precautions	4-10
Road warning	6-2
Hazard warning flasher	6-2

S

Scheduled maintenance service	7-8
Maintenance under severe usage conditions	7-23
Normal maintenance schedule	7-10
Seat	3-2
Driver position memory system	3-8
Folding the rear seat	3-14
Front seat adjustment - Manual	3-4
Front seat adjustment - Power	3-6
Headrest (Front seat)	3-10

Headrest (Rear seat)	3-11
Rear seat adjustment	3-11
Seatback pocket	3-11
Seat belt	3-16
Care of seat belts	3-25
Pre-tensioner seat belt	3-20
Seat belt (3-point system)	3-17
Seat belt precautions	3-23
Seat belt warning	3-17
Smart key	4-6
Precautions	4-7
Smart key function	4-6
Special driving conditions	5-43
Driving at night	5-44
Driving in flooded areas	5-45
Driving in the rain	5-45
Driving off-road	5-46
Hazardous driving conditions	5-43
Highway driving	5-46
Rocking the vehicle	5-43
Smooth cornering	5-44
Starting the engine	5-10
Steering wheel	4-38
Electronic power steering	4-38
Flex steer	4-40
Heated steering wheel	4-40
Horn	4-39
Tilt & telescopic steering	4-39

Storage compartment	4-132
Center console storage	4-132
Cool box	4-133
Glove box	4-132
Sunglass holder	4-133
Sunroof	4-34
Resetting the sunroof	4-37
Sliding the sunroof	4-35
Sunroof open warning	4-34
Sunshade	4-36
Tilting the sunroof	4-36

T

Theft-alarm system	4-15
Armed stage	4-15
Disarmed stage	4-16
Theft-alarm stage	4-16
Tire specification and pressure label	8-10
Tires and wheels	7-44
All season tires	7-55
Checking tire inflation pressure	7-45
Low aspect ratio tire	7-56
Radial-ply tires	7-56
Recommended cold tire inflation pressures	7-44
Snow tires	7-55
Summer tires	7-55
Tire care	7-44

Tire maintenance	7-49
Tire replacement	7-48
Tire rotation	7-46
Tire sidewall labeling	7-49
Tire traction	7-49
Wheel alignment and tire balance	7-47
Wheel replacement	7-49
Towing	6-22
Emergency towing	6-23
Removable towing hook	6-23
Towing service	6-22
Trailer towing	5-49
Trip computer	4-71
Fuel Economy	4-72
Overview	4-71
Trip A/B	4-73
Trunk	4-22
Closing the trunk	4-23
Emergency trunk safety release	4-23
Opening the trunk	4-22

V

Vehicle break-in process	1-5
Vehicle certification label	8-9
Vehicle identification number (VIN)	8-9
Vehicle load limit	5-50
Certification label	5-53

Index

Tire and loading information label	5-50	Winter driving	5-47
Vehicle weight	5-55	Wiper blades	7-38
Base curb weight	5-55	Blade inspection	7-38
Cargo weight	5-55	Blade replacement	7-38
GAW (Gross axle weight)	5-55	Wipers and washers	4-99
GAWR (Gross axle weight rating)	5-55	Windshield washers	4-99
GVW (Gross vehicle weight)	5-55	Windshield wipers	4-99
GVWR (Gross vehicle weight rating)	5-55		
Vehicle curb weight	5-55		
W			
Warning and indicator lights	4-75		
Indicator Lights	4-81		
Warning lights	4-75		
Washer fluid	7-35		
Checking the washer fluid level	7-35		
Weight/volume	8-5		
Welcome system	4-105		
Headlamp welcome	4-105		
Interior light	4-105		
Puddle lamp and pocket lamp	4-105		
Windows	4-24		
Power windows	4-25		
Windshield defrosting and defogging	4-127		
Automatic climate control system	4-128		
Defogging logic	4-129		
Manual climate control system	4-127		

امداد خودرو فارما

تلفن شبانه روزی: ۰۲۱-۸۸۴۲۰۸۵

FarmSOS.com