

KIA, THE COMPANY



Congratulations! Your selection of a Kia was a wise investment. It will give you years of driving pleasure. Now that you are the owner of a Kia vehicle, you'll probably be asked a lot of questions about your vehicle and the company like "What is a Kia?", "Who is Kia?", "What does 'Kia' mean?".

Here are some answers. First, Kia is the oldest car company in Korea. It is a company that has thousands of employees focused on building high-quality vehicles at affordable prices.

The first syllable, **Ki**, in the word "Kia" means "to arise from to the world" or "to come up out of to the world." The second syllable, **a**, means "Asia." So, the word **Kia**, means "to arise from" or "to come up out of Asia to the world."

Drive safely and enjoy your Kia!

FarmaSOS.com

FOREWORD

Thank you for choosing a Kia vehicle.

When you require service, remember that your dealer knows your vehicle best. Your dealer has factory-trained technicians, recommended special tools, genuine Kia replacement parts and is dedicated to your complete satisfaction.

Because subsequent owners require this important information as well, this publication should remain with the vehicle if it is sold.

This manual will familiarize you with operational, maintenance and safety information about your new vehicle. It is supplemented by a Warranty and Consumer Information manual that provides important information on all warranties regarding your vehicle.

We urge you to read these publications carefully and follow the recommendations to help assure enjoyable and safe operation of your new vehicle.

Kia offers a great variety of options, components and features for its various models.

Therefore, the equipment described in this manual, along with the various illustrations, may not all be applicable to your particular vehicle.

The information and specifications provided in this manual were accurate at the time of printing. Kia reserves the right to discontinue or change specifications or design at any time without notice and without incurring any obligation. If you have questions, always check with your Kia Dealer.

We assure you of our continuing interest in your motoring pleasure and satisfaction in your Kia vehicle.

© 2007 Kia Motors Corp.

All rights reserved. Reproduction by any means, electronic or mechanical, including photocopying, recording, or by any information storage and retrieval system or translation in whole or part is not permitted without written authorization from Kia Motors Corporation.

Printed in Korea

TABLE OF CONTENTS

Introduction	1
Your vehicle at a glance	2
Features of your vehicle	3
Driving your vehicle	4
What to do in an emergency	5
Maintenance	6
Specifications	7
Index	8

امداد خودرو فارما

How to use this manual / 1-2
Fuel requirements / 1-2
Vehicle break-in process / 1-3

تلفن شبانه روزی: ۰۲۱-۸۸۸۶۲۰۸۵

FarmaSOS.com

HOW TO USE THIS MANUAL

We want to help you get the greatest possible driving pleasure from your vehicle. Your Owner's Manual can assist you in many ways. We strongly recommend that you read the entire manual. In order to minimize the chance of death or injury, you must read the WARNING and CAUTION sections spread throughout the manual.

Illustrations complement the words in this manual to best explain how to enjoy your vehicle. By reading your manual, you learn about features, important safety information, and driving tips under various road conditions.

The general layout of the manual is provided in the Table of Contents. A good place to start is the index; it has an alphabetical listing of all information in your manual.

Sections: This manual has seven sections plus an index. Each section begins with a brief list of contents so you can tell at a glance if that section has the information you want.

You'll find various WARNING's, CAUTION's, and NOTICE's in this manual. These were prepared to enhance your personal safety. You should carefully read and follow ALL procedures and recommendations provided in these WARNING's, CAUTION's and NOTICE's.

WARNING

A **WARNING** indicates a situation in which harm, serious bodily injury or death could result if the warning is ignored.

CAUTION

A **CAUTION** indicates a situation in which damage to your vehicle could result if the caution is ignored.

* NOTICE

A **NOTICE** indicates interesting or helpful information is being provided.

FUEL REQUIREMENTS

Your new Kia vehicle is designed to use only unleaded fuel with a minimum Octane Rating of 87 Anti-Knock Index (AKI).

For improved vehicle performance, premium unleaded fuel with an octane rating of AKI 91 or higher is recommended.

CAUTION

NEVER USE LEADED FUEL. The use of leaded fuel is detrimental to the catalytic converter and will damage the engine control system's oxygen sensor and affect emission control.

Never add any fuel system cleaning agents to the fuel tank other than what Kia has specified. (Consult an Authorized Kia Dealer for details.)

Gasoline containing alcohol and methanol

Gasohol, a mixture of gasoline and ethanol (also known as grain alcohol), and gasoline or gasohol containing methanol (also known as wood alcohol) are being marketed along with or instead of leaded or unleaded gasoline.

Do not use gasohol containing more than 10% ethanol, and do not use gasoline or gasohol containing any methanol. Either of these fuels may cause drivability problems and damage to the fuel system. Discontinue using gasohol of any kind if drivability problems occur.

Vehicle damage or drivability problems may not be covered by the manufacturer's warranty if they result from the use of:

1. Gasohol containing more than 10% ethanol.
2. Gasoline or gasohol containing methanol.
3. Leaded fuel or leaded gasohol.

CAUTION

Never use gasohol which contains methanol. Discontinue use of any gasohol product which impairs drivability.

VEHICLE BREAK-IN PROCESS

No special break-in period is needed. By following a few simple precautions for the first 1,000 km (600 miles) you may add to the performance, economy and life of your vehicle.

- Do not race the engine.
- Do not maintain a single speed for long periods of time, either fast or slow. Varying engine speed is needed to properly break-in the engine.
- Avoid hard stops, except in emergencies, to allow the brakes to seat properly.
- Avoid full-throttle starts.

تلفن شبانه روزی: ۰۲۱-۸۸۸۶۲۰۸۵

FarmaSOS.com

Your vehicle at a glance

2

Interior overview / 2-2

Instrument panel overview / 2-3

تلفن شبانه روزی: ۰۲۱-۸۸۸۶۲۰۸۵

FarmaSOS.com

INTERIOR OVERVIEW

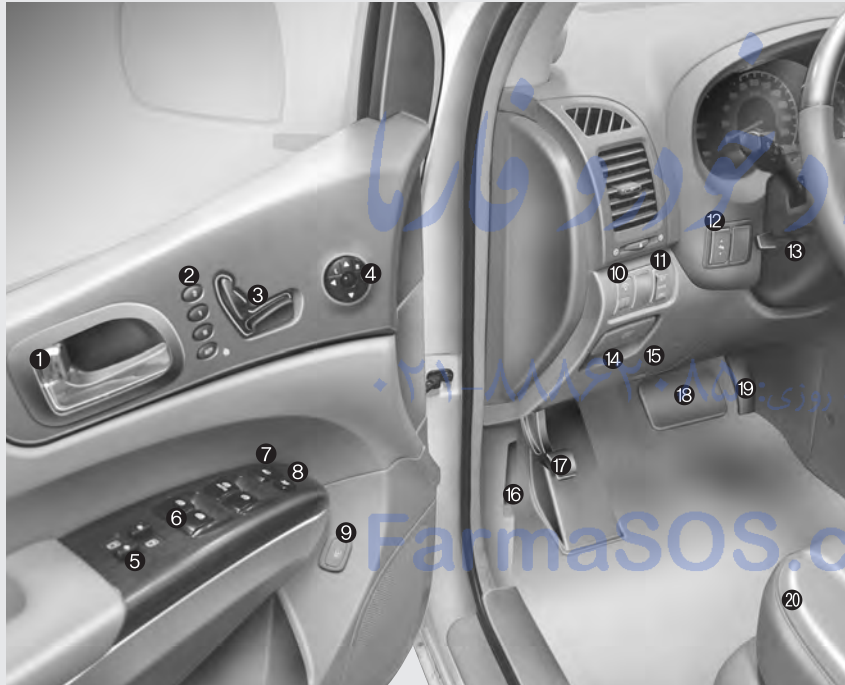

- 1. Door lock/unlock button3-13
- 2. Driver position memory system*3-56
- 3. Seat adjust knob*3-40
- 4. Outside rearview mirror control switch3-103
- 5. Power rear quarter window switches*3-26
- 6. Power window switches3-26
- 7. Central door lock switch3-13
- 8. Power window lock switch3-28
- 9. Fuel filler lid release button3-30
- 10. Instrument panel illumination3-110
- 11. Room light main control switch3-123
- 12. Power adjustable pedal control switch*3-57
- 13. Steering wheel tilt3-101
- 14. Parking brake release lever4-16
- 15. Fuse box6-21
- 16. Hood release lever3-29
- 17. Parking brake pedal4-16
- 18. Brake pedal4-14
- 19. Accelerator pedal4-7
- 20. Seat3-37

* : if equipped

OVQ026001N

INSTRUMENT PANEL OVERVIEW



- 1. Driver's airbag3-87
- 2. Light control / Turn signals3-127
- 3. Instrument cluster.....3-107
- 4. Wiper/Washer3-130
- 5. Auto cruise control*4-11
- 6. Audio controls*3-179
- 7. Steering wheel3-100
- 8. Ignition switch.....4-3
- 9. Digital clock3-178
- 10. Climate control system*3-136
- 11. Hazard warning flasher switch ...3-135
- 12. Seat warmer*3-44
- 13. Shift lever4-5
- 14. Cigar lighter*3-173
- 15. Power outlet.....3-177
- 16. Ashtray*3-173
- 17. Passenger's airbag.....3-88
- 18. Storage compartment.....3-169
- 19. Vent controls.....3-140
- 20. Glove box3-171
- 21. Sunglass holder3-172
- 22. Sunvisor3-176
- 23. Power sliding door and power tailgate controls*.....3-17
- 24. Sunroof*3-33
- 25. Conversation mirror.....3-106
- 26. Trip computer*3-111
- 27. Day/night rearview mirror3-105

* : if equipped

OVQ026002N

Keys / 3-3
Remote keyless entry / 3-4
Theft-alarm system / 3-7
Immobilizer system / 3-9
Door locks / 3-11
Power sliding door and power tailgate / 3-17

Features of your vehicle

3

Window / 3-26
Hood / 3-29
Fuel filler lid / 3-30
Sunroof / 3-33
Seat / 3-37
Driver position memory system / 3-57
Power adjustable pedals / 3-58
Safety belts / 3-59
Child restraint system / 3-71
Air bags-advanced restraint system / 3-78
Steering wheel / 3-101
Mirrors / 3-103
Instrument cluster / 3-108
Gauges / 3-109
Trip computer / 3-112

Warnings and indicators / 3-118
Interior lights / 3-123
Lighting / 3-127
Wipers and washers / 3-130
Horn / 3-133
Defroster / 3-134

3

Features of your vehicle

Hazard warning flasher / 3-135
Manual climate control system / 3-136
Automatic climate control system / 3-147
Windshield defrosting and defogging / 3-160
Luggage net holder / 3-163
Roof rack / 3-164
Homelink® wireless control system / 3-165
Storage compartment / 3-169
Interior features / 3-173
Antenna / 3-179
Audio remote control / 3-179
Audio system / 3-180
Rear seat entertainment system / 3-210

تلفن شبانه روزی: ۰۸۵۰۸۶۲

naSOS.com

KEYS



1VQA2001

The key code number is stamped on the plate attached to the key set. Should you lose your keys, this number will enable an authorized Kia Dealer to duplicate the keys easily. Remove the plate and store it in a safe place. Also, record the code number and keep it in a safe and handy place, but not in the vehicle.

Key operations

Master key

Used to start the engine, lock and unlock the doors, lock and unlock the glove box and center console storage (if equipped).

⚠ WARNING - Ignition key

Leaving children unattended in a vehicle with the ignition key is dangerous even if the key is not in the ignition. Children copy adults and they could place the key in the ignition. The ignition key would enable children to operate power windows or other controls, or even make the vehicle move, which could result in serious bodily injury or even death. Never leave the keys in your vehicle with unsupervised children.

⚠ WARNING

Use only Kia original parts for the ignition key in your vehicle. If an aftermarket key is used, the ignition switch may not return to ON after START. If this happens, the starter will continue to operate causing damage to the starter motor and possible fire due to excessive current in the wiring.

FarmaSOS.com

REMOTE KEYLESS ENTRY (IF EQUIPPED)

Type A



(1) **Lock** (🔒)

All doors are locked if the lock button is pressed.

If all doors are closed, the hazard warning lights blink once to indicate that all doors are locked. However, if any door remains open, the hazard warning lights are not operated. After this, if all door are closed, the hazard warning lights blink.

Type B



(2) **Unlock** (🔓)

Driver's door is unlocked if the unlock button is pressed once.

The hazard warning lights will blink twice to indicate that the driver's door is unlocked.

All doors are unlocked if the unlock button is pressed twice within 3 seconds.

Type C



The hazard warning lights will blink twice again to indicate that all doors are unlocked.

After depressing this button, the doors will be locked automatically unless you open any door within 30 seconds.

(3) **Power tailgate opening or closing** (🔓, if equipped)

The tailgate is opened or closed automatically if the button is pressed. The hazard warning lights will blink and the chime will sound 3 times to indicate that the tailgate will swing upward or downward.

(4) **Left power sliding door opening or closing** (🔓, if equipped)

The left sliding door is opened or closed automatically if the button is pressed.

(5) **Right power sliding door opening or closing** (🔓, if equipped)

The right sliding door is opened or closed automatically if the button is pressed.

*** NOTICE**

The power sliding door and power tailgate are not opened by pressing the corresponding button on the transmitter directly when all power sliding doors and power tailgate are locked and closed. To open the power sliding door or power tailgate from outside vehicle, press the unlock button twice within 3 seconds first and press corresponding power sliding door or power tailgate opening button.

⚡ CAUTION

The power doors can be operated when the engine is not running. However, the power doors consume large amounts of vehicle electric power. To prevent the battery from being discharged, do not operate them consecutively (more than approximately 10 times).

*** NOTICE**

The transmitter will not work if any of following occur:

- The ignition key is in ignition switch.
- You exceed the operating distance limit (about 30 m [90 feet]).
- The battery in the transmitter is weak.
- Other vehicles or objects may be blocking the signal.
- The weather is extremely cold.
- The transmitter is close to a radio transmitter such as a radio station or an airport which can interfere with normal operation of the transmitter.

When the transmitter does not work correctly, open and close the door with the ignition key. If you have a problem with the transmitter, contact an authorized Kia Dealer.

⚡ CAUTION

Keep the transmitter away from water or any liquid. If the keyless entry system is inoperative due to exposure to water or liquids, it will not be covered by your manufacturer vehicle warranty.

Operational distance may vary depending upon the area the transmitter is used in. For example, if the vehicle is parked near police stations, government and public offices, broadcasting stations, military installations, airports, or transmitting towers, etc.

(6) Alarm (📢)

The horn sounds and hazard warning lights flash for about 27 seconds if this button is pressed. To stop the horn and lights, press any button on the transmitter.

Features of your vehicle

This device complies with Industry Canada Standard RSS-210. Operation is subject to the following two conditions:

1. This device may not cause interference, and
2. This device must accept any interference, including interference that may cause undesired operation of the device.

⚠ WARNING

Changes or modifications not expressly approved by the party responsible for compliance could void the user's authority to operate the equipment.



Battery replacement

Transmitter uses a 3 volt lithium battery which will normally last for several years. When replacement is necessary, use the following procedure.

1. Insert a slim tool into the slot and gently pry open the transmitter center cover (1).
2. Replace the battery with new one. When replacing the battery, make sure the battery positive "+" symbol faces up as indicated in the illustration.
3. Install the battery in the reverse order of removal.

For replacement transmitters, see an Authorized Kia Dealer for reprogramming.

*** NOTICE**

The keyless entry system transmitter is designed to give you years of trouble-free use, however it can malfunction if exposed to moisture or static electricity. If you are unsure how to use your transmitter or replace the battery, contact an authorized Kia dealer.

⚠ CAUTION

- *Using the wrong battery can cause the transmitter to malfunction. Be sure to use the correct battery.*
- *To avoid damaging the transmitter, don't drop it, get it wet, or expose it to heat or sunlight.*

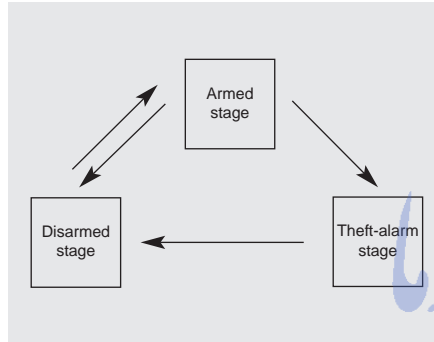
THEFT-ALARM SYSTEM (IF EQUIPPED)

This system is designed to provide protection from unauthorized entry into the car. This system is operated in three stages: the first is the "Armed" stage, the second is the "Theft-alarm" stage, and the third is the "Disarmed" stage. If triggered, the system provides an audible alarm with blinking of the hazard warning lights.

Armed stage

Park the car and stop the engine. Arm the system as described below.

1. Remove the ignition key from the ignition switch.
2. Make sure that all doors, the engine hood and tailgate are closed and latched.
3. Lock the doors using the transmitter of the keyless entry system.

After completion of the steps above, the hazard warning lights will blink once to indicate that the system is armed.

If any door, tailgate or engine hood remains open, the hazard warning lights won't operate and theft-alarm will not arm. After this, if all doors, tailgate and engine hood are closed, the hazard warning lights blink once.

The system can be armed by locking the doors with the key from the front doors or tailgate. However, the hazard warning lights are not operated.

- If any door, tailgate or engine hood remains open, the system will not be armed. If this happens, re-arm the system as described previous.
- Do not arm the system until all passengers have left the vehicle. If the system is armed while a passenger(s) remains in the vehicle, the alarm may be activated when the remaining passenger(s) leave the vehicle. If any door, tailgate or engine hood is opened within 30 seconds after entering the armed stage, the system is disarmed to prevent unnecessary alarm.

Features of your vehicle

Theft-alarm stage

The alarm will be activated if any of the following occurs while the system is armed.

- A front or rear door is opened without using the ignition key or transmitter.
- The tailgate is opened without using the ignition key or transmitter.
- The engine hood is opened.

The siren will sound and the hazard warning lights will blink continuously for 27 seconds, and repeat the alarm 3 times unless the system is disarmed. To turn off the system, unlock the doors with the ignition key or transmitter.

* NOTICE

Avoid trying to start the engine while the alarm is activated. The vehicle starting motor is disabled during the theft-alarm stage.

Disarmed stage

The system will be disarmed when the doors are unlocked by depressing the unlock button on the transmitter or unlocked with the ignition key.

After depressing unlock button, the hazard warning lights will blink twice to indicate that the system is disarmed.

After depressing unlock button, if any door is not opened within 30 seconds, the system will be rearmed.

If the system is not disarmed with the ignition key or transmitter, insert the key in the ignition switch, turn the key to the ON position and wait for 30 seconds. Then the system will be disarmed.

تلفن شبانه روزی: ۰۲۱-۸۸۸۶۲۰۸۵

FarmaSOS.com

IMMOBILIZER SYSTEM (IF EQUIPPED)

Your vehicle is equipped with an electronic engine immobilizer system to reduce the risk of unauthorized vehicle use.

Your immobilizer system is comprised of a small transponder in the ignition key, and antenna coil in the key cylinder and Immobilizer Control Unit (or Smartra Unit).

With this system, whenever you insert your ignition key into the ignition switch and turn it to ON, the antenna coil in the ignition switch receives a signal from the transponder in the ignition key and then sends the signal to the ECU (Engine Control Unit).

The ECU checks the signal whether the ignition key is valid.

If the key is determined to be valid, the engine will start.

If the key is determined to be invalid, the engine will not start.

To deactivate the immobilizer system:

Insert the ignition key into the key cylinder and turn it to the ON position.

To activate the immobilizer system:

Turn the ignition key to the OFF position. The immobilizer system activates automatically. Without a valid ignition key for your vehicle, the engine will not start.

* NOTICE

When starting the engine, do not use the key with other immobilizer keys around. Otherwise the engine may not start or may stop soon after it starts. Keep each key separately not to have any malfunction after you receive your new vehicle.

* NOTICE

If you need additional keys or lose your keys, consult your authorized Kia dealer.

Limp home (override) procedure

When you turn the ignition key to the ON position, if the IMMO indicator goes off after blinking 5 times, your transponder equipped in the ignition key is out of order. You cannot start the engine without the limp home procedure. To start the engine, you have to input your password by using the ignition switch.

The following procedure is how to input your password of "2345" as an example.

1. Turn the ignition key to the ON position. The IMMO indicator () will blink 5 times and go off indicating the beginning of the limp home procedure.
2. Turn the ignition key to the ACC position.
3. To enter the first digit (in this example "2"), turn the ignition key to the ON and ACC position twice. Perform the same procedure for the next digits between 3 seconds and 10 seconds (for example, for "3", turn the ignition ON and ACC 3 times).

Features of your vehicle

4. If all of the digits have been input successfully, you have to start the engine within 30 seconds. If you attempt to start the engine after 30 seconds, the engine will not start and you will have to input your password again.

After performing the limp home procedure, you have to see an authorized Kia dealer immediately to inspect and repair your ignition key or immobilizer system.

CAUTION

The transponder in your ignition key is an important part of the immobilizer system. It is designed to give years of trouble-free service, however you should avoid exposure to moisture, static electricity and rough handling. Immobilizer system malfunction could occur.

CAUTION

Do not change, alter or adjust the immobilizer system because it could cause the immobilizer system to malfunction and should only be serviced by an authorized Kia dealer.

Malfunctions caused by improper alterations, adjustments or modifications to the immobilizer system are not covered by your vehicle manufacturer warranty.

This device complies with Industry Canada Standard RSS-210. Operation is subject to the following two conditions:

1. This device may not cause interference, and
2. This device must accept any interference, including interference that may cause undesired operation of the device.

WARNING

Changes or modifications not expressly approved by the party responsible for compliance could void the user's authority to operate the equipment.

DOOR LOCKS

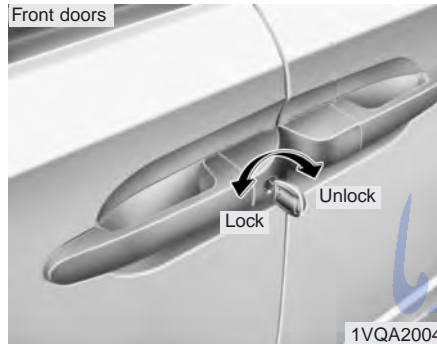

Operating door locks from outside the vehicle

- Turn the key toward rear of vehicle to unlock and toward front of vehicle to lock.
- Turn the key toward front of vehicle to lock all doors.
- Turn the key to the right once to unlock the driver's door and to the right twice within 3 seconds to unlock all doors.
- Turn the key to the left once to unlock the passenger's door and to the left twice within 3 seconds to unlock all doors.

- Doors can also be locked and unlocked with the transmitter key (if equipped).
- Once the doors are unlocked, it may be opened by pulling the door handle.
- When closing the door, push the door by hand. Make sure that doors are closed securely.

* NOTICE

In cold and wet climates, door lock and door mechanisms may not work properly due to freezing conditions.

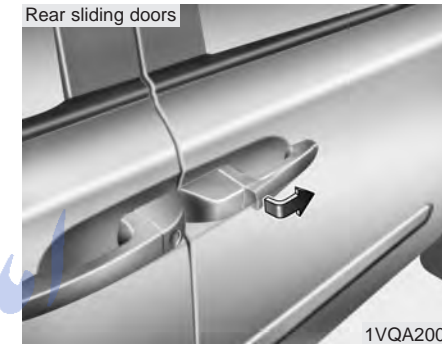

- Once the doors are unlocked, it may be opened by pulling the door handle and sliding the door towards the rear of the vehicle.
- When the door is fully open, the door will lock into an open position. To close the door, pull out the door handle and sliding the door towards the front of vehicle.
- If the window on the rear sliding door is open (more than 80 mm/3 in.), the rear sliding door will not open fully but will open to the 3/4 position.

Features of your vehicle

⚠ WARNING

When the rear sliding door is not fully open, it is not latched and may move unintentionally. This could result in a serious injury.

⚠ CAUTION

The left sliding door cannot be opened when the fuel filler lid is open. However, if the fuel filler lid is opened after the door is opened slightly, the left sliding door can be slide rearward. Close the left sliding door to prevent possible damage to the door or the fuel filler lid.



To lock a door without the key, push the inside door lock button (1) or door lock switch (2) to the "Lock" position and close the door (3).

⚠ WARNING

Always remove the ignition key, engage the parking brake, close all windows and lock all doors when leaving your vehicle unattended.

*** NOTICE**

If the door is locked/unlocked multiple times in rapid succession with either the vehicle key or door lock switch, the system may stop operating temporarily in order to protect the circuit and prevent damage to system components.

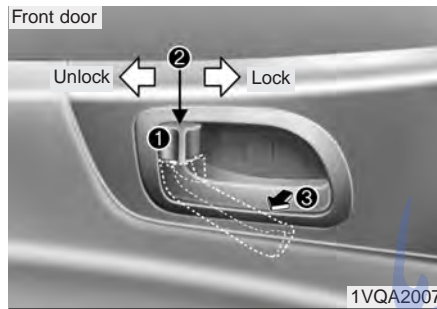

Operating door locks from inside the vehicle

With the door lock button

- To unlock a door, pull the door lock button (1) to the "Unlock" position. If the door is unlocked, the red part (2) of the button becomes visible.

- To lock a door, push the door lock button (1) to the "Lock" position. If the door is locked, red part (2) of the button becomes invisible.
- To open a door, pull the door handle (3).
- If the inner door handle of the front door is pulled when the door lock button is in lock position, the button is unlocked and door opens. (if equipped)
- Front doors cannot be locked if the ignition key is in the ignition switch and door is open.

* NOTICE - Door lock malfunction

If a power door lock ever fails to function while you are in the vehicle, try one or more of the following techniques to exit:

- Operate the door unlock feature repeatedly (both electronic and manual) while simultaneously pulling on the door handle.
- Operate the other door locks and handles, front and rear.
- Lower a front window and use the key to unlock the door from outside.

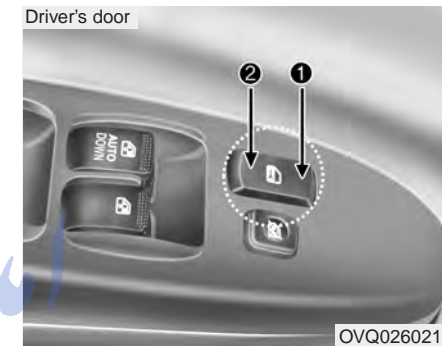

With central door lock switch

The central door locking switch is located on the front door arm rest. It is operated by depressing the door lock switch. If any door is open when the switch is depressed, the door will remain locked when closed.

Features of your vehicle

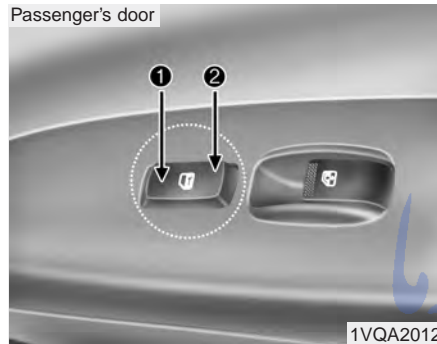

- When pushing down on the front portion (1) of the switch, all vehicle doors will lock.
- When pushing down on the rear portion (2) of the switch, all vehicle doors will unlock.
- However, if the key is in the ignition switch and any front door is open, the doors will not lock when the front portion of central door lock switch is pressed.

⚠ WARNING - Doors

- The doors should always be fully closed and locked while the vehicle is in motion to prevent accidental opening of the door. Locked doors will also discourage potential intruders when the vehicle stops or slows.
- Be careful when opening doors and watch for vehicles, motorcycles, bicycles or pedestrians approaching the vehicle in the path of the door. Opening a door when something is approaching can cause damage or injury.

⚠ WARNING - Unlocked vehicles

Leaving your vehicle unlocked can invite theft or possible harm to you or others from someone hiding in your vehicle while you are gone. Always remove the ignition key, engage the parking brake, close all windows and lock all doors when leaving your vehicle unattended.

⚠ WARNING - Unattended children

An enclosed vehicle can become extremely hot, causing death or severe injury to unattended children or animals who cannot escape the vehicle. Furthermore, children might operate features of the vehicle that could injure them, or they could encounter other harm, possibly from someone gaining entry to the vehicle. Never leave children or animals unattended in your vehicle.



Child-protector rear door lock

The child safety lock is provided to help prevent children from accidentally opening the rear doors from inside the vehicle. The rear door safety locks should be used whenever children are in the vehicle.

1. Open the rear door.
2. Push the child safety lock located on the front edge of the door to the "Lock" position. When the child safety lock is in the "Lock (🔒)" position, rear door will not open when the inner door handle is pulled inside the vehicle or the sub control button of the power sliding door is pressed.

3. Close the rear door.

To open the rear door, pull the outside door handle or push the main control button of the power sliding door.

Even though the doors may be unlocked, the rear door will not open by pulling the inner door handle or pushing the sub control button until rear door child safety lock is unlocked (🔓).

⚠️ WARNING - Rear door locks

If children accidentally open the rear doors while the vehicle is in motion, they could fall out and be severely injured or killed. To prevent children from opening the rear doors from the inside, the rear door safety locks should be used whenever children are in the vehicle.

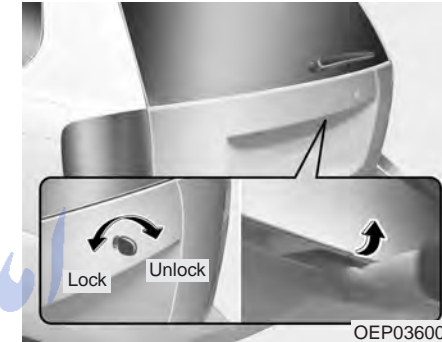

Tailgate

Opening the tailgate

- Tailgate is locked or unlocked with a key.
 - If you lock the tailgate with a key, all doors will lock automatically.
 - If you unlock the tailgate with a key, the tailgate will unlock only.
 - To open the tailgate, insert the key into the lock, turn it to the unlock position and pull up the tailgate by pressing the handle.
- You can also lock/unlock the latch (but not release it) with the central door lock system.
- If unlocked, the tailgate can be opened by pressing the handle and pulling it up.



Closing the tailgate

To close the tailgate, lower and push down the tailgate firmly. Make sure that the tailgate is securely latched.

*** NOTICE**

- In cold and wet climates, door lock and door mechanisms may not work properly due to freezing conditions.
- When jacking up the vehicle to change a tire or repair the vehicle, do not operate the tailgate. This could cause the tailgate to close improperly.

⚠ WARNING - Tailgate

The tailgate swings upward. Make sure no objects or people are near the rear of the vehicle when opening the tailgate.

⚠ CAUTION

Make certain that you close the tailgate before driving your vehicle. Possible damage may occur to the tailgate lift cylinders and attaching hardware if the tailgate is not closed prior to driving.

⚠ WARNING - Exhaust fumes

If you drive with the tailgate open, you will draw dangerous exhaust fumes into your vehicle which can cause serious injury or death to vehicle occupants.

If you must drive with the tailgate open, keep the air vents and all windows open so that additional outside air comes into the vehicle.

⚠ WARNING - Rear cargo area

Occupants should never ride in the rear cargo area where no restraints are available. To avoid injury in the event of an accident or sudden stops, occupants should always be properly restrained.

POWER SLIDING DOOR AND POWER TAILGATE (IF EQUIPPED)

On the overhead console



1VQA2014

On the center pillar trim

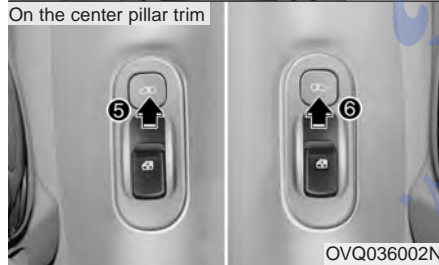

OVQ036002N

On the tailgate



1VQA2016

- (1) Left power sliding door main control button
 - (2) Right power sliding door main control button
 - (3) Power tailgate main control button*
 - (4) Power ON/OFF button
 - (5) Left power sliding door sub control button
 - (6) Right power sliding door sub control button
 - (7) Power tailgate sub control button*
- *: if equipped

The power sliding doors and power tailgate can be opened and closed automatically with the transmitter key, the main control buttons on the overhead console or the sub control buttons on the center pillar trim and the tailgate.

When the power ON/OFF button (PWR) is OFF (not depressed), the power sliding door and power tailgate can be opened and closed manually by pulling the door handles from inside or outside vehicle.

⚠ WARNING

Never leave children or animals unattended in your vehicle. Children or animals might operate the power sliding door or power tailgate that could result in injury to themselves or others or damage to the vehicle.

*** NOTICE**

If the power sliding door or power tailgate is open approximately 6 hours, the ECU will enter Sleep mode to conserve battery power and the door or tailgate might not close automatically. Close the door or tailgate manually and then operate the door or tailgate with the power operating system.

*** NOTICE**

In cold and wet climates, power sliding doors and tailgate may not work properly due to freezing conditions.

*** NOTICE**

When the sliding doors are opened manually (power OFF), more effort will be required to open and close than on non-power sliding doors.

*** NOTICE**

- The power sliding door and power tailgate can be operated when the engine is not running. However the power operation consumes large amounts of vehicle electric power. To prevent the battery from being discharged, do not operate them excessively e.g.: more than approximately 10 times repeatedly.
- To prevent the battery from being discharged, do not leave the power sliding door and power tailgate at open position for a long time.
- Do not apply excessive force while operating the power sliding door or power tailgate. This could cause damage to the power sliding door or power tailgate.
- Do not modify or repair any part of the power sliding door or power tailgate by yourself. This must be done by an authorized Kia dealer.
- When jacking up the vehicle to change a tire or repair the vehicle, do not operate the power sliding door or power tailgate. This could cause the power sliding door or power tailgate to operate improperly.



Automatic stop and reversal

If the power opening or closing is blocked by an object or part of the body, the power sliding door and power tailgate will detect the resistance, then the chime will sound 3 times, and stop movement or move to the full open position to allow the object to be cleared.

However, if the resistance is weak such as an object that is thin or soft, or the door is near latched position, the automatic stop and reversal may not detect the resistance and closing operation will continue. Also, if the power sliding door or power tailgate is forced by strong impact, the automatic stop and reversal may operate.

If the automatic stop and reversal feature operates continuously more than twice during one opening or closing operation, the power sliding door or power tailgate may stop at that position. At this time, close the doors manually and operate the door automatically again.

⚠ WARNING

- Never intentionally place any object or part of your body in the path of the power sliding door or power tailgate to make sure the automatic stop operates.
- Make sure rear passengers are seated and there are no people or objects around the door before operating the power sliding door.
- Make sure all faces, arms, hands, body parts and any other obstructions are safely out of the way before operating the power sliding doors or power tailgate.
- Never place any object or part of your body in the path of the power sliding door or power tailgate. This could result in serious injury or cause damage to the vehicle.
- Make sure there are no people or objects around the door before operating the power sliding door or power tailgate. Have rear passengers or cargo get in or out of the vehicle after the door is open fully and stopped.

On the driver's side fuse panel

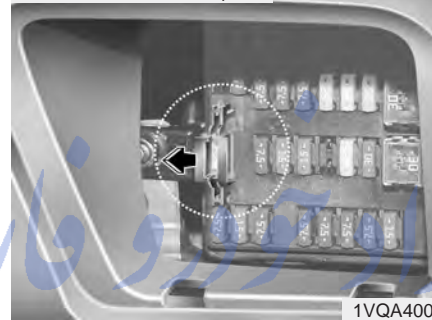

How to reset the power sliding door and power tailgate

If the battery has been discharged or disconnected, the related fuse has been replaced or disconnected, and the power sliding door or power tailgate doesn't work properly, the power sliding door and power tailgate must be reset as follows:

1. Put the shift lever in the P (Park) for automatic transaxle.
2. Close the sliding door's windows and fuel filler lid.

3. Pull the SHUNT connector on the driver's side fuse panel and reinstall it after 1 minute.
4. Close the sliding door or tailgate manually.
5. Open the sliding door or tailgate completely using the transmitter or main control button on the overhead console.
6. Close the sliding door or tailgate completely using the transmitter or main control button on the overhead console.

For the left/right power sliding doors and power tailgate, follow above steps to reset.

If the power sliding door or power tailgate doesn't work properly after above procedure, have the system checked by an authorized Kia dealer.

Features of your vehicle



Power ON/OFF button

- When the power ON/OFF button (PWR) is ON (depressed), the power sliding door and power tailgate can be controlled with the sub control buttons on the center pillar trim or tailgate. Also, the doors can be opened and closed automatically by pulling the inside or outside door handles.

- When the power ON/OFF button (PWR) is OFF (not depressed), the power sliding door and power tailgate can not be controlled with the sub control buttons or door handles. However, the doors can be controlled with the transmitter or the main control buttons on the overhead console even though the power ON/OFF button (PWR) is OFF (not depressed).

Also, the doors can be opened and closed manually by pulling the inside or outside door handles.

⚠ WARNING

Do not allow children to play with the power sliding door or power tailgate. Keep the power ON/OFF button (PWR) in the OFF (not depressed) position when not in use. Serious injury or death can result from unintentional power operation by child.

*** NOTICE**

Close the sliding door and tailgate, and keep the power ON/OFF button (PWR) in the OFF (not depressed) position before washing the vehicle in an automatic car wash.

*** NOTICE**

When the sliding doors are opened manually (power OFF), more effort will be required to open and close than on non-power sliding doors.



Power sliding door operation

- Push the corresponding main control button on the overhead console to open or close the power sliding door. However, the power sliding door will not open with the transmitter or the main control button when all power sliding doors and power tailgate are locked and closed.

- When the power ON/OFF button (PWR) is ON (depressed), do as follows to open or close the power sliding doors:
 - Push the corresponding sub control button on the center pillar trim.
 - Pull the door handle from inside or outside vehicle.
 - If the sub control button is pushed while the door is locked or child safety lock is engaged, the chime sounds once, and the power sliding door will not open.

- If the door handle is pulled from inside or outside while the door is locked or child safety lock is engaged, the power sliding door will not open. However, the power sliding door can be opened by pulling the outside door handle while the door is unlocked and child safety lock is engaged.

- When the power ON/OFF button (PWR) is OFF (not depressed), the power sliding door can not be controlled with the sub control buttons or door handles, and if the sub control button is pushed, chime sounds once. However, the doors can be opened and closed manually by pulling the door handles from inside or outside vehicle.
- On a steep grade, the power sliding door will slide faster when closing. And chime may sound and the drive unit motor may operate additionally for a moment after the door is closed. This is a normal operation to ensure door closing, not a malfunction.



OVQ036004

⚠ WARNING

If your vehicle is facing downward on a steep grade (15 percent or more), the door may not stay open and could slam shut, possibly injuring someone. To make sure the door does not slam shut, turn on the power sliding door feature. Then if the door closes, it will close under the control of the power door system.

⚠ WARNING

If children accidentally open the power sliding doors while the vehicle is in motion, they could fall out and be severely injured or killed. To prevent children from opening the power sliding doors from the inside, the child safety locks should be used whenever children are in the vehicle.

⚠ WARNING

When the rear passenger operates the power sliding door, make sure there are no people or objects around the door, and have all occupants get in or out of the vehicle after the door is open fully and stopped.

⚠ WARNING

- Let the rear passengers get in or out of the vehicle after the door is open fully. Sudden closing could cause a serious injury.
- Close the door by pulling the door handle after the door is open fully. Do not pull the door handle while rear passengers are getting in or out. The door could suddenly close by itself and cause a serious injury.
- Sudden starting or accelerating the vehicle while the door is closing could cause it to open resulting in a serious injury or damage to cargo.

- If the window on the power sliding door is open (more than 80 mm/3 in.), the power sliding door will not power open fully but will open to the 3/4 position and the chime will sound 3 times. To close the door, use the transmitter or main control button with the power ON/OFF button in OFF position (not depressed), or sub control button or door handle with the power ON/OFF button in ON position (depressed).

⚠ WARNING

Do not leave the power sliding door in a partially opened position. Close the window and then open the door fully. A partially opened door is held and then released after 10 minutes. The chime sounds 3 times to indicate the door is released. If the vehicle is stopped on a downward slope, it may move and cause an injury.

- The left power sliding door cannot be opened while the fuel filler lid is open fully. If the main or sub control button is pushed, the chime sounds once. Also, if the fuel filler lid open button is pushed while the left power sliding door is opening, the chime sounds once.

*** NOTICE**

If the fuel filler lid is opened when the left sliding door is not closed completely, the door may be opened. Close the left sliding door before refueling to prevent possible damage to the door or the fuel filler lid.

- If the power sliding door is not closed and latched completely after power closing operation, the chime sounds 3 times. Open and close the door again.
- If the power sliding door is operated while the door is in partially opened position (less than 300 mm/12 in.), the door is automatically opened fully.
- If the power sliding door is operated while the door is in half-opened position (more than 300 mm/12 in.), the door is automatically closed completely.

- If the power sliding door is operated again while the door is closing, the door is automatically opened fully.
- If the power sliding door is operated again while the door is opening, the door is automatically closed completely. However, if the power sliding door is operated again when the door is in partially opened position (less than 300 mm/12 in.), the door is opened continuously.
- The half-opened power sliding door is automatically opened or closed fully by pushing the door forward or backward without pulling the door handle while the power ON/OFF button is in ON (depressed). However, when the door is in partially opened position (less than 300 mm/12 in.), the door is not closed automatically.

Features of your vehicle

Power sliding door non-opening conditions

The power sliding door is not automatically opened, but closed under the following conditions. If the main or sub control button is pushed for power opening operation, the chime sounds once.

When the ignition switch is in the ON position,

1. Vehicle is moving above 5 km/h (3 mph).
2. The gearshift lever is not in P (Park) for automatic transaxle.

⚠ WARNING

Do not open the sliding doors while the vehicle is in motion. Passengers or cargo may be ejected from the vehicle, possibly resulting in property damage, severe injury, or death.

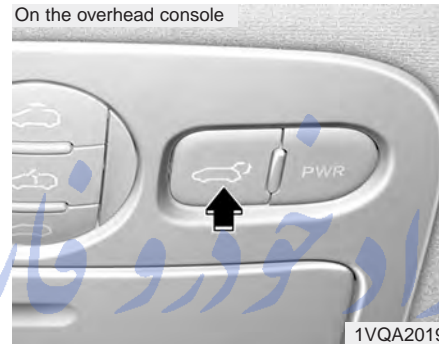

Power tailgate operation (if equipped)

- Push the power tailgate main control button on the overhead console to open or close the power tailgate. However, the power tailgate will not open with the transmitter or the main control button when all power sliding doors and power tailgate are locked and closed.
- When the power tailgate is operated with the main or sub control button or transmitter, the chime sounds and hazard warning lights flash 3 times.

- When the power ON/OFF button (PWR) is ON (depressed), do as follows to open or close the power tailgate:
 - Pushing the sub control button on the bottom of the tailgate will close the power tailgate automatically.
 - Pressing and pulling up the tailgate handle slightly will open the power tailgate automatically when the tailgate is unlocked.

- When the power ON/OFF button (PWR) is OFF (not depressed), the power tailgate can not be controlled with the sub control buttons or tailgate handle, and if the sub control button is pushed, the chime sounds once. However, the tailgate may be opened manually by pulling the exterior handle and lifting the tailgate upward. The tailgate may be manually closed by pushing the tailgate downward.

⚠ WARNING

Even though the power ON/OFF button (PWR) is in the OFF (not depressed) position, the tailgate will still be propelled upward by mechanical force if the tailgate is manually opened more than 20 degrees beyond the fully closed position. In addition, if the tailgate is manually closed to the secondary latch position, the tailgate will be electrically moved to the fully latched position. Make sure that face, arms, hands, and other obstructions are safely out of the way before operating the tailgate.

⚠ WARNING

Make sure there are no people or objects around the tailgate before operating the power tailgate. Wait until the tailgate is open fully and stopped before loading or unloading cargo or passengers from the vehicle.

⚠ WARNING

Make sure the tailgate is closed firmly before driving. If the tailgate is open, you will draw dangerous exhaust fumes into your vehicle which can cause serious injury or death to vehicle occupants.

- If the power tailgate is not closed and latched completely after power closing operation, the chime sounds 3 times.
- If the power tailgate is operated while the tailgate is in partially opened position (less than 20 degrees), the tailgate is automatically opened fully.

If the power tailgate is operated while the tailgate is in half-opened position (more than 20 degrees), the tailgate is automatically closed completely.

- If the power tailgate is operated again while the tailgate is closing, the tailgate is automatically opened fully.
- If the power tailgate is operated again while the tailgate is opening, the tailgate is automatically closed completely. However, if the power tailgate button is pressed again when the tailgate is open less than 20 degrees, the tailgate will continue to open.

Power tailgate non-opening conditions

The power tailgate will not open automatically, but will close under the following conditions. If the main or sub control button is pushed for power opening operation, the chime sounds once.

When the ignition switch is in the ON position,

1. Vehicle is moving above 5 km/h (3 mph).
2. The gearshift lever is not in P (Park) for automatic transaxle.

WINDOWS

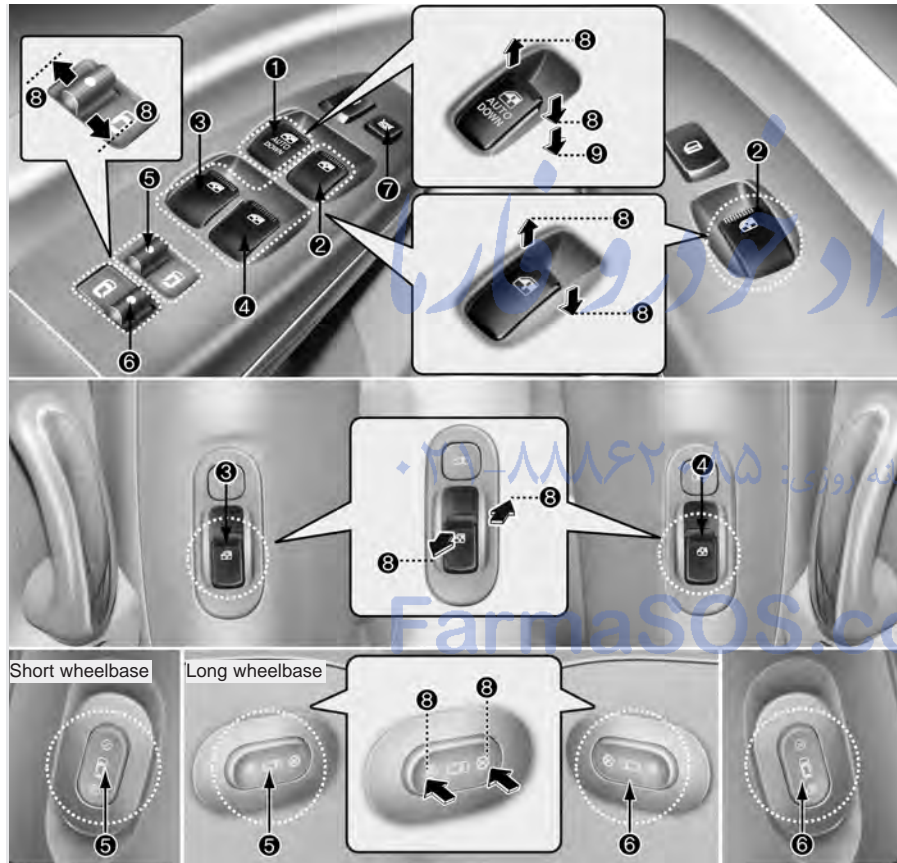

OVQ037005N

Power windows

- (1) Driver's door power window switch
- (2) Front passenger's door power window switch
- (3) Rear door (left) power window switch
- (4) Rear door (right) power window switch
- (5) Power rear quarter window (left) switch*
- (6) Power rear quarter window (right) switch*
- (7) Power window lock switch
- (8) Window opening and closing
- (9) Automatic power window down (Driver's window)

*: if equipped

* NOTICE

In cold and wet climates, power windows may not work properly due to freezing conditions.

The ignition switch must be in the ON position for power windows to operate. Each door has a power window switch that controls that door's window. However, the driver has a power window lock switch which can block the operation of passenger windows.

The power windows can be operated for approximately 30 seconds after the ignition key is removed or turned to the ACC or LOCK position. However, if the front doors are opened, the power windows cannot be operated even within the 30 seconds after the ignition key removal.

While driving, if you notice buffeting and pulsation (wind shock) with either side window open, you should open the opposite window slightly to reduce the condition.

CAUTION

- *To prevent the power window system from the possibility of damage, do not open or close two windows at the same time. This will also ensure the longevity of the fuse.*

(Continued)

(Continued)

- *Never try to operate the main switch on the driver's door and the individual door window switch in opposing directions at the same time. If this is done, the window will stop and cannot be opened or closed.*

WARNING - Windows

- Always double check to make sure all arms, hands, head and other obstructions are safely out of the way before closing a window.
- Do not allow children to play with the power windows. Keep the driver's door power window lock switch in the LOCK position (depressed). Serious injury can result from unintentional window operation by the child.
- Do not extend face or arms outside through the window opening while driving.

Window opening and closing

The driver's door has a master power window switch that controls all the windows in the vehicle.

- To open or close a window, press down (8) or pull up (8) the front portion of the corresponding switch.
- To open or close a rear quarter window, push (8) the corresponding switch.

Features of your vehicle

Automatic power window down (driver's window)

Depressing the power window switch momentarily to the second detent position (9) completely lowers the driver's window even when the switch is released. To stop the window at the desired position while the window is in operation, pull up the switch momentarily to the opposite direction of the window movement.

If the power window is not operated correctly, the automatic power window system must be reset as follows:

1. Turn the ignition key to ON position.
2. Close driver's window and continue pulling up on driver's power window switch for at least 1 second after the window is completely closed.

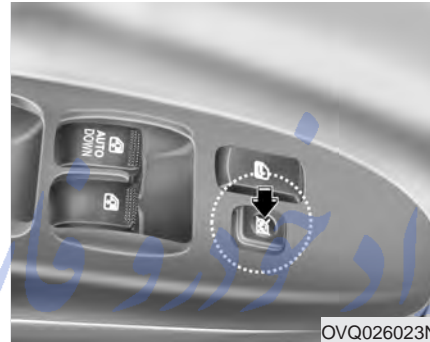

Power window lock switch

- The driver can disable the power window switches on a passenger door or rear quarter trim by depressing the power window lock switch, located on the driver's door to LOCK (pressed).
- **When the power window lock switch is ON, the driver's master control cannot operate the passenger door power windows or rear quarter windows either.**

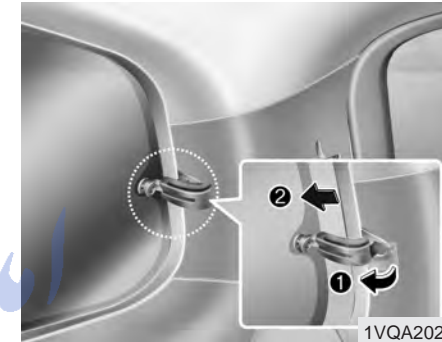

Manual flip - open (rear quarter windows, if equipped)

To open the quarter windows, pull the rear portion of the latch out. Swing the latch forward and out, then lock it into the open position by pushing outward until you hear a click. To close the windows, pull the handle inward. Then push the handle rearward until you hear a click.

* NOTICE

In cold and wet climates, rear quarter panel windows may not work properly due to freezing conditions.

HOOD

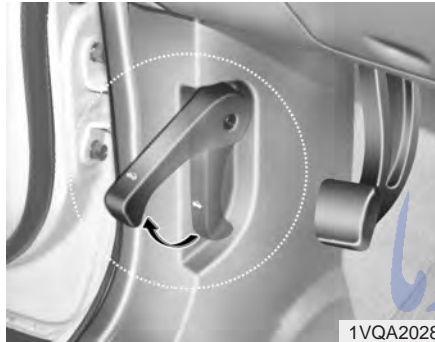

Opening the hood

1. Pull the release lever to unlatch the hood. The hood should pop open slightly.

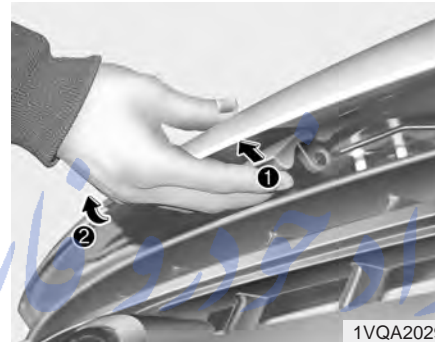

2. Go to the front of the vehicle, raise the hood slightly, pull the secondary latch (1) inside of the hood center and lift (2) the hood.
3. Raise the hood. It will raise completely by itself after it has been raised about halfway.

Closing the hood

1. Before closing the hood, check the following:
 - All filler caps in engine compartment must be correctly installed.
 - Gloves, rags or any other combustible material must be removed from the engine compartment.
2. Lower the hood halfway and push down to securely lock in place.

⚠ WARNING

Make sure the hood is properly locked before driving.

⚠ WARNING - Hood

- Before closing the hood, ensure that all obstructions are removed from the hood opening. Closing the hood with an obstruction present in the hood opening may result in property damage or severe personal injury.
- Do not leave gloves, rags or any other combustible material in the engine compartment. Doing so may cause a heat-induced fire.

FUEL FILLER LID

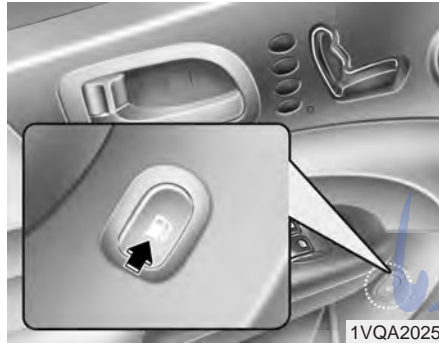

1. Stop the engine.
2. To open the fuel filler lid, push the release button located on the driver's lower door.

⚠ WARNING

To avoid injury from sharp edges, it is recommended that protective gloves be worn if there is a need to open the fuel filler door manually.



3. Pull the fuel filler lid out to open.
4. To remove the cap, turn the fuel tank cap counterclockwise.
5. Refuel as needed.
6. To install the cap, turn it clockwise until it "clicks". This indicates that the cap is securely tightened.
7. Close the fuel filler lid and push it lightly and make sure that it is securely closed.

⚠ WARNING - Refueling

If pressurized fuel sprays out, it can cover your clothes or skin and thus subject you to the risk of fire and burns. Always remove the fuel cap carefully and slowly. If the cap is venting fuel or if you hear a hissing sound, wait until the condition stops before completely removing the cap.

⚠ WARNING - Refueling dangers

Automotive fuels are flammable materials. When refueling, please note the following guidelines carefully. Failure to follow these guidelines may result in severe personal injury, severe burns or death by fire or explosion.

- Before refueling note the location of the Emergency Gasoline Shut-Off, if available, at the gas station facility.
- Before touching the fuel nozzle, you should eliminate potentially dangerous static electricity discharge by touching another metal part of the vehicle, a safe distance away from the fuel filler neck, nozzle, or other gas source.

(Continued)

(Continued)

- Do not get back into a vehicle once you have begun refueling since you can generate static electricity by touching, rubbing or sliding against any item or fabric (polyester, satin, nylon, etc.) capable of producing static electricity. Static electricity discharge can ignite fuel vapors resulting in rapid burning. If you must re-enter the vehicle, you should once again eliminate potentially dangerous static electricity discharge by touching a metal part of the vehicle, away from the fuel filler neck, nozzle or other gasoline source.
- When using a portable fuel container be sure to place the container on the ground prior to refueling. Static electricity discharge from the container can ignite fuel vapors causing a fire. Once refueling has begun, contact with the vehicle should be maintained until the filling is complete.

(Continued)

(Continued)

Use only portable plastic fuel containers designed to carry and store gasoline.

- Do not use cellular phones while refueling. Electric current and/or electronic interference from cellular phones can potentially ignite fuel vapors causing a fire.
- When refueling, always shut the engine off. Sparks produced by electrical components related to the engine can ignite fuel vapors causing a fire. Once refueling is complete, check to make sure the filler cap and filler door are securely closed, before starting the engine.
- DO NOT use matches or a lighter and DO NOT SMOKE or leave a lit cigarette in your vehicle while at a gas station especially during refueling. Automotive fuel is highly flammable and can, when ignited, result in fire.

(Continued)

(Continued)

- If a fire breaks out during refueling, leave the vicinity of the vehicle, and immediately contact the manager of the gas station and then contact the local fire department or 911. Follow any safety instructions they provide.

CAUTION

- *Make sure to refuel with unleaded fuel only.*
- *Check to make sure the fuel filler cap is securely closed after refueling. A loose fuel filler cap may cause the "Check Engine" (Malfunction Indicator) light in the instrument panel to illuminate unnecessarily.*
- *If the fuel filler cap requires replacement, use only a genuine Kia cap or the equivalent specified for your vehicle. An incorrect fuel filler cap can result in a serious malfunction of the fuel system or emission control system.*
- *Do not spill fuel on the exterior surfaces of the vehicle. Any type of fuel spilled on painted surfaces may damage the paint.*
- *If the fuel filler lid will not open in cold weather because the area around it is frozen, push or lightly tap the lid.*



When fuel filler lid does not open with the release button

If the fuel filler lid does not open using the remote fuel filler lid release, you can open it manually. Unsnap and remove the panel in the cargo area. Pull the handle outward.

SUNROOF (IF EQUIPPED)



1VQA2030

- (1) Slide button
- (2) Tilt button
- (3) Close button

If your vehicle is equipped with this feature, you can slide or tilt your sunroof with the sunroof control buttons located on the overhead console.

* NOTICE

In cold and wet climates, sunroof may not work properly due to freezing conditions.

The sunroof can only be opened, closed, or tilted when the ignition switch is in the ON position.

The sunroof can be operated for approximately 30 seconds after the ignition key is removed or turned to the ACC or LOCK position. However, if the front door is opened, the sunroof cannot be operated even within the 30 seconds after the ignition key is removed or turned to the ACC or LOCK position.

CAUTION

Do not continue to press the sunroof control button(s) after the sunroof is in the fully open, closed, or tilt position(s). Damage to the motor or system components could occur.

* NOTICE

The sunroof cannot slide when it is in the tilt position nor can it be tilted while in an open or slide position.



1VQA2031



1VQA2032

Sliding the sunroof

Features of your vehicle

Open

Autoslide

To use the autoslide feature, momentarily (less than 0.4 second) press the slide button on the overhead console.

The sunroof will slide all the way open. To stop the sunroof sliding at any point, press any sunroof control button.

Manual slide

Press the slide button on the overhead console and hold it until the sunroof is opened to the desired position.

Close

To close the sunroof, press the close button on the overhead console and hold it until the sunroof is closed.



Tilting the sunroof

Open

Autotilt

To use the autotilt feature, momentarily (less than 0.4 second) press the tilt button on the overhead console. The sunroof will tilt all the way open. To stop the sunroof tilting at any point, press any sunroof control button.

Manual tilt

Press the tilt button on the overhead console and hold it until the sunroof is opened to the desired position.

Close

To close the sunroof, press the close button on the overhead console and hold it until the sunroof is closed.



1VQA2039

Sunshade

The sunshade will be opened with the glass panel automatically when the glass panel is slid. You will have to close it manually if you want it closed.

CAUTION

- Do not press any sunroof control button longer than necessary. Damage to the motor or system components could occur.
- Periodically remove any dirt that may accumulate on the guide rail.
- If you try to open the sunroof when the temperature is below freezing or when the sunroof is covered with snow or ice, the glass or the motor could be damaged.
- The sunroof is made to slide together with sunshade. Do not leave the sunshade closed while the sunroof is open.



1VQA2036

In case of an emergency

If the sunroof does not open electrically:

1. Open the conversation mirror cover.

WARNING - Sunroof

- Do not extend face, neck, arms or body outside through the sunroof opening while driving.
- Make sure hand and face are safely out of the way before closing a sunroof.

ParmaSOS.com



Resetting the sunroof

Whenever the vehicle battery is disconnected or discharged, or you use the emergency handle to operate the sunroof, you have to reset your sunroof system as follows:

1. Turn the ignition key to the ON position.
 2. According to the position of the sunroof, do as follows:
 - 1) in case that the sunroof has closed completely or been tilted :
Press the tilt button until the sunroof has tilted upward completely.
 - 2) in case that the sunroof has slide-opened:
Press and hold the close button (for more than 5 seconds) until the sunroof has closed completely. Press the tilt button until the sunroof has tilted upward completely.
 3. Release the tilt button.
2. Remove the two (2) screws, and then remove the overhead console.
 3. Insert the emergency handle (provided with the vehicle) and turn the handle clockwise to open or counterclockwise to close.

4. Press and hold the tilt button (for more than 10 seconds) until the sunroof has returned to the original position of tilt after it is raised a little higher than the maximum tilt position. Then, release the button.
5. Press and hold the tilt button (for more than 5 seconds) until the sunroof is operated as follows;

TILT DOWN → SLIDE OPEN → SLIDE CLOSE

Then, release the button.

When this is complete, the sunroof system is reset.

SEAT

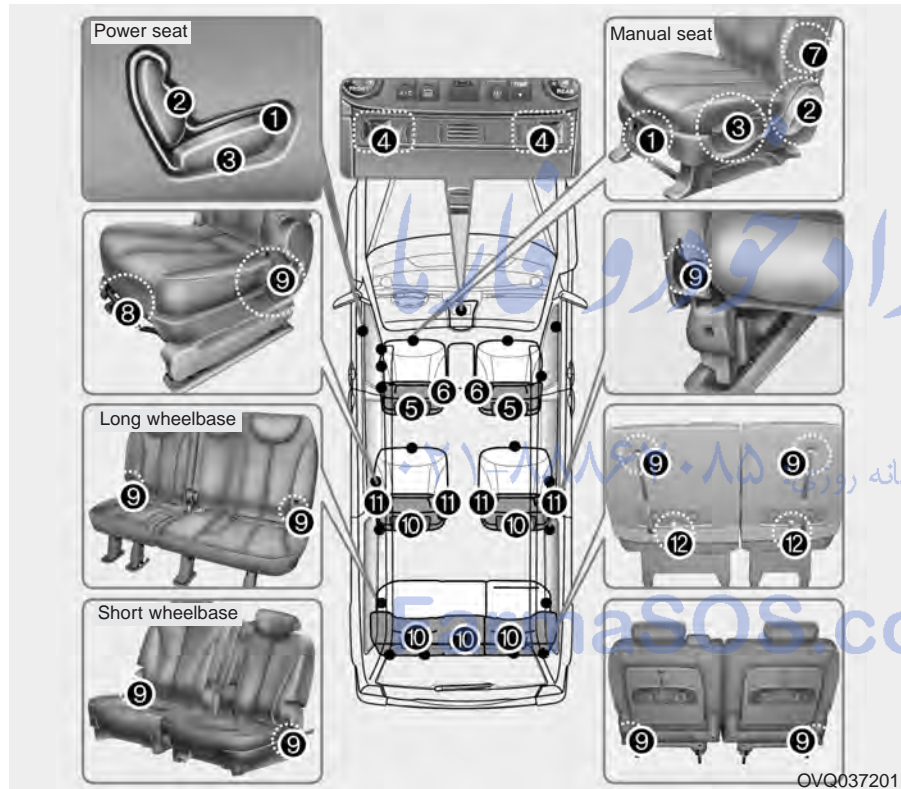

Front seat

- (1) Forward and backward
- (2) Seatback angle
- (3) Seat cushion height (Driver's seat)*
- (4) Seat warmer*
- (5) Headrest
- (6) Armrest
- (7) Lumbar support

Rear seats

- (8) Forward and backward (Long wheelbase)*
- (9) Seatback angle
- (10) Headrest
- (11) Armrest
- (12) Stowing (Long wheelbase)*

* if equipped

⚠ WARNING - Loose objects
 Loose objects in the driver's foot area could interfere with the operation of the foot pedals, possibly causing an accident. Do not place anything under the front seats.

⚠ WARNING - Loose objects
Loose objects in the driver's foot area could interfere with the operation of the foot pedals, possibly causing an accident. Do not place anything under the front seats.

⚠ WARNING - Uprighting seat
When you return the seatback to its upright position, hold the seatback and return it slowly and be sure there are no other occupants around the seat. If the seatback is returned without being held and controlled, the back of the seat could spring forward resulting in accidental injury to a person struck by the seatback.

⚠ WARNING - Driver's seat

- Never attempt to adjust seat while the vehicle is moving. This could result in loss of control, and an accident causing death, serious injury, or property damage.
- Do not allow anything to interfere with the normal position of the seatback. Storing items against a seatback or in any other way interfering with proper locking of a seatback could result in serious or fatal injury in a sudden stop or collision.

(Continued)

(Continued)

- Always drive and ride with your seatback upright and the lap portion of the safety belt snug and low across the hips. This is the best position to protect you in case of an accident.
- In order to avoid unnecessary and perhaps severe airbag injuries, always sit as far back as possible from the steering wheel so that your chest is at least 250 mm (10 inches) away from the steering wheel.

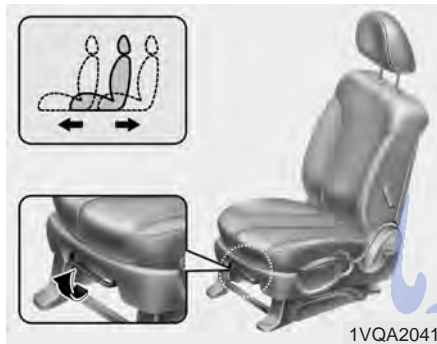

Front seat adjustment - manual

Forward and backward

To move the seat forward or backward:

1. Pull the seat slide adjustment lever under the front edge of the seat cushion up and hold it.
2. Slide the seat to the position you desire.
3. Release the lever and make sure the seat is locked in place.

Adjust the seat before driving, and make sure the seat is locked securely by trying to move forward and backward without using the lever. If the seat moves, it is not locked properly.

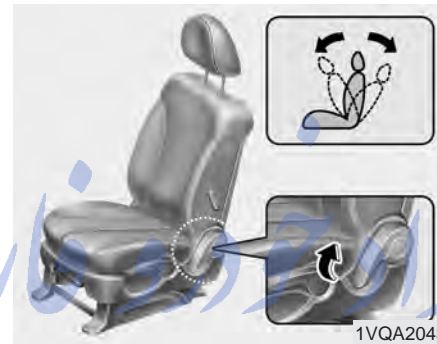

Seatback angle

To recline the seatback:

1. Lean forward slightly and lift up on the seatback recline lever located on the outside of the seat, at the rear.
2. Carefully lean back on the seat and adjust the seatback of the seat to the position you desire.
3. Release the lever and make sure the seatback is locked in place. (The lever MUST return to its original position for the seatback to lock.)

⚠ WARNING - Driver responsibility for front seat passenger

Riding in a vehicle with a front seatback reclined could lead to serious or fatal injury in an accident. If a front seat is reclined during an accident, the occupant's hips may slide under the lap portion of the safety belt applying great force to the unprotected abdomen. Serious or fatal internal injuries could result. The driver must advise the front passenger to keep the seatback in an upright position whenever the vehicle is in motion.

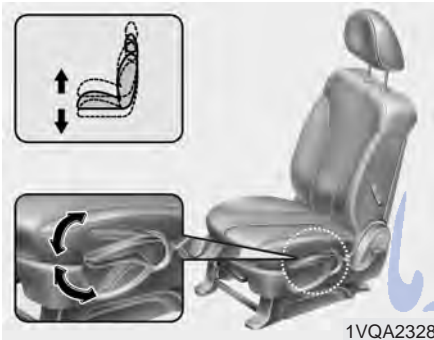

Seat cushion height (for driver's seat)

To change the height of the seat cushion, push the lever up or down located on the outside of the seat cushion.

- To lower the seat cushion, push down the lever several times.
- To raise the seat cushion, pull up the lever several times.



Front seat adjustment - power

The front seat can be adjusted by using the control knob on the front door. Before driving, adjust the seat to the proper position so as to easily control the steering wheel, pedals and switches on the instrument panel.

CAUTION

- Power seats are driven by an electric motor. Stop operating once the adjustment is completed. Excessive operation may damage the electrical equipment.
- When in operation, the power seats consume large amounts of electrical power. To prevent unnecessary charging system drain, don't adjust the power seats longer than necessary while the engine is not running.
- Do not operate two or more power seat control buttons at the same time. Doing so may result in power seat motor or electrical component malfunction.

WARNING

The power seats are operable with the ignition OFF. Therefore, children should never be left unattended in the car.

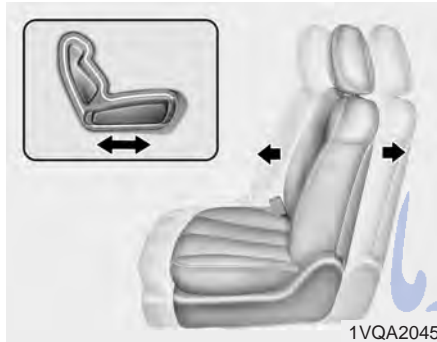

Forward and backward

Push the control knob forward or backward to move the seat to the desired position. Release the knob once the seat reaches to the desired position.

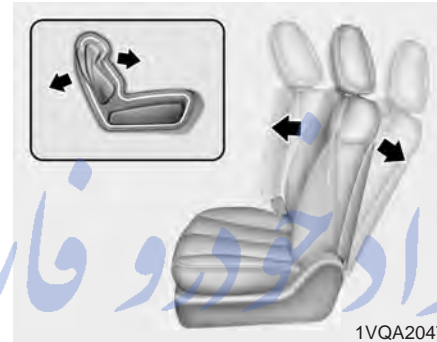

Seatback angle

Push the control knob forward or backward to move the seatback to the desired angle. Release the knob once the seat reaches to the desired position.

⚠ WARNING - Driver responsibility for front seat passenger

Riding in a vehicle with a front seatback reclined could lead to serious or fatal injury in an accident. If a front seat is reclined during an accident, the occupant's hips may slide under the lap portion of the safety belt applying great force to the unprotected abdomen. Serious or fatal internal injuries could result. The driver must advise the front passenger to keep the seatback in an upright position whenever the vehicle is in motion.

Features of your vehicle

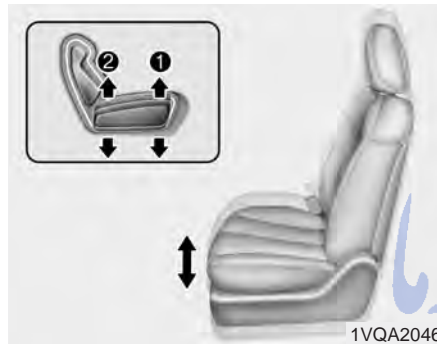

Seat cushion height

Push the front portion (1) of the control knob up to raise or down to lower the front part of the seat cushion. Push the rear portion (2) of the control knob up to raise or down to lower the rear part of the seat cushion. Release the knob once the seat reaches to the desired position.



Headrest (front)

The headrest not only provides comfort for the driver and front passenger, but also helps to protect the head and neck in the event of a collision. For best protection, adjust the headrest so its center is as high as your ears. Also adjust the headrest so its distance from the head is as wide as your fist.

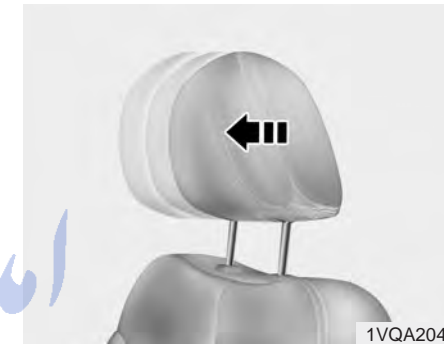

Forward and backward adjustment (if equipped)

The headrest may be adjusted forward to three different positions by pulling the headrest forward. To adjust the headrest backward, pull it fully forward to the farthest position and release it. Adjust the headrest so that it properly supports the head and neck.

Active headrest (if equipped)

The active headrest is designed to move forward and upward during a rear impact. This helps to prevent the driver's and front passenger's head from moving backward and thus helps prevent neck injuries.

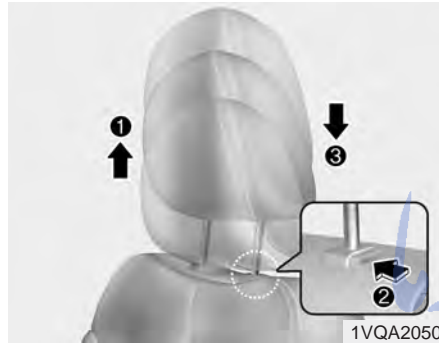

Adjusting the height up and down

To raise the headrest, pull it up to the desired position (1). To lower the headrest, push and hold the release button (2) on the headrest support and lower the headrest to the desired position (3).

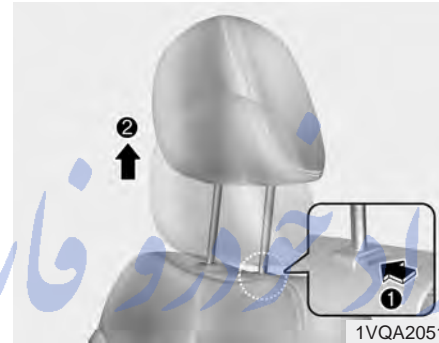

Removal

To remove the headrest, raise it as far as it can go then press the release button (1) while pulling upward (2).

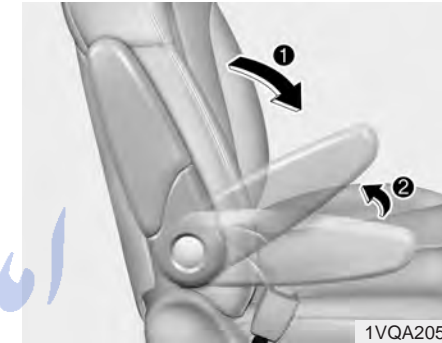

Armrest

The front seats have the armrest located on the side of seatback.

Type A

To use the armrest, swing down the armrest to the lowest position.

Type B

To use the armrest, swing down the armrest to the lowest position then pull it up to the desired position.

⚠ WARNING - Headrest positioning

To reduce the risk of head and neck injuries, each occupant headrest must be properly adjusted. Do not drive the vehicle with the headrest removed or improperly positioned.

Do not adjust the driver's headrest while driving, or else loss of control and an accident is possible.

Features of your vehicle



Seatback pocket

A seatback pocket is provided on the back of the front passenger and drivers seatbacks.

⚠ WARNING - Seatback pockets

Do not put heavy or sharp objects in the seatback pockets. In an accident they could come loose from the pocket and injure vehicle occupants.

⚠ CAUTION

For proper operation of the occupant classification system:

- Do not place any items cumulatively weighing over 1 kg (2.2 lbs) in the seatback pocket or on the seat.
- Do not hang onto the front passenger seat.



* The location of the seat warmer switch may be changed depending on your model.

Seat warmer (if equipped)

The front seats can be electrically heated individually when the ignition switch is ON. When the switch is ON, a number ranging from 1 to 5 is displayed on the switch (5 = warmest setting).

To turn off the seat warmer, set the switch to 0.

The seat warmer turns off automatically when the seat temperature reaches the selected range and will turn on again if the temperature drops below the selected range.

CAUTION

- When cleaning the seats, do not use an organic solvent such as thinner, benzene, alcohol and gasoline. Doing so may damage the surface of the heater or seats.
- To prevent overheating the seat warmer, do not place blankets, cushions or seat covers on the seats while the seat warmer is in operation.
- Do not place heavy or sharp objects on seats equipped with seat warmers. Damage to the seat warming components could occur.

WARNING - Seat heater burns

Passengers should use extreme caution when using seat warmers due to the possibility of excess heating or burns. In particular, the driver must exercise extreme care for the following types of passengers:

1. Infants, children, elderly or handicapped persons, or hospital outpatients
2. Persons with sensitive skin or those that burn easily
3. Fatigued individuals
4. Intoxicated individuals
5. Individuals taking medication that can cause drowsiness or sleepiness (sleeping pills, cold tablets, etc.)

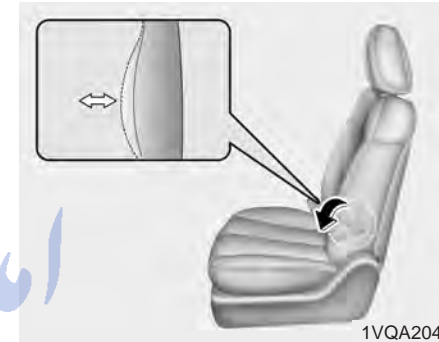

1VQA2042

Lumbar support (driver's seat only)

You can adjust the lumbar support by moving the lever on the outside of the driver's seatback. Pivoting the lever increases or decreases the lumbar support.

Features of your vehicle



Rear seat adjustment

Adjusting the seat forward and backward

- 2nd row seat (Long wheelbase)

To move the seat forward or backward:

1. Pull the seat slide adjustment lever under the front edge of the seat cushion up and hold it.
2. Slide the seat to the position you desire.
3. Release the lever and make sure the seat is locked in place.

Adjust the seat before driving, and make sure the seat is locked securely by trying to move forward and backward without using the lever. If the seat moves, it is not locked properly.

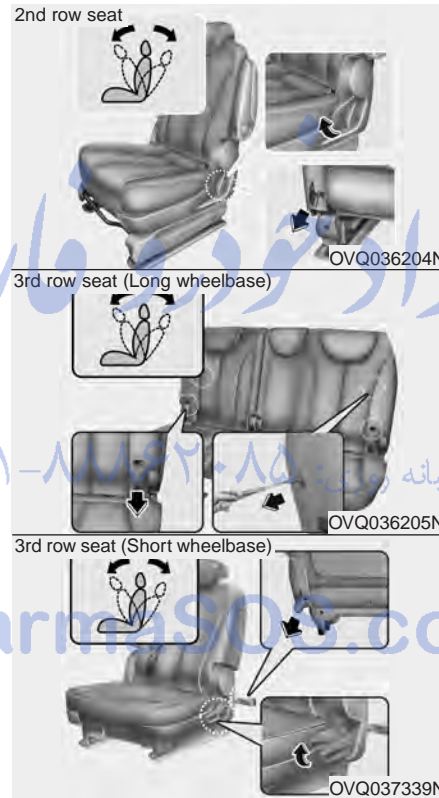

Seatback angle

To recline the seatback:

1. Lean forward slightly and lift up on the seatback recline lever (or strap) located on the outside of the seat at the rear.
2. Carefully lean back on the seat and adjust the seatback of the seat to the position you desire.
3. Release the lever (or strap) and make sure the seatback is locked in place. (The lever MUST return to its original position for the seatback to lock.)



OVQ036206N

Armrest

The 2nd row seats have the armrest located on the side of seatback. To use the armrest, swing down the armrest to the lowest position.

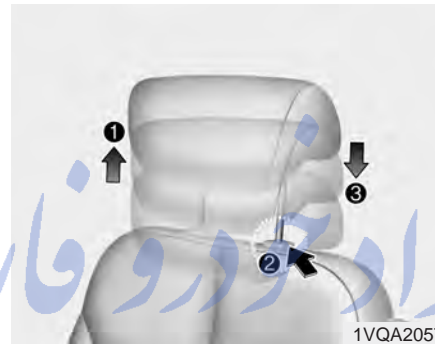

1VQA2057

Headrest (rear)

The headrest not only provides comfort for the passengers, but also helps to protect the head and neck in the event of a collision. For best protection, adjust the headrest so its center is as high as your ears.

Adjusting the height up and down

To raise the headrest, pull it up to the desired position (1). To lower the headrest, push and hold the release button (2) on the headrest support and lower the headrest to the desired position (3).

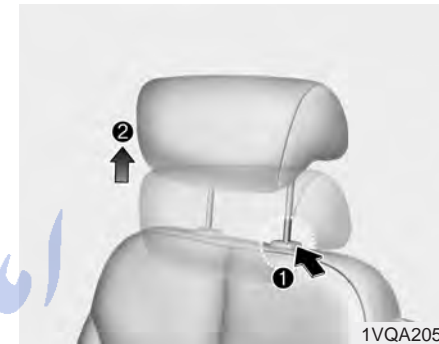

1VQA2058

Removal

To remove the headrest, raise it as far as it can go then press the release button (1) while pulling upward (2).

⚠ WARNING

To reduce the risk of head and neck injuries, do not drive the vehicle with the headrest removed or improperly positioned.

Features of your vehicle

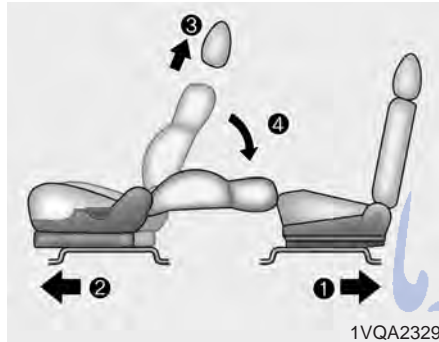

Full flat seat

When the vehicle is parked, you can place the front seat in a reclined position, nearly flat.

1. Move the rear seat to the farthest rearward position.
2. Move the front seat to the farthest forward position.
3. Remove the headrest.
4. Recline the seatback as far as it can go to allow the rear seat passenger to support their legs in the reclined position.

⚠ WARNING - Uprighting seat

When you return the seatback to its upright position, hold the seatback and return it slowly. If the seatback is returned without holding it, the back of the seat could spring forward resulting in accidental injury from being struck by the seatback.

⚠ WARNING - Full flat seat

Never allow a passenger to use the full flat seat feature while the vehicle is in motion because severe injury or death could occur in an accident.

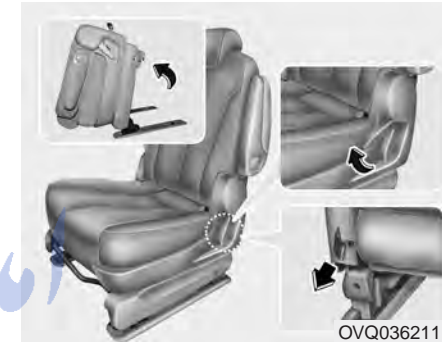

Folding the rear seatback

The rear seatbacks fold forward to provide additional cargo space and to provide access to the cargo area.

To fold the rear seat:

- 2nd row seat
- 3rd row seat (Short wheelbase)

1. Lower the headrest to the lowest position.



2. Pull the seatback recliner (or strap) and double-fold the seat forward.
3. Push down the seat backward firmly to lock the catches into the rear anchors until an audible "click" is heard.

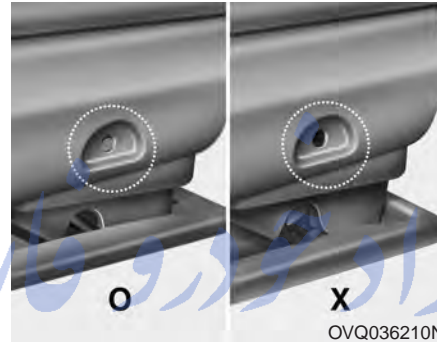

4. Make sure the green mark on the rear seat cushion frame is visible and the catches are locked in position by moving the seat forward and backward or lifting the front portion of the seat. If the green mark is invisible and the seat moves, it is not locked properly.

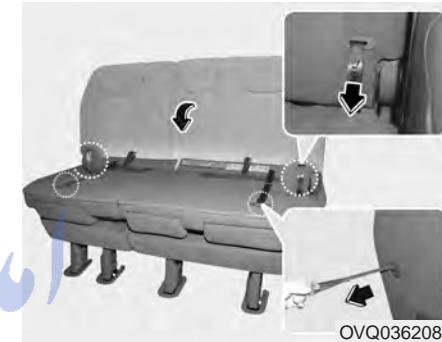

- 3rd row seat (Long wheelbase)

1. Lower the headrest to the lowest position.
2. Hold the seatback and pull out the folding strap.
3. Fold the seatback forward and down firmly until it clicks into place.

To unfold the rear seat:

1. Pull up the seatback recline lever (or strap).
2. Lift and push the seatback backward firmly until it clicks into place.
Make sure the seatback is locked in place.
3. Return the rear safety belt to the proper position.

Features of your vehicle



3rd row seat (Short wheelbase)



Double-folding the rear seat - 2nd row seat - 3rd row seat (Short wheelbase)

To fold the rear seat:

1. Lower the headrest to the lowest position.
2. Move the seat to rear-most position.
3. Double-fold the rear seat forward by pull up the seatback recline lever (or strap).

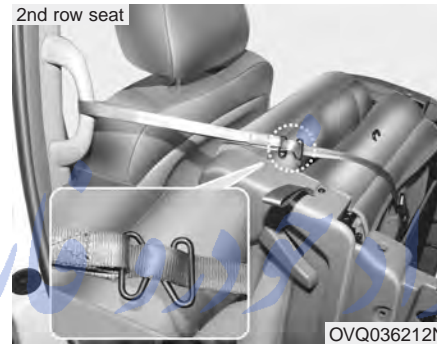

4. Pull the folding strap out of the pocket located under the seat cushion. (2nd row seat)

5. Lift the entire folded seat forward and tie the folded seat to the assist handle using the strap. (2nd row seat)



To unfold the rear seat

1. Untie the strap from the assist handle and insert the strap into the pocket. (2nd row seat)
2. Push down the seat backward firmly to lock the catches into the rear anchors until an audible "click" is heard.

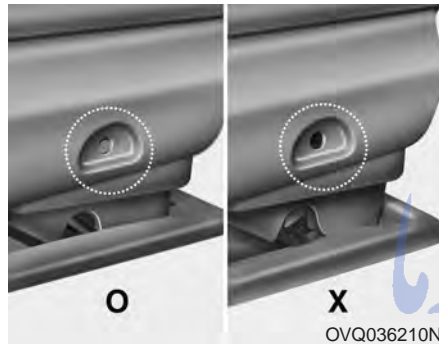

OVQ036210N

3. Make sure the green mark on the rear seat cushion frame is visible and the catches are locked in position by moving the seat forward and backward or lifting the front portion of the seat. If the green mark is invisible and the seat moves, it is not locked properly.
4. Pull up the seatback recline lever (or strap).
5. Lift and push the seatback backward firmly until it clicks into place. Make sure the seatback is locked in place.
6. Return the rear safety belt to the proper position.

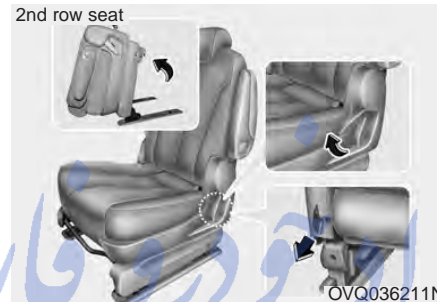

3rd row seat (Short wheelbase)

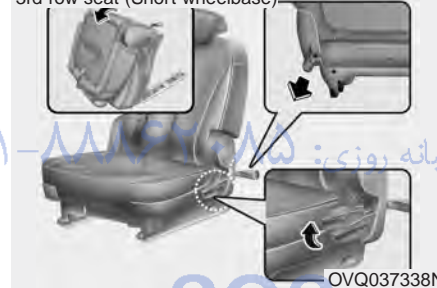

Removing the rear seat

- 2nd row seat

- 3rd row seat (Short wheelbase)

To remove a rear seat:

1. Double-fold the rear seat forward by pulling up the seatback recline lever (or strap).



3rd row seat (Short wheelbase)



2. 2nd row seat

Pull up the catch release lever under the front of the seat cushion while reclining the folded seat rearward slightly to release the front catches from the anchors.

Features of your vehicle

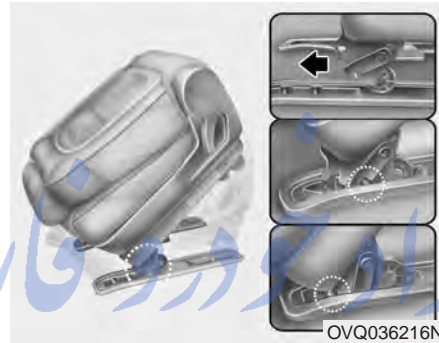
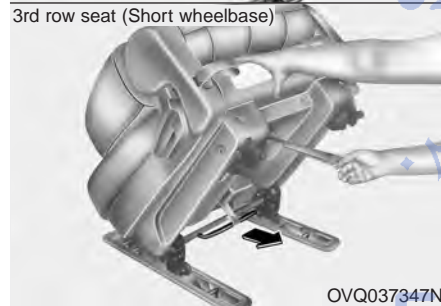
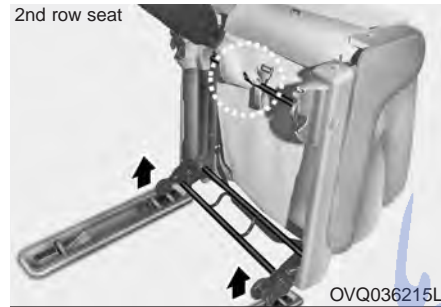

To install the rear seat:

1. Put the front anchor strikers along the front anchors on the floor.
2. Insert two front anchor strikers into the front anchors.
3. Lift the rear portion of the seat cushion then push down firmly to lock the catches into the rear anchors until an audible "click" is heard.

3rd row seat (Short wheelbase)

Pull out the catch release strap under the rear of the seat cushion to release the front catches from the anchors.

* NOTICE

Only use the strap to remove the seat.

3. Remove the entire seat from the floor.

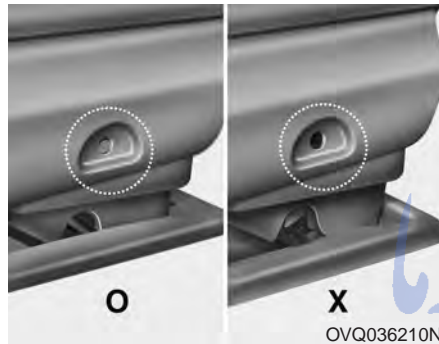

OVQ036210N

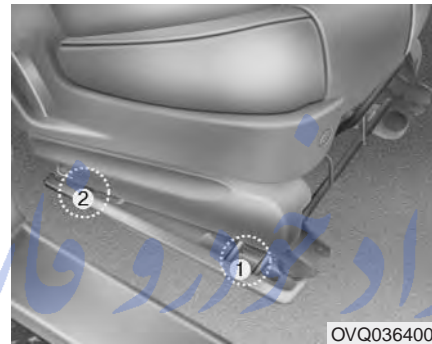

OVQ036400L

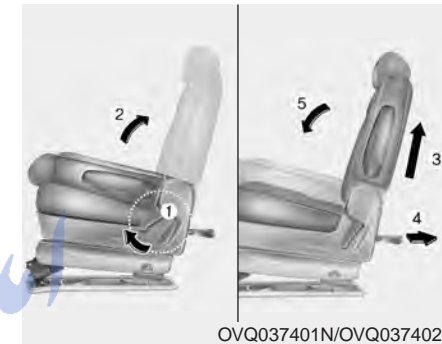

OVQ037401N/OVQ037402N

4. Make sure the green mark on the rear seat cushion frame is visible and the catches are locked in position by moving the seat forward and backward or lifting the front portion of the seat. If the green mark is invisible and the seat moves, it is not locked properly.
5. Pull up the seatback recline lever (or folding strap).
6. Lift and push the seatback backward firmly until it clicks into place.
Make sure the seatback is locked in place.
7. Return the rear seat belt to the proper position.

If the rear catches of the seat are locked into the rear anchors (2) while the front catches are not locked into the front anchors (1), do the followings to release the rear catches from the rear anchors.

1. Lift the seatback (2) while pulling up the seatback recline lever (1) and push the seatback backward firmly until it clicks into place. Be careful not to fold the seat backward because the front catches are not locked.
2. Pull out the seatback recline strap (3) while lifting up the rear portion of the seat cushion (4).
3. Then the seatback will be folded forward and rear catches will be released (5).

Features of your vehicle



4. Remove the seat while lifting up the rear portion of seat cushion (6).

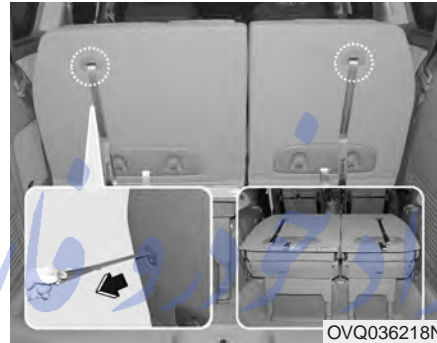

Stowing the rear seat - 3rd row seat (Long wheelbase)

The rear seat can be folded and stowed in the luggage compartment to provide additional cargo space.

To stow the rear seat:

1. Lower the headrest to the lowest position.
2. Fold the seatback by pulling out the folding strap.



3. Pull the seat by using the stowing strap.
4. Stow the seat by pushing down firmly.

⚠ WARNING

- Make sure there is no body or object around the seat and be careful not to injure your hands or body under the seat or in the moving parts when stowing or reinstalling the seat.
- Do not sit on the seat stowed with the seatback upright in the luggage compartment. Sitting on the unstable and unlocked seat could cause serious injuries in an accident.



To use the rear seat:

1. Lift the seat by pulling out the stowing strap.



2. Release the strap and push the seat forward firmly until it clicks into place to insert the catches into the anchors.

*** NOTICE**

Do not push down the upper part of the seatback when pushing the seat forward. Doing so can prevent the catches from being locked in position.



3. Make sure the catches are locked in position by moving the seat forward and backward or lifting the front portion of the seat. If the seat moves, it is not locked properly.
4. Pull out the folding strap.
5. Lift and pull the seatback backward firmly until it clicks into place. Make sure the seatback is locked in place.
6. Return the rear safety belt to the proper position.

Features of your vehicle

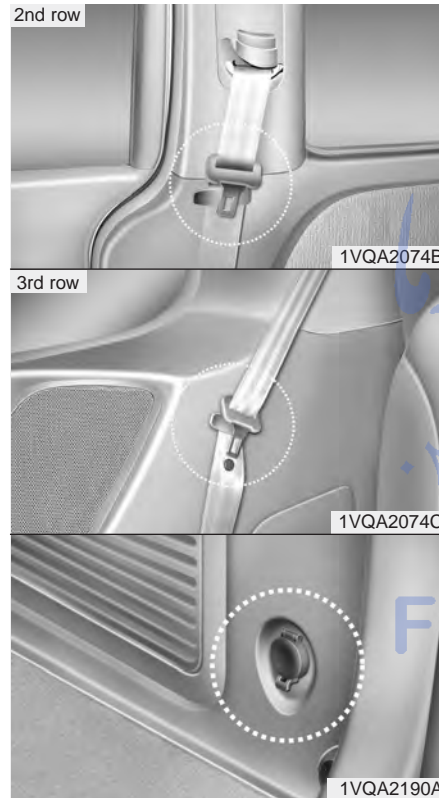

CAUTION

Before changing seat position, slip the seat belt into the trim panel and close the power outlet cap.

CAUTION - Rear safety belts

When returning the rear seatbacks to the upright position, remember to return the rear shoulder belts to their proper position. Routing the safety belt webbing through the rear safety belt guides will help keep the belts from being trapped behind or under the seats.

CAUTION - Avoid damaging rear safety buckles

When you fold the rear seatback or put luggage on the rear seat cushion, insert the buckle in the pocket between the rear seatback and cushion. Doing so can prevent the buckle from being damaged by the rear seatback or luggage.

WARNING - Cargo

Cargo should always be secured to prevent it from being thrown about the vehicle in a collision and causing injury to the vehicle occupants. Special care should be taken of objects placed in the rear seats, since those may hit the front seat occupants in a frontal collision.

WARNING - Cargo loading

Make sure the engine is off, the transaxle is in P and the parking brake is applied whenever loading or unloading cargo. Failure to take these steps may allow the vehicle to move if shift lever is inadvertently moved to another position.

DRIVER POSITION MEMORY SYSTEM (IF EQUIPPED)

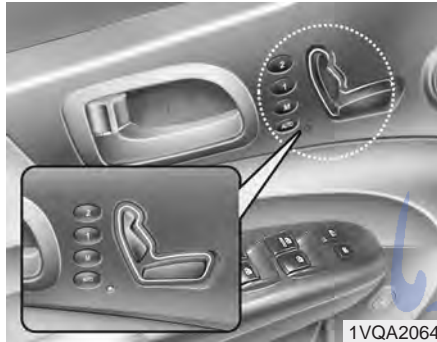

A driver position memory system is provided to store and recall the driver seat, outside rearview mirror and adjustable pedal positions with a simple button operation. By saving the desired positions into the system memory, different drivers can reposition the driver seat, outside rearview mirror and adjustable pedal based upon their driving preference.

If battery is disconnected, the position memory will be lost and the driving positions should be restored in the system.

⚠ WARNING

Never attempt to operate the driver position memory system while the vehicle is moving.

This could result in loss of control, and an accident causing death, serious injury, or property damage.

Storing positions into memory using the buttons on the door

Storing driver's seat positions

1. Shift the transaxle lever into P while the ignition switch is ON.
2. Adjust the driver seat, outside rearview mirror and adjustable pedal to positions comfortable for the driver.
3. Press M button on the control panel. The system will beep once.
4. Press one of the memory buttons (1 or 2) within 5 seconds after pressing the M button. The system will beep twice when memory has been successfully stored.

Recalling positions from memory

1. Shift the transaxle lever into P while the ignition switch is ON.
2. To recall the position in memory, press the desired memory button (1 or 2). The system will beep once, then the driver seat, outside rearview mirror and adjustable pedal will automatically adjust to the stored positions.

Adjusting one of the control knobs for the driver seat, outside rearview mirror and adjustable pedal while the system is recalling the stored positions will cause the movement for that component to stop and move in the direction that the control knob is moved. Other components will continue position recalling.

⚠ WARNING

Use caution when recalling adjustment memory while sitting in the vehicle. Push the seat position control knob to the desired position immediately if the seat moves too far in any direction.

Storing and recalling with transmitter

Storing with the transmitter

Remove the key from the ignition switch and lock all the doors using the transmitter. The driver seat, outside rearview mirror and adjustable pedal positions will be stored in the system memory.

Driver's position recalling with transmitter

Unlock the door with the transmitter, positions stored in the system memory will be recalled automatically.

* NOTICE

The buzzer sounds 10 times if there is a malfunction of the memory system. Have the driver position memory system checked by an authorized Kia dealer.

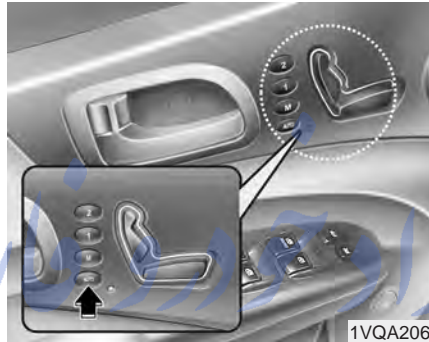

1VQA2065

Easy access function

When the AUTO button is ON (the indicator light illuminates) with the shift lever in P position, the system will move the driver's seat forward or rearward automatically so you can comfortably enter and exit the vehicle.

- It will move driver's seat rearward when the ignition key is removed.
- It will move driver's seat forward when the ignition key is inserted.

POWER ADJUSTABLE PEDALS (IF EQUIPPED)

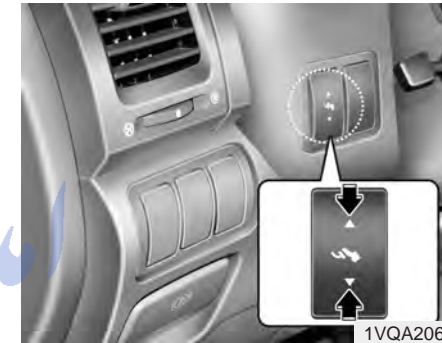

1VQA2066

To adjust the position of the accelerator and brake pedals, push the switch with the shift lever in the P position.

If you push the ▲ portion of the switch, the pedals move toward the driver.

If you push the ▼ portion of the switch, the pedals move away from the driver.

Setting the adjustable pedal position

1. Be sure the parking brake is engaged.
2. Move the accelerator and brake pedals to the front most position by pushing the ▼ portion of the switch.
3. Adjust the seat position and the steering wheel angle properly.
4. Move the pedals toward you until you can fully depress the brake pedal by pushing the ▲ portion of the switch.
5. Depress the pedals a few times to get used to the feel after adjusting.

⚠ WARNING

- Adjust the pedals after parking the vehicle on level ground. Never attempt to adjust the pedals while the vehicle is moving.
- Never adjust the pedals with your foot on the accelerator pedal as this may result in increasing the engine speed and acceleration.
- Make sure that you can fully depress the brake pedal before driving. Otherwise, you may not be able to hold down the brake pedal firmly in an emergency stop.

SAFETY BELTS

Safety belt restraint system

⚠ WARNING - Safety belts

To minimize the risk of serious or fatal injury in an accident, the driver and all passengers should use the appropriate safety restraints for their age and size. The presence of air bags does not change the need to be properly restrained by a safety belt or size-appropriate child restraint. In fact, air bags are designed to work the best when passengers are correctly restrained in the vehicle.

- Be sure you are familiar with the information in this section, including the information on infant and child restraints.
- Read the safety warnings on the sun visors of your vehicle also.

We strongly recommend that the driver and all passengers be properly restrained at all times by using the safety belts provided with the vehicle. Proper use of the safety belts decreases the risk of severe injury or death in accidents or sudden stops. In most states, and in Canada, the law requires their use.

All seats have lap/shoulder belts. Inertial locks in the safety belt retractors allow all of the lap/shoulder safety belts to remain unlocked during normal vehicle operation. This allows the occupants some freedom of movement and increased comfort while using the safety belts. If a force is applied to the vehicle, such as a strong stop, a sharp turn, or a collision, the safety belt retractors will automatically lock the safety belts.

Since the inertial locks do not require a collision in order to lock up, you may become aware of the safety belts locking while braking or going around sharp corners.

Always use the rear seat position(s) to install your child restraint(s).

⚠ WARNING - Child restraint in front seat

Never install a child restraint system in the front passenger position, as an inflating air bag could cause serious or fatal injury to a child in that position.

Features of your vehicle

The rear (or front passenger) safety belts use a special auto-lock feature designed to allow a child restraint to be used in these positions without an added locking clip. They normally lock only under extreme or emergency conditions (emergency lock mode). However they can be adjusted so that they remain fixed and locked when a child restraint system is placed in these positions. (Use this auto-lock mode only to secure a child restraint, never for passengers restrained by the safety belts.)

The drivers safety belt can only operate in the emergency lock mode.

Safety belts provide the best restraint when:

- The seatback is upright.
- The occupant is sitting upright (not slouched).
- The lap belt is snug across the hips.
- The shoulder belt is snug across the chest.
- The knees are straight forward.

⚠ WARNING - After a collision

- Lap/shoulder belt assemblies may be stretched or damaged when subjected to the stress and forces of a collision.
- The entire restraint system should be inspected following any collision. All belts, retractors, anchors and hardware damaged by a collision should be replaced before the vehicle is operated again.

⚠ WARNING - Cargo area

Passengers should never be allowed to ride in the cargo area of a vehicle. No safety belts are provided for the cargo area. Persons riding in the vehicle without a fastened safety belt are much more likely to suffer serious bodily injury or death during an accident.

⚠ WARNING - Twisted belts

A twisted or jammed safety belt cannot restrain you properly. If you cannot untwist or unjam the safety belt, have an authorized Kia dealer service it immediately. Never drive or ride with a twisted or jammed safety belt.

⚠ WARNING - Belt use

Safety belts must be used correctly to work properly in an accident. Each seating position in your vehicle has a specific safety belt assembly that includes a buckle and tongue designed to be used together.

Failure to heed these warnings and follow these instructions will increase the risk and severity of injuries and the likelihood of death in an accident.

(Continued)

(Continued)

- Use the shoulder portion of the safety belt on the outside shoulder only. Never wear the shoulder portion under the arm or place it between your back and seatback.
- Never swing the safety belt around your neck to fit over the inside shoulder.
- Never wear the shoulder portion of the safety belt across the neck or face.
- Wear the lap portion as low as possible. Be sure that the lap belt fits snugly around the hips. Never wear a lap portion of a lap/shoulder belt over your waist; it should always go over the stronger area of your hips.
- Never use a single safety belt for more than one person.
- The front seatbacks should always remain in a comfortable, upright position when the vehicle is moving.

⚠ WARNING - Safety belt care

- A damaged belt may not give you the protection you need in an accident.
- Inspect your safety belts periodically for excessive wear or damage. Pull out each belt fully and look for fraying, cuts, burns or other damage. Pull the safety belt out and let it retract a number of times. Make sure that the lap/shoulder belts return smoothly and easily into the retractor.
- Check the latches to make sure they latch and release without interference or delay.
- Never close the doors on any part of the lap or shoulder belt.
- Any belt not in good condition or in good working order should be promptly replaced.

⚠ WARNING

Never close the doors on any part of the lap or shoulder belt. It can damage the safety belt or buckle which could increase the risk of injury in case of an accident.



Safety belt warning light and chime

If the driver's safety belt is not fastened when the key is turned ON or if it is disconnected after the key is turned ON, the safety belt warning light will blink until the belt is fastened.

If the driver's safety belt is not fastened when the key is turned ON or if it is unfastened after the key is ON, the safety belt warning chime will sound for approximately 6 seconds.

Features of your vehicle



Lap/shoulder belt

To fasten the lap/shoulder belt:

1. Grasp the buckle and tongue plate.
2. Slowly pull the lap/shoulder belt out from the retractor.

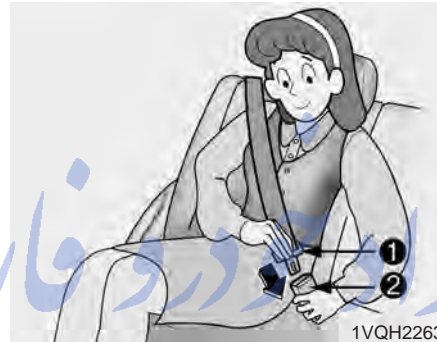

3. Insert the tongue plate (1) into the open end of the buckle (2) until an audible “click” is heard, indicating the belt is locked in the buckle.

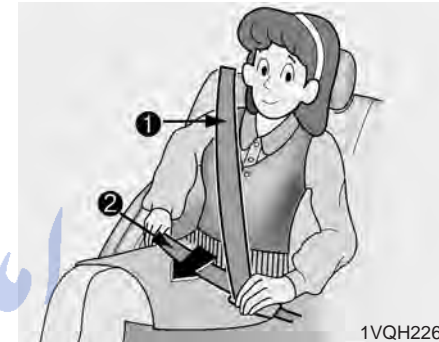

4. Position the lap portion (2) of the belt across your lap as **LOW ON THE HIPS** as possible to reduce the risk of sliding under it during an accident. Adjust the belt to a **SNUG FIT** by pulling up on the shoulder portion (1) of the safety belt. The belt retractor is designed to take up excess webbing automatically and to maintain tension on the belt. For your safety, do not put any excess slack into the safety belt at any location.

FarmaSOS.com

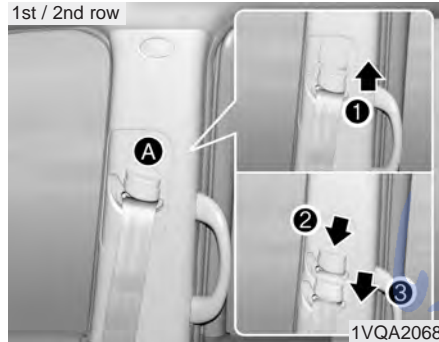

⚠ WARNING

- The height adjuster must be in the locked position when the vehicle is moving.
- The misadjustment of height of the shoulder belt could reduce the effectiveness of the seat belt in a crash.

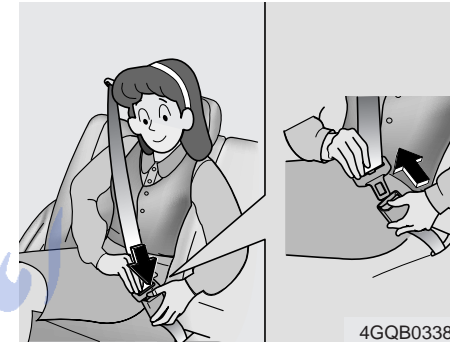

5. Adjust the shoulder anchor position to your size. To raise the anchor position, push the anchor up (1). To lower the anchor position, press (2) the button (A) and slide the anchor down (3). After adjustment, make sure the anchor is locked in position. (if equipped)

If the height of the adjusting seat belt is too near your neck, you will not be getting the most effective protection. The shoulder portion should be adjusted so that it lies across your chest and midway over your shoulder nearest the door and not your neck.

To unfasten the lap/shoulder belt:
Press the release button on the buckle and allow the belt to slowly retract.

تلفن شبانه روزی: ۰۸۵-۸۸۶۲۰۱۱
ArmaSOS.com

Features of your vehicle



3 Point rear center belt - 3rd row (Long wheelbase)

To fasten the rear center belt

1. Extract the tongue plate from the hole on the belt assembly cover and slowly pull the tongue plates out from the retractor.

CAUTION - Cargo

Be sure that the cargo is securely loaded in the rear cargo area. Failing to do so may damage the rear center safety belt in sudden stop or certain collisions.

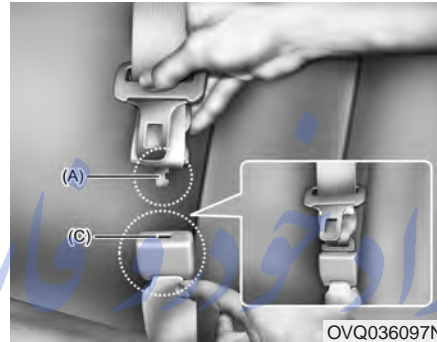

2. Insert the tongue plate (A) into the open end of the buckle (C) until an audible "click" is heard, indicating the latch is locked. Make sure the belt is not twisted.

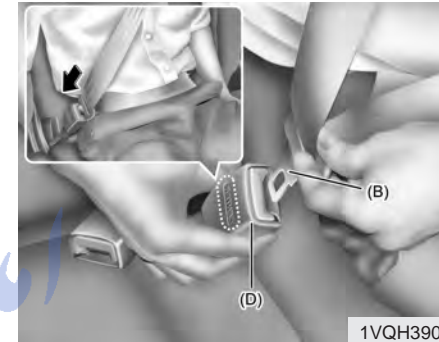

3. Pull the tongue plate (B) and insert the tongue plate (B) into the open end of the buckle (D) until an audible "click" is heard, indicating the latch is locked. Make sure the belt is not twisted.

There will be an audible “click” when the tab locks in the buckle. The safety belt automatically adjusts to the proper length only after the lap belt is adjusted manually so that it fits snugly around your hips, if you lean forward in a slow, easy motion, the belt will extend and let you move around. If there is a sudden stop or impact, the belt will lock into position. It will also lock if you try to lean forward too quickly.

⚠ WARNING

When using the rear safety center belt, you must lock all tongue plates and buckles. If any tongue plate or buckle is not locked, it will increase the chance of injury in the event of collision.

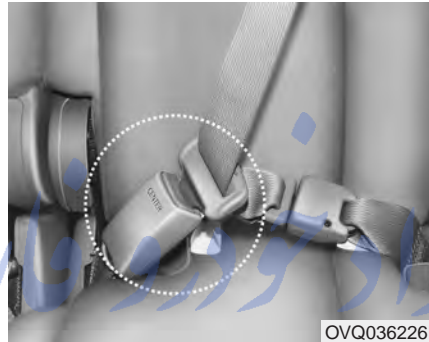

When using the rear center seat belt, the buckle with the “CENTER” mark must be used.

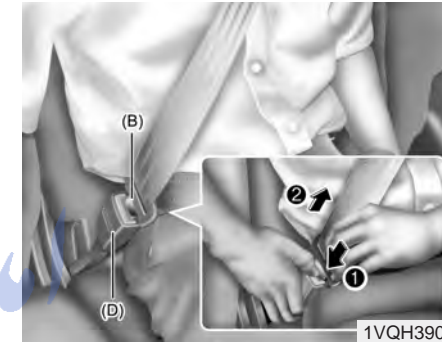

To unfasten the rear center belt

1. Press the release button on the buckle (D) and remove the tongue plate (B) from the buckle (D).
2. Retract the rear center seatbelt.

Features of your vehicle

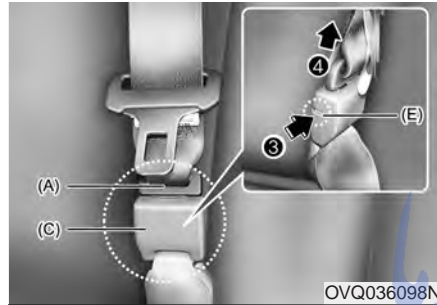

3. Insert the key or similar small rigid device into the web release button (E) on the anchor connector. Pull up on the seat belt web (A) and allow the webbing to retract automatically.
4. Insert the tongue plate (A) into the hole on the belt assembly cover.

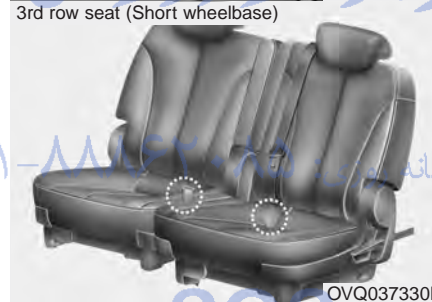
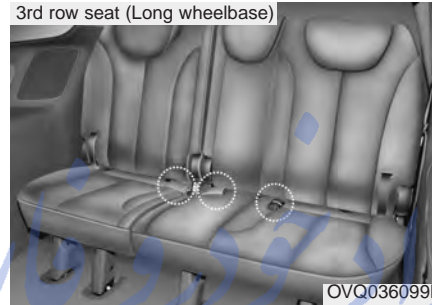

Stowing the rear safety belt

The rear safety belt can be stowed in the pocket between the rear seatback and cushion when not in use.

Proper use and care of the safety belt system

To ensure that the safety belts provide the maximum protection, please follow these instructions:

- Use the belts at all times - even on short trips.
- If the safety belt is twisted, straighten it prior to use.
- Keep sharp edges and damaging objects away from the belts.
- Periodically inspect belt webbing, anchors, buckles and all other parts for signs of wear and damage. Replace damaged, excessively worn or questionable parts immediately.
- To clean the belt webbing, use a mild soap solution recommended for cleaning upholstery or carpets. Follow the instructions provided with the soap.
- Do not make modifications or additions to the safety belt.
- After wearing a safety belt, make sure it fully retracts to the stowed position. Do not allow the belt to get caught in the door when you close it.

⚠ WARNING - Belt cleaning
Do not bleach or dye the webbing because this may weaken the webbing fibers and cause them to fail when restraining an occupant in a collision.

Restraint women

Pregnant women should wear lap/shoulder belt assemblies whenever possible according to specific recommendations by their doctors. The lap portion of the belt should be worn AS SNUGLY AND LOW AS POSSIBLE.

⚠ WARNING - Pregnant women
Pregnant women must never place the lap portion of the safety belt over the area of the abdomen where the fetus is located or above the abdomen where the belt could crush the fetus during an impact.

Infants and small children

To increase their safety, infants and young children should always be restrained by a restraint system approved for their age and size.

Never allow a child to stand or kneel on the seat of a moving vehicle. Never allow a safety belt to be placed around both a child and an adult or around two children at the same time.

It is best for children to be seated in the rear seats.

Many companies manufacture child restraint systems (often called child seats) for infants and small children. An acceptable child restraint system must always satisfy Canadian Motor Vehicle Safety Standards. Make sure that any child-restraint system you use in your vehicle is labelled as complying with Federal Safety Standards.

The child-restraint system should be chosen to fit both the size of the child and the size of the vehicle seat. Be sure to follow any instructions provided by the child-restraint system manufacturer when installing the child-restraint system.

⚠ WARNING - Children on laps
Never hold a child on your lap or in your arms in a moving vehicle. Even a very strong person cannot hold onto a child in the event of even a minor collision.

⚠ WARNING - Hot metal parts
Safety belts and seats can become hot in a vehicle that has been closed during warm/hot weather; they could burn a child. Check seat covers and buckles before you place a child anywhere near them.

⚠ WARNING - Infants and young children

- Infants and young children are at much greater risk of serious injury or death in an accident or sudden stop if they are unrestrained or restrained improperly. Follow all instructions in this section and the instructions that came with an approved child safety system. The child restraint must be correctly installed in the vehicle, and the child must be correctly placed in the child restraint.
- All children under 12 are safest in the back seat.
- Never install a rear facing infant seat in the front passenger position. The baby will be injured or killed by the air bag if it deploys.
- Never allow a child to stand or kneel on the seat of a moving vehicle.

Larger children

As children grow, they may need to use new child-restraint systems, including larger child seats or booster seats, which are appropriate for their increased size.

A child who has outgrown available child-restraint systems should use the belts provided in the vehicle. When seated in the rear outboard seats, the child should be restrained by the lap/shoulder belt.

If the shoulder belt portion slightly touches the child's neck or face, try placing the child closer to the center of the vehicle. If the shoulder belt still touches their face or neck they need to be returned to a child restraint system. In addition, aftermarket devices are available from independent manufacturers which help pull the shoulder belt down and away from the child's face or neck.

⚠ WARNING - Shoulder belts on small children

- Never allow a shoulder belt to be in contact with a child's neck or face while the vehicle is in motion.
- If safety belts are not properly worn and adjusted on children, there is a risk of death or serious injury.



Pre-tensioner safety belt

Your vehicle is equipped with driver's and front passenger's pre-tensioner safety belts. The purpose of the pre-tensioner is to make sure that excess slack is taken up in certain frontal collisions. The pre-tensioners may activate along with the front air bags in frontal collisions based on angle of impact, seat belt usage and impact severity.

*** NOTICE**

The pre-tensioner seat belt is installed at the front seats, and the sensor is equipped inside the buckle, where presence of passenger is sensed by the fastening of the seat belts. Therefore, pre-tensioner will not activate if the passenger is not fastened with the seat belts. Likewise, it will activate if buckled even without a passenger in the seat. Pre-tensioner seat belt is designed to activate when the seatbelt is in use. To ensure the pretensioner seatbelts activate in event of a possible seatbelt buckle switch malfunction, the system is designed to activate regardless of whether a seat belt is in use or if no seat belt use is detected within 6 seconds of turning the ignition switch ON.

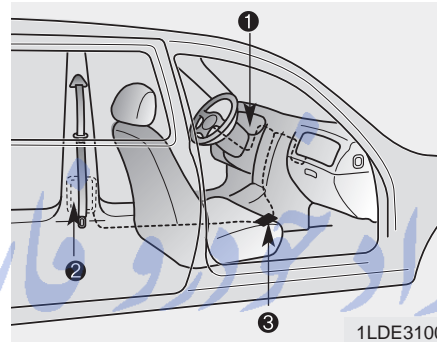

The seat belt pre-tensioner system consists mainly of the following components. Their locations are shown in the illustration.

- (1) SRS air bag warning light
- (2) Seatbelt pre-tensioner assembly
- (3) SRS air bag control module

⚠ WARNING - Safety belt adjustment

To obtain maximum benefit from a pre-tensioner seat belt:

- The safety belt must be worn correctly.
- The safety belt must be adjusted to the correct position.

Features of your vehicle

Load limiter (if equipped)

When the pre-tensioner activates, if the system senses excessive seat belt tension on the driver or passenger's seat belt, the load limiter inside the pre-tensioner will release some of the pressure on the affected seat belt.

⚠ WARNING - Air bag/Pre-tensioner dust

When the air bags and pre-tensioners are activated, a loud noise may be heard and fine dust, which may appear to be smoke, may be visible in the passenger compartment. This dust is not toxic. The dust may cause skin irritation and should not be breathed for prolonged periods. Ventilate the vehicle after impact and wash your hands and face thoroughly after an accident.

⚠ WARNING - Air bag/pre-tensioner warning light

If the SRS air bag warning light does not illuminate when the ignition key is turned to "ON", or if it remains illuminated after approximately 6 seconds, or if it illuminates while the vehicle is being driven, please have an authorized Kia dealer inspect the pre-tensioner and air bag system as soon as possible.

⚠ WARNING - Hot parts

The pre-tensioner assembly mechanism may become hot during activation. Do not touch the pre-tensioner seat belt assembly for several minutes after they have been activated.

⚠ WARNING - Replacing used pre-tensioners

- Pre-tensioners are designed to operate once. After activation, pre-tensioner seat belts must be replaced. All seat belts, of any type, should always be replaced after they have been worn during a collision.
- Do not attempt to replace the pre-tensioners yourself. This must be done by an authorized Kia dealer.

⚠ WARNING - Damaging the pre-tensioners

- Do not hit or strike the pre-tensioner assemblies, especially with a tool or heavy object.
- Do not attempt to service or repair the pre-tensioners.

CHILD RESTRAINT SYSTEM

We strongly recommend the use of a child seat or infant seat for small children and babies, and it is required by law in almost all states. This child seat or infant seat should be of appropriate size for the child and should be installed in accordance with the manufacturer's instructions.

Children riding in the car should sit on the rear seat and must always be properly restrained to minimize the risk of injury in an accident, sudden stop or sudden maneuver. According to accident statistics, children are safer when properly restrained in the rear seats than in the front seat.

Children could be injured or killed in a crash if their restraints are not properly secured. For small children and babies, a child seat or infant seat must be used. Before buying a particular child restraint system, make sure it fits your car and seat belts, and fits your child. Follow all the instructions provided by the child seat manufacturer when installing the child restraint system.



⚠ WARNING - Child restraints

- A child restraint system must be placed in the rear seat. Never install a child or infant seat on the front passenger's seat. Should an accident occur and cause the passenger air bag to deploy, it could severely injure or kill an infant or child seated in the front seat.
- Since a safety belt or child restraint system can become very hot if it is in a closed vehicle, be sure to check the seat cover and buckles before placing a child there.

(Continued)

(Continued)

- When the child restraint system is not in use, store it in the luggage area or fasten it with a safety belt so that it will not be thrown forward in the case of a sudden stop or an accident.
- Children who are too large to be in a child restraint should sit in the rear seat and be restrained with the available lap/shoulder belts.
- When using the vehicles lap/shoulder safety belts, always make sure that the shoulder belt portion is positioned midway over the shoulder, never across the neck or behind the back. The lap belt portion of the lap/shoulder belt must always be positioned as low as possible on the child's hips and as snug as possible.
- If the vehicle's safety belt will not properly fit the child, you must use an appropriate child restraint or booster seat in the rear.

(Continued)

(Continued)

- Never allow a child to stand up or kneel while the vehicle is moving.
- Never use an infant carrier or child seat that "hooks" over a seatback. It will not provide adequate protection in an accident.
- Never allow a child to be held while they are in a moving vehicle, as this could result in serious injury to the child in the event of an accident or a sudden stop. Holding a child in a moving vehicle does not provide the child with any protection during an accident, even if the person holding the child is wearing a seat belt.

Installing a child restraint system

For safety reasons, we recommend that the child restraint system be used in the rear seats.

⚠ WARNING

Never place a rear-facing child restraint in the front passenger seat, because of the danger that an inflating passenger side air bag could impact the rear-facing child restraint and kill the child.

Since all passenger safety belts move freely under normal conditions and only lock under extreme or emergency conditions (emergency lock mode), you must manually change these safety belts to the auto lock mode to secure a child restraint.

⚠ WARNING - Child seat installation

- Before installing the child restraint system, read the instructions supplied by the child restraint system manufacturer.
- If the safety belt does not operate as described in this section, have the system checked immediately by your authorized Kia dealer.
- Failure to observe this manual's instructions regarding child restraint system and the instructions provided with the child restraint system could increase the chance and/or severity of injury in an accident.

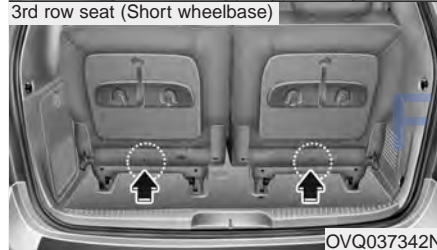
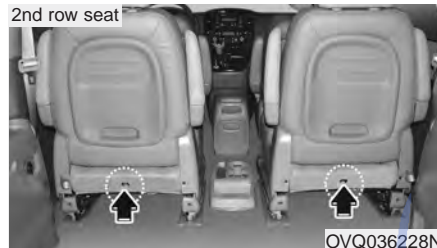

Securing a child restraint seat

Tether anchor system

Child restraint hook holders are located on the back of the rear seat cushions.



1. Route the child restraint seat strap over the seatback.
For vehicles with adjustable headrest, route the tether strap under the headrest and between the headrest posts, otherwise route the tether strap over the top of the seatback.
2. Connect the tether strap hook to the appropriate child restraint hook holder and tighten to secure the seat.

⚠ WARNING - Tether strap

If the tether strap is secured incorrectly, the child restraint seat may not be restrained properly in the event of a collision. Do not mount more than one child restraint seat to a tether anchorage, since the anchorage can then fail in a collision.

⚠ WARNING - Child restraint check

Check that the child restraint system is secure by pushing and pulling it in different directions. Incorrectly fitted child restraints may swing, twist, tip or come away causing death or injury.

⚠ WARNING
- **Child restraint anchorage**

- Child restraint anchorages are designed to withstand only those loads imposed by correctly fitted child restraints. Under no circumstances are they to be used for adult seat belts or harnesses or for attaching other items or equipment to the vehicle.
- The tether strap may not work properly if attached somewhere other than the correct tether anchor.

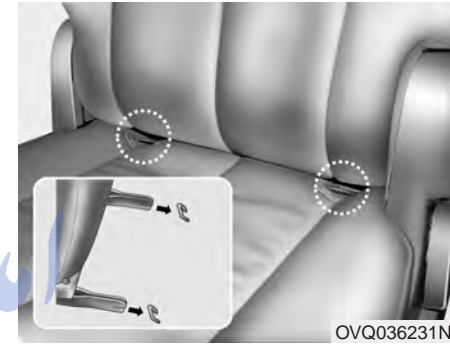
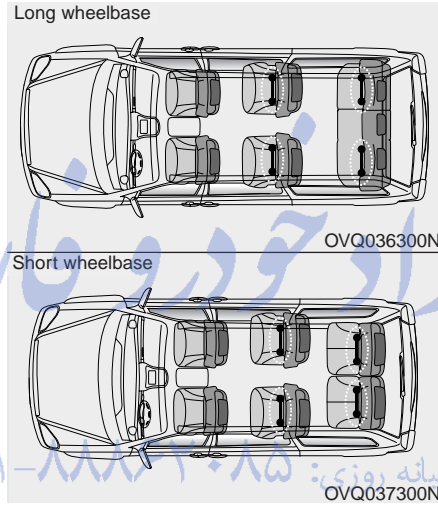

Child seat lower anchors

Some child seat manufacturers make child restraint seats that are labeled as International Standards Organization Fixed (ISOFIX) or ISOFIX-compatible child restraint seats. These seats include two rigid or webbing mounted attachments that connect to two ISOFIX anchors at specific seating positions in your vehicle. This type of child restraint seat eliminates the need to use seat belts to attach the child seat in the rear seats.

ISOFIX anchors have been provided in your vehicle. The ISOFIX anchors are located in the left and right outboard rear seating positions. Their locations are shown in the illustration. There is no ISOFIX anchor provided for the center rear seating position.

The ISOFIX anchors are located between the seatback and the seat cushion of the rear seat left and right outboard seating positions.

Follow the child seat manufacturer's instructions to properly install child restraint seats with ISOFIX or ISOFIX-compatible attachments.

Once you have installed the ISOFIX child restraint, assure that the seat is properly attached to the ISOFIX and tether anchors. Also, test the child restraint seat before you place the child in it. Tilt the seat from side to side. Also try to tug the seat forward. Check to see if the anchors hold the seat in place.

⚠ WARNING

When using the vehicle's "ISOFIX" system to install a child restraint system in the rear seat, all unused vehicle rear seat belt metal latch plates or tabs must be latched securely in their seat belt buckles and the seat belt webbing must be retracted behind the child restraint to prevent the child from reaching and taking hold of unretracted seat belts. Unlatched metal latch plates or tabs may allow the child to reach the unretracted seat belts which may result in strangulation and a serious injury or death to the child in the child restraint.

⚠ WARNING - ISOFIX Anchors

If the child restraint is not anchored properly, there is a significant risk of a child being seriously injured or killed in a collision.

⚠ WARNING - ISOFIX lower anchors

ISOFIX lower anchors are only to be used with the left and right rear outboard seating positions. Never attempt to attach an ISOFIX equipped seat in the center seating position. You may damage the anchors or the anchors may fail and break in a collision.

⚠ WARNING

Install the child restraint seat fully rearward against the seatback with the seatback in a vertical position, not reclined.

Placing a passenger safety belt into the auto lock mode

The use of the auto lock mode will ensure that the normal movement of the child in the vehicle does not cause the safety belt to be pulled out and loosen the firmness of its hold on the child restraint system. To secure a child restraint system, use the following procedure.

Features of your vehicle

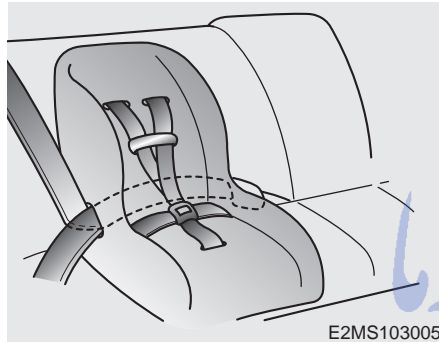

Installing a child restraint system by lap/shoulder belt

To install a child restraint system on the outboard or center rear seats, do the following:

1. Place the child restraint system in the seat and route the lap/shoulder belt around or through the restraint, following the restraint manufacturer's instructions. Be sure the safety belt webbing is not twisted.

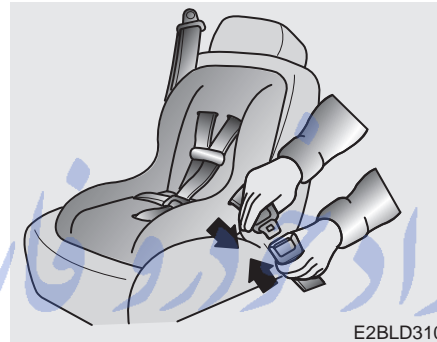

2. Fasten the lap/shoulder belt latch into the buckle. Listen for the distinct "click" sound.

Position the release button so that it is easy to access in case of an emergency.



3. Pull the shoulder portion of the safety belt all the way out. When the shoulder portion of the safety belt is fully extended, it will shift the retractor to the "Auto Lock" (child restraint) mode.

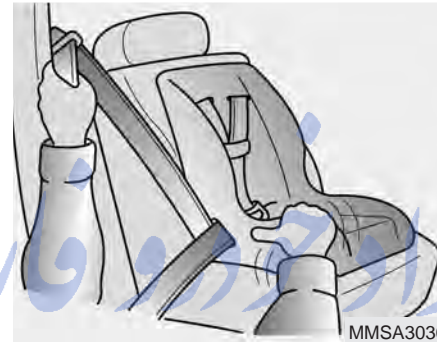

4. Slowly allow the shoulder portion of the safety belt to retract and listen for an audible “clicking” or “ratcheting” sound. This indicates that the retractor is in the “Auto Lock” mode. If no distinct sound is heard, repeat steps 3 and 4.

5. Remove as much slack from the belt as possible by pushing down on the child restraint system while feeding the shoulder belt back into the retractor.

6. Push and pull on the child restraint system to confirm that the safety belt is holding it firmly in place. If it is not, release the safety belt and repeat steps 2 through 6.

7. Double check that the retractor is in the “Auto Lock” mode by attempting to pull more of the safety belt out of the retractor. If you cannot, the retractor is in the “Auto Lock” mode.

To remove the child restraint, press the release button on the buckle and then pull the lap/shoulder belt out of the restraint and allow the safety belt to retract fully.

⚠ WARNING - Auto lock mode

The lap/shoulder belt automatically returns to the “emergency lock mode” whenever the belt is allowed to retract fully. Therefore, the preceding seven steps must be followed each time a child restraint is installed.

If the safety belt is not placed in the “Auto lock” mode, severe injury or death could occur to the child and/or other occupants in the vehicle in a collision, since the child restraint will not be effectively held in place.

When the safety belt is allowed to retract to its fully stowed position, the retractor will automatically switch from the “Auto Lock” mode to the emergency lock mode for normal adult usage.

AIR BAG - ADVANCED SUPPLEMENTAL RESTRAINT SYSTEM



- (1) Driver's air bag
- (2) Front passenger's air bag
- (3) Side air bag*
- (4) Curtain Air bag*
- (5) Side impact sensor*
- (6) Front impact sensor
- (7) Occupant classification system
- (8) Front seat position sensor
- (9) SRS Control Module

- Air bag inflation conditions
- Air bag non-inflation conditions
- Air bag warning light
- SRS care
- Air bag warning label

*: if equipped

What your air bag system does

Driver's air bag and front passenger's air bag are designed to supplement the protection offered by the safety belt in certain frontal collisions. Likewise, side air bag and curtain air bags are designed to supplement the protection offered by the safety belt in side collisions. Safety belts are designed to reduce the injury of the driver or passengers in case of impact or collision. No safety belt or air bag system can completely eliminate injuries that may cause in collisions or impacts. To help reduce impact on driver or passengers in any collision, safety belts must be correctly worn.

What your air bag system does not do

The air bag system is designed to supplement the protection offered by the safety belt system. **IT IS NOT A SUBSTITUTE FOR THE SAFETY BELT.**

The importance of using safety belts

There are four very important reasons to use safety belts even with an air bag supplemental restraint system. They:

- help keep you in the proper position (away from the air bag) when it inflates.
- reduce the risk of harm in rollover, side impact (vehicles not equipped with side and curtain air bags) or rear impact collisions, because an air bag is not designed to inflate in such situations and even a side curtain air bag is designed to inflate only in certain side impact collisions.
- reduce the risk of harm in frontal or side collisions which are not severe enough to actuate the air bag supplemental restraint system.
- reduce the risk of being ejected from your vehicle.

⚠ WARNING - Air bags & safety belts

- Even in vehicles with air bags, you and your passengers must always wear the safety belts provided in order to minimize the risk and severity of injury in the event of a collision or rollover.
- Always wear your safety belt. It can help keep you away from the air bags during heavy braking just before a collision.
- If occupants are not wearing safety belts or correctly seated, they cannot be protected, and thus face serious injury or death.
- Driver's and front passenger's air bag are designed to inflate only in certain frontal collision, and side and curtain air bags are designed to inflate in certain side impacts. Frontal air bags will generally not provide protection in side impacts (vehicles not equipped with side and curtain air bags) or rear impacts, rollovers, less severe frontal collisions. They will not provide protection from later impacts in a multi-impact collision.

(Continued)

(Continued)

- If your vehicle has been subjected to flood conditions (e.g. soaked carpeting/standing water on the floor of the vehicle, etc.) or if your vehicle has become flood damaged in any way, do not attempt to start the vehicle or put the key in the ignition before disconnecting the battery.

Disregarding this precaution may cause air bag deployment, which could result in serious personal injury or death. If your vehicle is subjected to flooded conditions, before starting the vehicle, have the vehicle towed to an authorized Kia dealer for inspection and necessary repairs.



Occupant classification system

The occupant classification system detects the presence of a passenger in the front passenger's seat and will turn off the front passenger's air bag under certain conditions.

The occupant classification system is designed to detect the presence of a properly-seated occupant and determine if the front passenger's air bag should be enabled (may inflate) or not.

Only the front passenger front air bag and front passenger side air bag are controlled by the Occupant Classification System.

Main components of occupant classification system

- Detection devices located under the front passenger seat frame.
- Electronic system to determine whether passenger air bag systems (both front and side) should be activated or deactivated.
- A indicator light located on the instrument panel which illuminates the words "PASSENGER AIR BAG OFF" when the passenger air bag system is deactivated.
- The instrument panel air bag indicator light is interconnected with the occupant classification system.



If there is no passenger in the front passenger seat or if the passenger in the front passenger seat is very light, (such as a child), the front **PASSENGER AIR BAG OFF** indicator may illuminate.

When this indicator is ON, the front passenger's air bag will not operate.

If there is no passenger in the front passenger's seat, the PASSENGER AIR BAG OFF indicator comes on, and the system shuts off not only the front passenger's front air bag but also the front passenger's side air bag.

Always be sure that you and all vehicle occupants are seated and restrained properly (sitting upright with the seat in an upright position, centered on the seat cushion, with the person's legs comfortably extended, feet on the floor, and wearing the safety belt properly) for the most effective protection by the air bag and the safety belt.

- The OCS may not function properly if the passenger takes actions which can defeat the detection system. These include:

- (1) Failing to sit in an upright position.
- (2) Leaning against the door or center console.
- (3) Sitting towards the sides or the front of the seat.
- (4) Putting legs on the dashboard or resting them on other locations which reduce the passenger weight on the front seat.
- (5) Improperly wearing the safety belt.
- (6) Reclining the seat back.

Features of your vehicle

- The "PASSENGER AIR BAG OFF" indicator illuminates after the ignition key is turned to the "ON" position or after the engine is started. If the front passenger seat is unoccupied or is occupied by very small person, or is occupied by someone who is improperly seated, the "PASSENGER AIR BAG OFF" indicator will remain illuminated. If the front passenger seat is occupied by someone of adult size and body shape, the "PASSENGER AIR BAG OFF" indicator will turn off after approximately 4 seconds.
- If the front passenger's seat is unoccupied, the "PASSENGER AIR BAG OFF" indicator will turn on, and the front passenger's air bag will not deploy in frontal crashes.
- If the "PASSENGER AIR BAG OFF" indicator illuminates, the front passenger's air bag will not deploy in frontal crashes.
- If the front passenger's seat is occupied by a person of adult size, the "PASSENGER AIR BAG OFF" indicator is not illuminated and the front passenger's air bag will deploy in frontal crashes.

Condition and operation in the front passenger occupant classification system

Condition detected by the occupant classification system	Indicator/Warning light		Devices
	"PASSENGER AIR BAG OFF" indicator light	SRS warning light	Front passenger air bag
1. Adult *1	Off	Off	Activated
2. Child*2 or child restraint system	On	Off	Deactivated
3. Unoccupied	On	Off	Deactivated

*1 The system detects a person who is generally adult size as an adult, thus allowing the passenger air bag to deploy. When a smaller adult sits in the front passenger seat, the system may detect their body shape as that of a child, thus preventing air bag deployment.

*2 When a larger child who has outgrown a child restraint system sits in the front passenger seat, the system may recognize him/her as an adult depending on his/her body shape or seating position, thus permitting air bag deployment.

CAUTION

If the "PASSENGER AIR BAG OFF" indicator illuminates or blinks continuously when a person of adult size sits in the front passenger's seat, it could be because that person isn't sitting properly in the seat. If this happens, turn the vehicle off, make sure the seat back is not reclined, have the passenger center on the seat cushion, with legs comfortably extended, and the safety belt properly positioned. Restart the vehicle and have the person remain in this position long enough to allow the system to detect the person and activate the passenger air bag.

CAUTION

If the occupant classification system is not working properly, the air bag warning light on the instrument panel will illuminate because the passenger's air bag is connected with the occupant classification system. If there is a malfunction of the occupant classification system, the "PASSENGER AIR BAG OFF" indicator will not illuminate and the front passenger's air bag will deploy in either a side or frontal crashes even if there is child or no occupant in the front passenger's seat.

Have an authorized Kia dealer inspect the occupant classification system with the SRS air bag system as soon as possible if any of following occur;

- *The SRS air bag warning light does not illuminate when the ignition key is turned to "ON" position.*
- *The SRS air bag warning light remains illuminated after illuminating or blinking for approximately 6 seconds.*
- *The SRS air bag warning light illuminates while the vehicle is being driven.*

WARNING

- Even though your vehicle is equipped with the occupant classification system, do not install a child restraint system in the front passenger seat. The child could be severely injured or killed if the air bag deploys. Children are afforded the most protection in the event of an accident when they are restrained by the proper restraint system in the rear seat.
- If the "PASSENGER AIR BAG OFF" indicator is illuminated when the front passenger's seat is occupied by a person of adult size who is seated properly, or if the "PASSENGER AIR BAG OFF" indicator is not illuminated when the front passenger's seat is unoccupied or occupied by a very small person, the occupant classification system is not working properly. Have your vehicle immediately inspected by your Kia dealer if the occupant classification system is not working properly.

(Continued)

(Continued)

- If a very low weight adult is seated in the front passenger seat, the occupant classification system may or may not turn off the right front passenger air bag, depending upon the person's seating position and body type. Everyone in your vehicle should wear a safety belt properly -- whether or not there is an air bag for that person.
- If the front seat passenger changes their seating position (for example, by not sitting upright, by sitting on the edge of the seat, or by otherwise being out of position), the "PASSENGER AIR BAG OFF" indicator may be turned on, and the passenger air bag may not deploy in a collision. Always be sure to sit properly in the front passenger seat and wear the safety belt properly and do not do any of the following.

(Continued)

Features of your vehicle

(Continued)



OVQ036013N

- Never put a heavy load in the front passenger seat or seatback pocket.

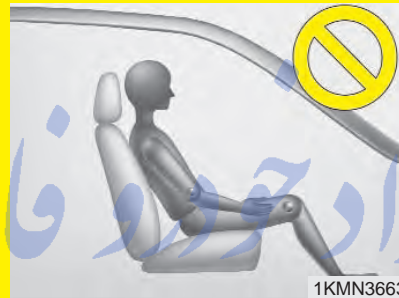

1KMN3663

- Never sit with hips shifted towards the front of the seat.



1KMN3665

- Never place feet on the dashboard.



OVQ036014N

- Never place feet on the front passenger seatback.



1KMN3662

- Never excessively recline the front passenger seatback.



1KMN3664

- Never lean on the center console.
- Never sit on one side of the front passenger seat.

(Continued)

(Continued)



- Always sit in a proper seating position.
- Kia does not endorse nor will it support any changes to any part or structure of the vehicle that could affect the advanced air bag system, including the occupant classification system. Specifically, the front passenger seat, dashboard or door should not be replaced except by an authorized Kia dealer using original Kia parts designed for this vehicle and model.

(Continued)

(Continued)

Any other such replacement or modification could adversely affect the operation of the occupant classification system and your advanced air bags. For the same reason, do not attach anything to the seat, dashboard or door, even temporarily. If the system is adversely affected, it could cause severe personal injuries or death in a collision.

- Do not put a heavy load in the front passenger seatback pocket or on the front passenger seat. Do not hang onto the front passenger seat. Do not hang any items such as seatback table on the front passenger seatback. Do not place feet on the front passenger seatback. Do not place any items under the front passenger seat. Any of these could interfere with proper sensor operation.

* NOTICE

- If luggage or other objects are placed on the front passenger's seat or if the temperature of the seat changes while the seat is unoccupied, the "PASSENGER AIR BAG OFF" indicator may blink. These conditions do not indicate a problem.
- Do not put heavy objects on the front passenger's seat. This may cause front passenger air bag deployment in the event of an accident, thus increasing your repair costs.

⚠ WARNING

- The front seat passenger air bag is much larger than the steering wheel air bag and inflates with considerably more force. It can seriously hurt or kill a passenger who is not in the proper position and wearing the safety belt properly. The front passengers should always move their seat as far back as practical and sit back in their seat.
- It is essential that the front passenger always wears their safety belts, even when the vehicle is moving in a parking lot or up a driveway into garage.

(Continued)

(Continued)

- If the driver brakes the vehicle heavily prior to an impact, unbelted occupants will be thrown forward. If the front passenger is not wearing the safety belts, they will be directly in front of the storage compartment when deployment occurs. In that situation, serious injury or death is possible.
- Never allow front passenger to put their hands, feet or face on or close to the instrument panel. In the event of air bag deployment, such a mispositioned occupant would be likely to suffer severe injury or death.
- Never allow children, pregnant women or weak persons to sit in the front passenger seat. Do not put child restraint system on the front passenger's seat either. They may be seriously injured by the air bag inflation when air bag deploys.

(Continued)

(Continued)

- Do not put objects or stickers on the instrument panel. Do not apply any accessory to the front windshield. Do not install aftermarket mirrors or accessories on the factory-installed rearview mirror. Any of these could interfere with the deployment of the air bag or could hit your body at high speed and cause severe bodily injury and even death.

Air bag system components

The main components of your SRS are:

- To indicate that your vehicle is equipped with air bags, the corresponding air bag covers are marked with "SRS AIR BAG".
 - Driver's air bag
 - Passenger's air bag
 - Side air bag
 - Curtain air bag
- A diagnostic system that continually monitors the system operation.
- An indicator light to warn you of a possible problem with the system.

- Emergency power backup in case your car's electrical system is disconnected in a crash.

The SRS uses a collection of sensors to gather information about the driver's seat position, the driver's and front passenger's safety belt usage and impact severity.

The driver's seat position sensor, which is installed on the seat track, determine if the seat is fore or aft of a reference position. Similarly, the safety belt usage sensors determine if the driver and front passenger's safety belts are fastened. These sensors provide the ability to control the SRS deployment based on how close the driver's seat is to the steering wheel, whether or not the safety belts are fastened, and the severity of the impact.

The advanced SRS offers the ability to control the air bag inflation with two levels. A first stage level is provided for moderate-severity impacts. A second stage level is provided for more severe impacts. According to the impact severity, seating position and safety belt usage, the SRSCM (SRS Control Module) controls the air bag inflation. **Failure to properly wear safety belts can increase the risk or severity of injury in an accident.**

Additionally, your SRS is equipped with an occupant classification system in the front passenger's seat. The occupant classification system detects the presence of a passenger in the front passenger's seat and will turn off the front passenger's air bag under certain conditions. For more detail, see "Occupant Classification System" in this section.

CAUTION

If the seat position sensor is not working properly, the SRS air bag warning light on the instrument panel will illuminate even if there is no malfunction of the SRS air bag system, because the SRS air bag warning light is connected with the seat position sensor. If the SRS air bag warning light does not illuminate when the ignition key is turned to the "ON" position, if it remains illuminated after illuminating or blinking for approximately 6 seconds, or if it illuminates while the vehicle is being driven, have an authorized Kia dealer inspect the seat position sensor and the advanced SRS air bag system as soon as possible.

WARNING

- Modification to the seat structure can adversely affect the seat position sensor and cause the air bag to deploy at a different level than should be provided.
- Failure to properly wear safety belts can increase the risk or severity of injury by causing the air bags to deploy at a different level than should be provided.
- Do not place any objects underneath the front seats which could damage the seat position sensor or interfere with the occupant classification system.
- Do not place any objects that may cause magnetic fields near the front seat. These may cause a malfunction of the seat position sensor.

(Continued)

(Continued)

- Ignoring the SRS indicator light (air bag indicator and passenger air bag off indicator) can result in serious or fatal injury if the air bags occupant classification system or pre-tensioners do not work properly. Have your car checked by a dealer as soon as possible if the SRS warning light alerts you to a potential problem.
- Sitting improperly or out of position can result in serious or fatal injury in a crash. All occupants should sit upright in their seats with their feet on the floor until the vehicle is parked and the ignition key is removed.

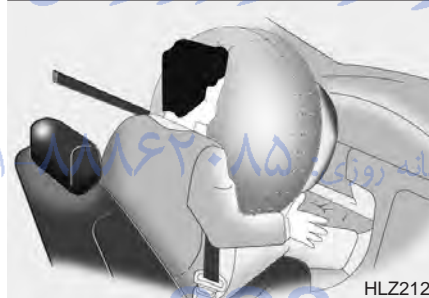

Driver's air bag

The driver's air bag is stored in the center of the steering wheel.

⚠ WARNING

- You must always sit as far back from the steering wheel air bag as possible (chest at least 250 mm (10 inches) away from the steering wheel), while still maintaining a comfortable seating position for good vehicle control, in order to reduce the risk of injury or death in a collision.
- Never place objects over the air bag storage compartments or between the air bags and yourself. Due to the speed and force of the air bag inflation, such objects could hit your body at high speed and cause severe bodily injury and even death.
- Do not put stickers or ornaments on the steering wheel cover. These may interfere with the deployment of the air bag.



1VQA2077

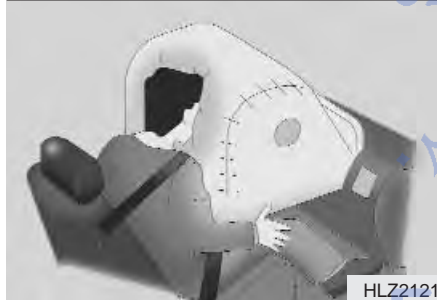

HLZ2121

Front passenger's air bag

Front passenger's air bag is stored in the instrument panel on the glove box. Since you cannot know which air bags will deploy or from what direction, never put any objects or ornaments on the instrument panel.

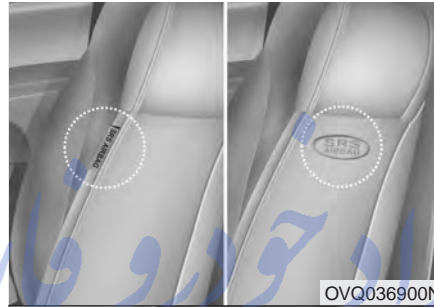

OVQ036900N

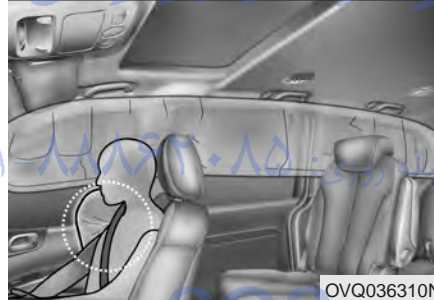

OVQ036310N

Side air bag (if equipped)

Side air bags are stored in the left side of the driver's seat, right side of the front passenger's seat.

If air bag inflation conditions are met (side collision), they will inflate.

⚠ WARNING

- Do not use any accessory seat covers for the vehicle equipped with side air bags. Use of seat covers could interfere with side air bag deployment. If seat or seat cover is damaged, have the vehicle checked and repaired by an authorized Kia dealer. Inform them that your vehicle is equipped with side air bags and an occupant detection system.
- Do not make modifications or additions to the seats. If inappropriate seats are used, unexpected injury may result in due to the malfunction of the air bag system.

Features of your vehicle

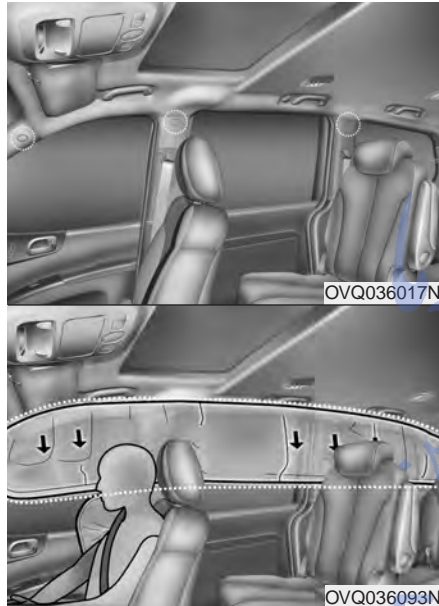

Curtain air bag (if equipped)

Curtain air bags are located along both sides of the roof rails above the front and rear doors.

It is designed to help protect the heads of the front seat occupants and the rear outboard seat occupants in certain side impact collisions.

- If the curtain air bag deploys, it remains inflated for approximately 3 seconds. The curtain air bag deployment occurs only on the side of the vehicle affected by the impact.
- The side air bags (side and curtain air bags) are not designed to deploy during collisions from the front or rear of the vehicle or in most rollover situations.
- The curtain air bags are designed to deploy only during certain side-impact collisions, depending on the crash severity, angle, speed and impact. The curtain air bags are not designed to deploy in all side impact situations.

⚠ WARNING

- In order for side air bags (side and curtain air bags) to provide its best protection, both front seat occupants and both outboard rear occupants should sit in an upright position with the seat belts properly fastened. Importantly, children should sit in a proper child restraint system in the rear seat.

(Continued)

(Continued)

- When children are seated in the rear outboard seats, they must be seated in the proper child restraint system. Make sure to put the child restraint system as far away from the door side as possible, and secure the child restraint system in a locked position.
 - Do not allow the passengers to lean their heads or bodies onto doors, put their arms on the doors, stretch their arms out of the window, or place objects between the doors and passengers when they are seated on seats equipped with side air bags.
 - Never try to open or repair any components of the side curtain air bag system. This should only be done by an authorized Kia dealer.
- Failure to follow the above mentioned instructions can result in injury or death to the vehicle occupants in an accident.

Why didn't my air bag go off in a collision?

(Inflation and non-inflation conditions of the air bag)

There are many types of accidents in which the air bag would not be expected to provide additional protection. These include rear impacts, second or third collisions in multiple impact accidents, as well as low speed impacts. In other words, just because your vehicle is damaged and even if it is totally unusable, don't be surprised that the air bags did not inflate.



OVQ036400N/1VQA2081/1VQA2080/1VQA2079/1VQA2323

Air bag collision sensors

- (1) SRS control module
- (2) Front impact sensor

- (3) Side impact sensor (if equipped)
- (4) Side impact sensor (if equipped)

⚠ WARNING

- Do not hit or allow any objects to impact the locations where air bag or sensors are installed. This may cause unexpected air bag deployment, which could result in serious personal injury or death.
- If the installation location or angle of the sensors is altered in any way, the air bags may deploy when they should not or they may not deploy when they should, causing severe injury or death. Therefore, do not try to perform maintenance on or around the air bag sensors. Have the vehicle checked and repaired by an authorized Kia dealer.

(Continued)

(Continued)

- Problems may arise if the sensor installation angles are changed due to the deformation of front bumper, body or B/C pillar where side collision sensors are installed. Have the vehicle checked and repaired by an authorized Kia dealer.
- Your vehicle has been designed to absorb impact and deploy the air bag(s) in certain collisions. Installing aftermarket bumper guards or replacing a bumper with non-genuine parts may adversely affect your vehicles collision and air bag deployment performance.

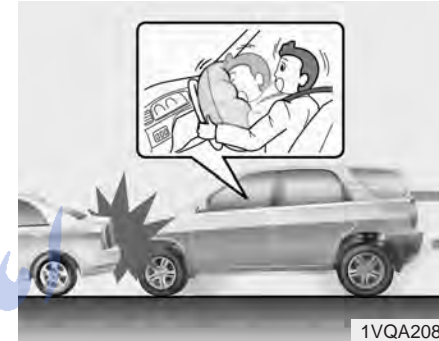

Air bag inflation conditions

Front air bag

Front air bags are designed to inflate when the impact is delivered to front collision sensors depending on the intensity, speed or angles of impact of the front collision - generally from an area a little to the left to a little to the right of straight ahead.



OVQ036018N



OVQ036016N

Side air bags (if equipped)

Side air bags (side and/or curtain air bags) are designed to inflate when an impact is detected by side collision sensors depending on the strength, speed or angles of impact of side impact of side impact collision or rollover.

Although the front air bags (driver's and front passenger's air bags) are designed to inflate only in frontal collision, it may inflate in any collision if front impact sensors detect a sufficient impact. Side air bags (side and/or curtain air bags) are designed to inflate only in side impact collision, it may inflate in any collision if side impact sensors detect a sufficient impact.

If the vehicle chassis is impacted by bumps or objects on unimproved roads or sidewalks, air bags may deploy. Drive carefully on unimproved roads or on surfaces not designed for vehicle traffic to prevent unintended air bag deployment.

To protect occupants, front air bags or pre-tensioner seat belts may deploy in certain side impact collisions.



1VQA2086

Air bag non-inflation conditions

- In certain low-speed collisions the air bags may not deploy. The air bags are designed not to deploy in such cases because the risk of injuries which can be caused by the air bags exceeds the benefits they provide in protecting occupants.

PharmaSOS.com

Features of your vehicle



- Frontal air bags are not designed to inflate in rear collisions, because occupants are moved backward by the force of the impact. In this case, the air bags do not provide proper protection.



- Front air bags may not inflate in side impact collision, because occupants move to the direction of the collision, and thus in side impacts, frontal air bag deployment does not provide occupant protection.

However, side or curtain air bags may inflate depending on the intensity, vehicle speed and angles of impact.

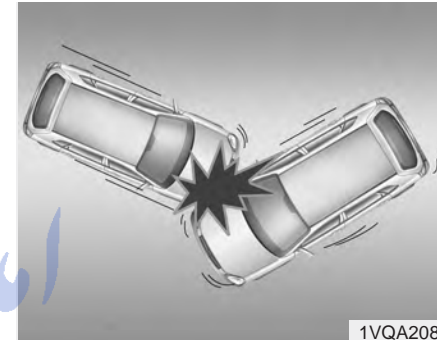

- In a slant or angled collision, the force of impact may direct the occupants in a direction between the front and side air bags, and thus the sensors may not deploy any air bags.

FarmaSOS.com

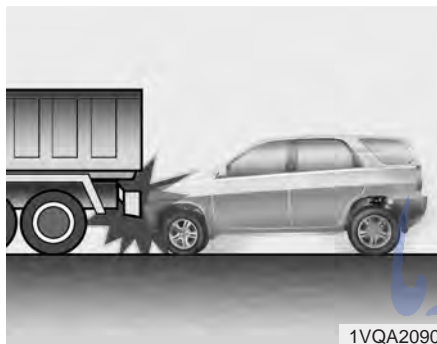

1VQA2090

- Just before impact, drivers often brake heavily. Such heavy braking lowers the front portion of the vehicle causing it to “ride” under a vehicle with a higher ground clearance. Air bags may not inflate in this “under-ride” situation because deceleration forces that are detected by sensors may be significantly altered by such “under-ride” collisions.



1VQA2091

- Air bags may not inflate in rollover accidents because air bag deployment would not provide proper protection to the occupants. However, side air bags may inflate when the vehicle is rolled over by a side impact collision, if the vehicle is equipped with side air bags and curtain air bags.

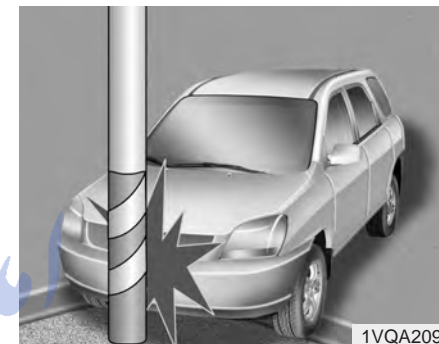

1VQA2092

- Air bags may not inflate if the vehicle collides with objects such as utility poles or trees, where the point of impact is concentrated to one area and the full force of the impact is not delivered to the sensors.

FarmaSOS.com

Features of your vehicle

Air bag system operation

- Air bag only operates when the ignition switch is turned to the ON or START positions.
- Air bags inflate instantly in the event of serious frontal or side collision (if equipped with side air bag or curtain air bag) in order to help protect the occupants from serious physical injury.
- There is no single speed at which the air bags will inflate.

Generally, air bags are designed to inflate by the severity of a collision and its direction. These two factors determine whether the sensors send out an electronic deployment/inflation signal.

- Air bag deployment depends on a number of factors including vehicle speed, angles of impact and the density and stiffness of the vehicles or objects which your vehicle hits in the collision. However, factors are not limited to those mentioned above.
- The front air bags will completely inflate and deflate in an instant. It is virtually impossible for you to see the air bags inflate during an accident. It is much more likely that you will simply see the deflated air bags hanging out of their storage compartments after the collision.

- In order to help provide protection in a severe collision, the air bags must inflate rapidly. The speed of air bag inflation is a consequence of the extremely short time in which a collision occurs and the need to get the air bag between the occupant and the vehicle structures before the occupant impacts those structures. This speed of inflation reduces the risk of serious or life-threatening injuries in a severe collision and is thus a necessary part of air bag design.

However, air bag inflation can also cause injuries which normally can include facial abrasions, bruises and broken bones, and sometimes more serious injuries because that inflation speed also causes the air bags to expand with a great deal of force.

- **There are even circumstances under which contact with the steering wheel air bag can cause fatal injuries, especially if the occupant is positioned excessively close to the steering wheel.**

⚠ WARNING - Seated positioning

- Driver should sit as far back (at least 250 mm (10 inches) away) from the steering wheel air bag as possible to reduce the risk of injury or death in a collision. The front passenger should always move their seat as far back as possible and sit back in their seat.
- Air bag inflates instantly in an event of collision, passengers may be injured by the air bag expansion force if they are not in proper position.
- Air bag inflation may cause injuries which normally include facial or bodily abrasions, injuries by the broken glasses or burns by the explosives.

Noise and smoke

When the air bags inflate, they make a loud noise and they leave smoke and powder in the air inside of the vehicle. This is normal and is a result of the ignition of the air bag inflator. After the air bag inflates, you may feel substantial discomfort in breathing due to the contact of your chest to both the safety belt and the air bag, as well as from breathing the smoke and powder. **We strongly urge you to open your doors and/or windows as soon as possible after impact in order to reduce discomfort and prevent prolonged exposure to the smoke and powder.**

Though smoke and powder are non-toxic, it may cause irritation to the skin (eyes, nose and throat etc). If this is the case, wash and rinse with the cold water immediately and consult the doctor if the symptom persists.

⚠ WARNING

When the air bags deploy, the air bag related parts in steering wheel and/or instrument panel and/or in both sides of the roof rails above the front and rear doors are very hot. To prevent injury, do not touch the air bag storage areas internal components immediately after an air bag has inflated.



Installing a child restraint on a front passenger's seat is forbidden.

Never place a rear-facing child restraint in the front passenger's seat. If the air bag deploys, it would impact the rear-facing child restraint, causing serious or fatal injury.

In addition, do not place front-facing child restraint in the front passenger's seat either. If the front passenger air bag inflates, it would cause serious or fatal injuries to the child.

⚠ WARNING

- Never put child restraint in the front passenger's seat. If the front passenger air bag inflates, it would cause serious or fatal injuries.
- When children are seated in the rear outboard seats in which side air bags are equipped, be sure to put the child restraint system as far away from the door side as possible, and secure the child restraint system to be locked in position.

Inflation of side or curtain air bag could cause serious injury or death due to the expansion impact.



Air bag warning light

The purpose of the air bag warning light in your instrument panel is to alert you of a potential problem with your air bag - Supplemental Restraint System (SRS).

When the ignition switch is turned ON, the indicator light should blink or illuminate for approximately 6 seconds, then go off.

Have the system checked if:

- The light does not turn on briefly when you turn the ignition ON.
- The light stays on after the engine starts.
- The light comes on while the vehicle is in motion.

SRS care

Your Supplemental Restraint System is virtually maintenance-free. There are no parts which you can service.

You must have the system serviced under the following circumstances:

- If an air bag ever inflates, the air bag must be replaced. Do not try to remove or discard the air bag by yourself. This must be done by an authorized Kia dealer.
- If the air bag warning indicator light alerts you to a problem, have the air bag system checked as soon as possible. Otherwise, your air bag system may be ineffective.

⚠ WARNING - No modification

Do not modify any part of the air bag system. Modification could make the air bag system ineffective or could cause unnecessary deployment.

⚠ WARNING - No maintenance or repair

- Do not modify your steering wheel, seat or any other part of the Supplemental Restraint System. Modification could make the system inoperable.
- Do not work on the system's components or wiring. This could cause the air bags to inflate inadvertently, possibly seriously injuring someone. Working on the system could also disable the system so that the air bags would not deploy in a collision.
- Any work on the SRS system, such as removing, installing, repairing, or any work on the steering wheel must be performed by a qualified Kia technician. Improper handling of the air bag system may result in serious personal injury or death.

When repairing or scrapping the vehicles

- Repairing steering wheel, instrument panel, center console or roofs, or installing car audio around center console or painting front metal sheet could disable the air bag system. Have them checked by an authorized Kia dealer.
- When leaving the vehicle at an authorized Kia dealer, inform the facility that the vehicle is equipped with air bag system, and leave the owner's manual in the vehicle.
- Since air bag system contains explosive chemical substances, contact an authorized Kia dealer when scrapping the vehicle.

Features of your vehicle



Air bag warning label

Air bag warning labels which are now required by the Canadian Motor Vehicle Safety Standard (CMVSS) are attached to alert driver and passengers of potential risk of air bag system.

Note that these government warnings focus on the risk to children, Kia also wants you to be aware of the risks which adults are exposed to. Those have been described in previous pages.

STEERING WHEEL

Power steering

Power steering uses energy from the engine to assist you in steering the vehicle. If the engine is off or if the power steering system becomes inoperative, the vehicle may still be steered, but it will require increased steering effort.

Should you notice any change in the effort required to steer during normal vehicle operation, have the power steering checked by an Authorized Kia Dealer.

CAUTION

- *Never hold the steering wheel against a stop (extreme right or left turn) for more than 5 seconds with the engine running. Holding the steering wheel for more than 5 seconds in either position may cause damage to the power steering pump.*
- *If the power steering drive belt breaks or if the power steering pump malfunctions, the steering effort will greatly increase.*

*** NOTICE**

If the vehicle is parked for extended periods outside in cold weather (below -10 °C/14 °F), the power steering may require increased effort when the engine is first started. This is caused by increased fluid viscosity due to the cold weather and does not indicate a malfunction.

When this happens, increase the engine RPM by depressing accelerator until the RPM reaches 1,500 rpm then release or let the engine idle for two or three minutes to warm up the fluid.

تلفن شبانه روزی: ۰۲۱-۸۸۸۶۲۰۸۵

FarmaSOS.com

Features of your vehicle

Tilt steering

A tilt steering wheel allows you to adjust the steering wheel before you drive. You can also raise it to the highest level to give your legs more room when you exit and enter the vehicle.

The steering wheel should be positioned so that it is comfortable for you to drive, while permitting you to see the instrument panel warning lights and gauges.

⚠ WARNING

- **Never adjust the angle of steering wheel while driving. You may lose your steering control and cause severe personal injury or accidents.**
- **After adjusting, push the steering wheel both up and down to be certain it is locked in position.**

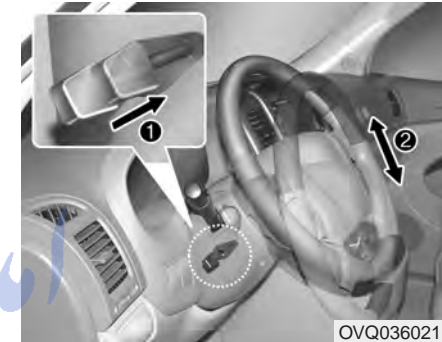

To change the steering wheel angle, pull up the lock release lever (1), adjust the steering wheel to the desired angle (2), then release the lock-release lever to lock the steering wheel in place. Be sure to adjust the steering wheel to the desired position before driving.

شبهانه روزی: ۰۲۱-۸۸۶۲۰۸۵

FarmaSOS.com

MIRRORS

Outside rearview mirror

Be sure to adjust mirror angles before driving.

Your vehicle is equipped with both left-hand and right-hand outside rearview mirrors. The mirrors can be adjusted remotely with the remote switch. The mirror heads can be folded back to prevent damage during an automatic car wash or when passing in a narrow street.

⚠ WARNING - Rearview mirrors

- The right outside rearview mirror is convex. Objects seen in the mirror are closer than they appear.
- Use your interior rearview mirror or direct observation to determine the actual distance of following vehicles when changing lanes.

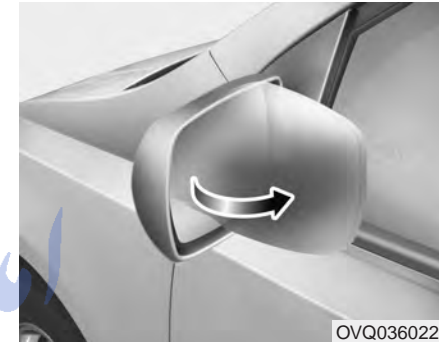

Folding the outside rearview mirror

To fold outside rearview mirror, grasp the housing of mirror and then fold it toward the rear of the vehicle.

⚠ CAUTION

Do not scrape ice off the mirror face; this may damage the surface of the glass. If ice should restrict movement of the mirror, do not force the mirror for adjustment. To remove ice, use a deicer spray, or a sponge or soft cloth with very warm water.

Features of your vehicle

Outside rearview mirror heater (if equipped)

The outside rearview mirror heater is actuated in connection with the rear window defroster. To heat the outside rearview mirror glass, push the button for the rear window defroster.

The rearview mirror heater (and rear window defroster) will not operate unless the engine is running.

The outside rearview mirror glass will be heated for defrosting or defogging and will give you improved rear vision in inclement weather conditions. Push the button again to turn the heater off. The outside rearview mirror heater automatically turns off after 20 minutes.



Electric remote control

The electric remote control mirror switch allows you to adjust the position of the left and right outside rearview mirrors. To adjust the position of either mirror, move the lever (1) to R or L to select the right side mirror or the left side mirror, then press a corresponding point (▲) on the mirror adjustment control to position the selected mirror up, down, left or right.

After adjustment, put the lever into neutral position to prevent the inadvertent adjustment.

CAUTION

- The mirrors stop moving when they reach the maximum adjusting angles, but the motor continues to operate while the switch is depressed. Do not depress the switch longer than necessary, the motor may be damaged.
- Do not attempt to adjust the outside rearview mirror by hand. Doing so may damage the parts.

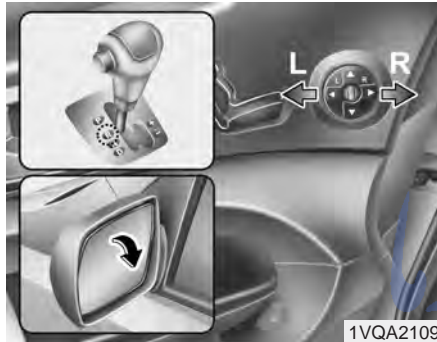

Automatic mirror adjustment in reverse maneuvers (if equipped)

When the transaxle gear is shifted into reverse (R), the outside rearview mirror(s) will automatically be turned downward about 5 degrees to improve driver visibility. It will stay in that position until the transaxle shift lever is shifted out of reverse (R).

L : Both the left and right outside rearview mirrors will be turned downward about 5 degrees.

R : Only the right outside rearview mirror will be turned downward about 5 degrees.

Center : Automatic mirror adjustment function is disabled. No mirror will be turned downward.

The outside rearview mirror(s) will return to its previous position automatically if outside rearview mirror selection switch is changed to another position, or transaxle shift lever is shifted out of reverse (R).

(Examples)

If the shift lever is shifted into reverse (R) when the outside rearview mirror selection switch is in L, both the right and left outside rearview mirrors will automatically be turned down about 5 degrees.

If the outside rearview mirror selection switch is set to R while shift lever is in reverse (R), the left outside rearview mirror will return to its previous position. The right outside rearview mirror will not return to its previous position.

If the shift lever is shifted into any other range OR the outside rearview mirror selection switch is set to center, the right outside rearview mirror will automatically return to its original position.

Day/night rearview mirror

Adjust the rearview mirror to center on the view through the rear window. Make this adjustment before you start driving.

⚠ WARNING - Rear visibility
Do not place objects in the rear seat or cargo area which would interfere with your vision out the rear window.

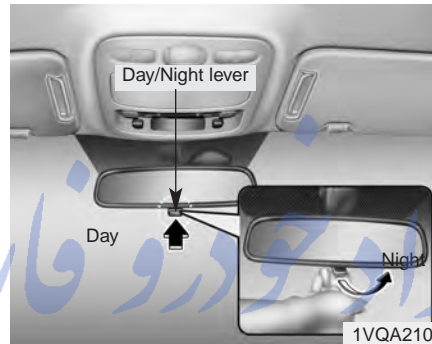

Manual type

Make this adjustment before you start driving and while the day/night lever is in the day position.

Pull the day/night lever toward you to reduce glare from the headlights of vehicles behind you during night driving.

Remember that you lose some rearview clarity in the night position.

Electric type

The electric rearview mirror automatically controls the glare from the headlights of the car behind you in nighttime or low light driving conditions. The sensor mounted in the mirror senses the light level around the vehicle, and through a chemical reaction, automatically controls the headlight glare from vehicles behind you.

When the engine is running, the glare is automatically controlled by the sensor mounted in the rearview mirror.

Whenever the shift lever is shifted into reverse (R), the mirror will automatically go to the brightest setting in order to improve the drivers view behind the vehicle.

⚠ CAUTION

When cleaning the mirror, use a paper towel or similar material dampened with glass cleaner. Do not spray glass cleaner directly on the mirror as that may cause the liquid cleaner to enter the mirror housing.

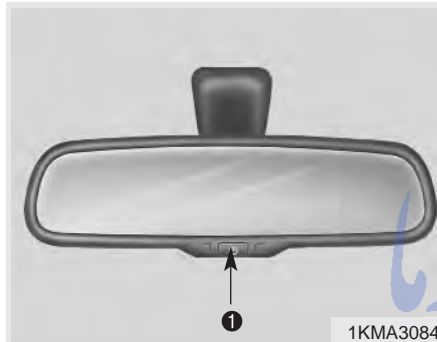

Type A

To operate the electric rearview mirror

Press the ON/OFF button (1) to turn the automatic-dimming function on. The mirror indicator light will illuminate.

Press the ON/OFF button to turn the automatic-dimming function off. The mirror indicator light will turn off.



Type B (with homelink wireless control system)

To operate the electric rearview mirror

Press the I button (1) to turn the automatic-dimming function on. The mirror indicator light will illuminate.

Press the O button (2) to turn the automatic-dimming function off. The mirror indicator light will turn off.

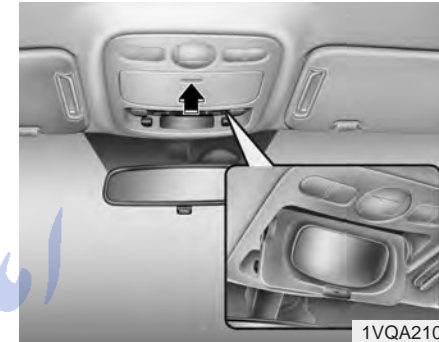

Conversation mirror

The mirror is a convenient feature to help the front passenger talk with rear passengers without turning the head or body rearward.

To use the mirror, push the cover and open it.

Adjust mirror angle to the desired position.

Close the cover after use.

⚠ WARNING

Do not adjust the mirror angle or talk with rear passengers for a long time while driving. You may lose your steering control and cause severe personal injury or accidents.

FarmaSOS.com

Features of your vehicle

INSTRUMENT CLUSTER

■ Type A



1. Tachometer
2. Turn signal indicators
3. Speedometer
4. Engine temperature gauge
5. Warning and indicator lights
6. Shift position indicator (Automatic transaxle only)
7. Odometer/Trip odometer
8. Fuel gauge

■ Type B



OVQ037026N/OVQ037027N

GAUGES



Speedometer

The speedometer indicates the forward speed of the vehicle.



Odometer/Trip odometer

You can choose the odometer, trip odometer A and trip odometer B by pressing the tripmeter mode button.



Odometer

The odometer indicates the total distance the vehicle has been driven.

FarmaSOS.com

Features of your vehicle



1VQA2125

Trip odometer

TRIP A: Trip odometer A

TRIP B: Trip odometer B

The trip odometer indicates the distance of individual trips selected by the driver. Trip odometer A and B can be reset to 0 by pressing the reset button for 1 second or more, and then releasing.



OVQ036406N

Tachometer

The tachometer indicates the approximate number of engine revolutions per minute (rpm).

Use the tachometer to select the correct shift points and to prevent lugging and/or over-revving the engine.

The tachometer pointer may move slightly when the ignition switch is in ACC or ON position with the engine OFF. This movement is normal and will not affect the accuracy of the tachometer once the engine is running.

CAUTION

Do not operate the engine within the tachometer's RED ZONE.

This may cause severe engine damage.



OVQ036031N

Engine temperature gauge

This gauge shows the temperature of the engine coolant when the ignition switch is ON.

Do not continue driving with an overheated engine. If your vehicle overheats, refer to "Overheating" in the Index.

CAUTION

If the gauge pointer moves beyond the normal range area toward the "H" position, it indicates overheating that may damage the engine.



Fuel gauge

The fuel gauge indicates the approximate amount of fuel remaining in the fuel tank.

Fuel tank capacity : 80 liters (21 US gallons)

The fuel gauge is supplemented by a low fuel warning light, which will illuminate when the fuel tank is nearly empty.

⚠ WARNING - Fuel gauge
Running out of fuel can expose vehicle occupants to danger. You must stop and obtain additional fuel as soon as possible after the warning light comes on or when the gauge indicator comes close to the E level.



Instrument panel illumination

When the vehicle's parking lights or headlights are on, rotate the illumination control knob to adjust the instrument panel illumination intensity.

The instrument cluster (Type B) illumination intensity can be adjusted by rotating the control knob with the headlight switch in any position when the ignition switch is in ON position.

FarmaSOS.com

TRIP COMPUTER (IF EQUIPPED)



The trip computer is a microcomputer-controlled driver information system that displays information related to driving, including compass, distance to empty, driving time, average fuel consumption and outside temperature on the display when the ignition switch is in ON position. All stored driving information is reset if the battery is disconnected.

Mode selection

The compass is always displayed until the display is turned off. Push the MODE button to select distance to empty, driving time, average fuel consumption and outside temperature functions.

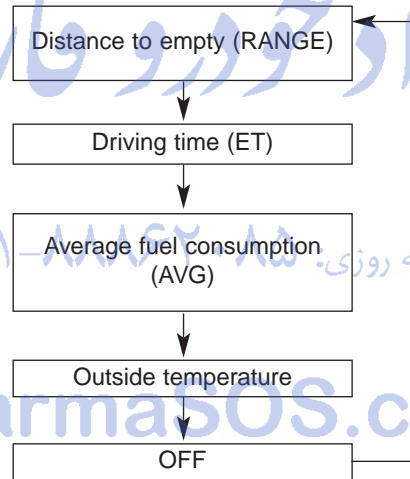

Compass

The vehicle compass displays the direction the vehicle is heading.

Heading display

- E : East
- W : West
- S : South
- N : North
- ex) NE : North East

* NOTICE

If new vehicle is first driven, perform calibration procedure as follows.

Calibration procedure

The compass may not indicate the correct compass direction when you are driving in certain areas (tunnel, parking garage, underground parking lot, near transformer substation, etc.), and the following may occur:

- The compass headings become inaccurate.
- The compass heading doesn't change when the vehicle changes direction.
- Some compass headings are not displayed.
- The compass headings are inaccurate in long distance driving.

If the vehicle's compass headings become inaccurate continuously, the compass should be manually calibrated as follows:



1. Move the vehicle away from any large steel structures or power generating cables or equipment.
2. Check the terrestrial deviation angle value by pressing and holding the MODE button for 4.5 seconds until the current terrestrial deviation angle value appears in the display.
3. If the terrestrial deviation angle value is different for your country, set the correct angle referring to "Setting the compass zone" and perform the "Calibration procedure" again.
4. Make sure the vehicle windshield wipers are turned off.

5. Press and hold the MODE button again for 2~4.5 seconds until the "turn" appears and "DIR" blinks in the display and release the button.
6. Drive your vehicle in at least 1 complete (either clockwise or counter-clockwise) circle at less than 5 km/h (3 mph) within 10 minutes until the compass heading appears.
7. If the vehicle's compass headings become inaccurate again, repeat steps 1 through 6 above.

* NOTICE

If you press the MODE button before the calibration is completed or the vehicle is not rotated within 10 minutes after "turn" appears and "DIR" blinks, the correction will be cancelled.

Features of your vehicle



Setting the compass zone

This compass must be set to compensate for the variation between true north and magnetic north. To set variation:

1. Find your current location and terrestrial deviation angle value on the zone map.
2. Press and hold the MODE button for 4.5 seconds. The current terrestrial deviation angle value will appear in the display.

3. Release the MODE button and press the RESET button repeatedly until the correct terrestrial deviation angle value for your location appears in the display.
4. Press and hold the MODE button for more than 1 second, and then the display will show a compass direction.

* NOTICE

If you press the MODE button for less than 1 second before new compass zone is set, the correction is cancelled.

Also, if the correction is not completed within 30 seconds, the current terrestrial deviation angle value will blink for 2 seconds and the correction is cancelled.

* NOTICE

1. Do not install a ski rack, antenna, etc. that is attached to the vehicle using a magnet as anything attached to the roof of the vehicle with a magnet will effect compass operation.
2. If the compass deviates from the correct indication after repeated adjustment, have the compass checked at an authorized dealer.
3. The compass may not indicate the correct compass point in tunnels or while driving up or down a steep hill. (The compass returns to the correct compass point when the vehicle moves to an area where the geomagnetism is stabilized.)



Distance to empty (“RANGE” shown on display)

This mode indicates the estimated distance to empty based on the current fuel in the fuel tank and the amount of fuel delivered to the engine. When the remaining distance is below 50 km (30 miles), a blinking “----” symbol will be displayed.

The meter's working range is from 50 to 1500 km (30 to 1500 miles).

*** NOTICE**

- If the vehicle is not on level ground or the battery power has been interrupted, the “Distance to empty” function may not operate correctly. The trip computer may not register additional fuel if less than 6 liters (1.6 gallons) of fuel are added to the vehicle.
- The fuel consumption and distance to empty values may vary significantly based on driving conditions, driving habits, and condition of the vehicle.
- The distance to empty value is an estimate of the available driving distance. This value may differ from the actual driving distance available.



Driving time (“ET” shown on display)

This mode indicates the total time traveled since the last driving time reset. Even if the vehicle is not in motion, the driving time keeps going while the engine is running.

The meter's working range is from 0:00~99:59.

Pressing the RESET button for less than 4 seconds, when the driving time is being displayed, clears the driving time to zero.



1VQA2320

Average fuel consumption (“AVG” shown on display)

This mode calculates the average fuel consumption from the total fuel used and the distance since the last average consumption reset. The total fuel used is calculated from the fuel consumption input. For an accurate calculation, drive more than 500 m (0.3 miles).

The meter's working range is from 0.0 to 99.9 l/100 km (0.0 to 99.9 miles per gallon).

Pressing the RESET button for less than 4 seconds, when the average fuel consumption is being displayed, clears the average fuel consumption to “-” until the vehicle is moved to 500 m (0.3 miles).



OVQ036040N

Outside temperature

This mode indicates the outside temperature around the vehicle.

The meter's working range is from -40°C to 60°C (-40°F~140°F).

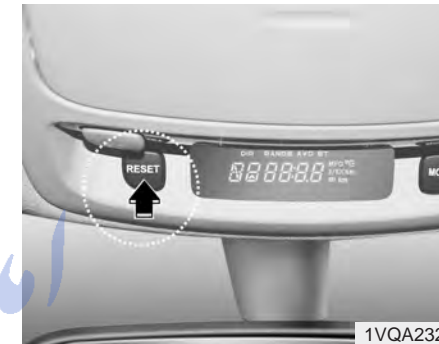

1VQA2322

Unit conversion

The unit on each mode can be changed by pushing the RESET button for more than 4 seconds as follows:

- Distance to empty: km ↔ MI
- Average fuel consumption: l/100km ↔ MPG
- Outside temperature: °C ↔ °F

The units on the mode of distance to empty and average fuel consumption are changed together. However, the outside temperature mode display units are changed separately.

WARNINGS AND INDICATORS

Checking operation

All warning lights are checked by turning the ignition switch ON (do not start the engine). Any light that does not illuminate should be checked by an Authorized Kia Dealer.

After starting the engine, check to make sure that all warning lights are off. If any are still on, this indicates a situation that needs attention. When releasing the parking brake, the brake system warning light should go off. The fuel warning light will stay on if the fuel level is low.

Air bag warning light



This warning light will illuminate for approximately 6 seconds each time you turn the ignition switch to the ON position.

If this indicator does not go out, or if it illuminates while the vehicle is being driven, see an authorized Kia Dealer for immediate service.

Anti-lock brake system (ABS) warning light



This light illuminates if the key is turned to ON and goes off in approximately 3 seconds if the system is operating normally.

If the light stays on, you may have a problem with your ABS system. Contact an authorized Kia dealer as soon as possible.

Electronic brake force distribution (EBD) system warning light



If two warning lights illuminate at the same time while driving, your vehicle has a problem with ABS and EBD system.

In this case, your ABS system and regular brake system may not work normally. Have the vehicle checked by an Authorized Kia Dealer as soon as possible.



⚠ WARNING

If the both ABS and Brake warning lights are ON and stay ON, your vehicle's brake system will not work normally. So you may experience an unexpected and dangerous situation during sudden braking. In this case, avoid high speed driving and abrupt braking. Have your vehicle checked by Authorized Kia Dealer as soon as possible.

Safety belt warning light



If the driver's safety belt is not fastened when the key is turned ON or if it is unfastened after the key is turned ON, the safety belt warning light blinks until the belt is fastened.

Safety belt warning chime (if equipped)

If the driver's safety belt is not fastened when the ignition key is turned ON or if it is unfastened after the key is ON, the safety belt warning chime will sound for approximately 6 seconds. At this time, if the safety belt is fastened, the chime will stop at once.

High beam indicator

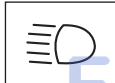

This indicator illuminates when the headlights are on and in the high beam position or when the turn signal lever is pulled into the Flash-to-Pass position.

Engine oil pressure warning



This warning light indicates the engine oil pressure is low.

If the warning light illuminates while driving:

1. Drive safely to the side of the road and stop.
2. With the engine off, check the engine oil level. If the level is low, add oil as required.

If the warning light remains on after adding oil or if oil is not available, call an Authorized Kia Dealer.

CAUTION
If the engine is not stopped immediately after the engine oil pressure warning light is illuminated, severe damage could result.

Parking brake & brake fluid warning



Parking brake warning

This light is illuminated when the parking brake is applied with the ignition switch in the START or ON position. The warning light should go off when the parking brake is released while engine is running.

Low brake fluid level warning

If the warning light remains on, it may indicate that the brake fluid level in the reservoir is low.

If the warning light remains on:

1. Drive carefully to the nearest safe location and stop your vehicle.
2. With the engine stopped, check the brake fluid level immediately and add fluid as required. Then check all brake components for fluid leaks.
3. Do not drive the vehicle if leaks are found, the warning light remains on or the brakes do not operate properly. Have it towed to any Authorized Kia Dealer for a brake system inspection and necessary repairs.

Features of your vehicle

To check bulb operation, check whether the parking brake and brake fluid warning light illuminates when the ignition switch is in the ON position.

⚠ WARNING

Driving the vehicle with a warning light on is dangerous. If the brake warning light remains on, have the brakes checked and repaired immediately by an authorized Kia Dealer.

Parking start warning chime

If you drive over 10 km/h (6 mph) with the parking brake applied, the parking start warning chime will sound.

Front fog light indicator (if equipped)

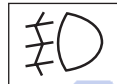

This light comes on when the front fog lights are ON.

Shift pattern indicators (if equipped)



The individual indicators illuminate to show the automatic transaxle shift lever selection.

Taillight indicator (if equipped)



This light comes on when the taillights are ON.

Charging system warning



This warning light indicates a malfunction of either the generator or electrical charging system.

If the warning light comes on while the vehicle is in motion:

1. Drive to the nearest safe location.
2. With the engine off, check the generator drive belt for looseness or breakage.
3. If the belt is adjusted properly, a problem exists somewhere in the electrical charging system. Have an Authorized Kia Dealer correct the problem as soon as possible.

Tailgate open warning light



This warning light comes on when the tailgate is not closed securely.

Door ajar warning light



This warning light illuminates when a door is not closed securely with the ignition in any position.

Door ajar warning chime

If a door or tailgate is opened while driving the vehicle over 10 km/h (6 mph), the warning chime will sound.

**Immobilizer indicator
(if equipped)**



This light illuminates when the immobilizer key is inserted and turned to the ON position to start the engine.

At this time, you can start the engine. The light goes out after the engine is running. If this light blinks when the ignition switch is in the ON position before starting the engine, have the system checked by an authorized Kia Dealer.

**Low fuel level
warning**



This warning light indicates the fuel tank is nearly empty. When it comes on, you should add fuel as soon as possible. Driving with the fuel level warning light on or with the fuel level below "E" can cause the engine to misfire and damage the catalytic converter.

**Malfunction indicator
lamp (MIL) (check
engine light)**





This indicator light is part of the Engine Control System which monitors various emission control system components. If this light illuminates while driving, it indicates that a potential problem has been detected somewhere in the emission control system.

Generally, your vehicle will continue to be drivable, but have the system checked by an authorized Kia Dealer promptly.

*** NOTICE**

A loose fuel filler cap may cause the On Board Diagnostic System Malfunction Indicator Light () in the instrument panel to illuminate unnecessarily. Always make sure that the fuel filler cap is tight.

CAUTION

- *Prolonged driving with the Emission Control System Malfunction Indicator Light () illuminated may cause damage to the emission control systems which could effect drivability and/or fuel economy.*
- *If the Emission Control System Malfunction Indicator Light () illuminates, potential catalytic converter damage is possible which could result in loss of engine power. Have the Engine Control System inspected as soon as possible by an authorized Kia Dealer.*

**Low washer fluid level
warning indicator**



This warning light indicates the washer fluid reservoir is near empty. Refill the washer fluid as soon as possible.

Features of your vehicle

ESC indicator (Electronic Stability Control) (if equipped)



The ESC indicator will illuminate when the ignition switch is turned ON, but should go off after approximately 3 seconds. When the ESC is on, it monitors the driving conditions and under normal driving conditions, the ESC light will remain off. When a slippery or low traction condition is encountered, the ESC will operate, and the ESC indicator will blink to indicate the ESC is operating.

ESC OFF indicator (if equipped)



The ESC OFF indicator will illuminate when the ignition switch is turned ON, but should go off after approximately 3 seconds. To switch to ESC OFF mode, press the ESC OFF button. The ESC OFF indicator will illuminate indicating the ESC is deactivated. If this indicator stays on in the ESC ON mode, the ESC may have a malfunction. Take your car to the authorized Kia dealer and have the system checked.

Cruise indicator (if equipped)

CRUISE indicator



The indicator light illuminates when the cruise control system is enabled.

Cruise SET indicator



The indicator light illuminates when the cruise function switch (COAST/SET or RES/ACCEL) is ON.

Lights on warning chime

The lights on warning chime will sound if the headlight switch is left in the 1st or 2nd position and the driver's door is opened.

Key reminder warning chime

If the driver's door is opened while the ignition key is left in the ignition switch (ACC or LOCK position), the key reminder warning chime will sound. This is to prevent you from locking your keys in the vehicle.

INTERIOR LIGHTS



Map light

The lights are turned ON or OFF based on the status of the doors, main control switch and corresponding light switch.

Map lights operating logic

Main control switch status	Door open/close status	Map light switch	
		ON (depressed)	DOOR (not depressed)
OFF	Any	ON	OFF
DOOR	Open or Close → Open	ON	Lamp turns ON, then turns OFF after about 20 minutes* ¹⁾
	Close	ON	OFF* ²⁾
	Open → Close	ON	Lamp dims gradually over a 5-second period* ³⁾
ON ()	Any	ON	

¹⁾ If other door is opened while the light stays off after about 20 minutes, the light stays on again for about 20 minutes.

²⁾ When a door is unlocked by the transmitter, the light stays on for about 30 seconds as long as any door is not opened. When the ignition switch is turned to the ACC or LOCK position, the light stays on for about 15 seconds.

³⁾ If the ignition switch is turned to the ON position, the light turns off immediately.

Features of your vehicle

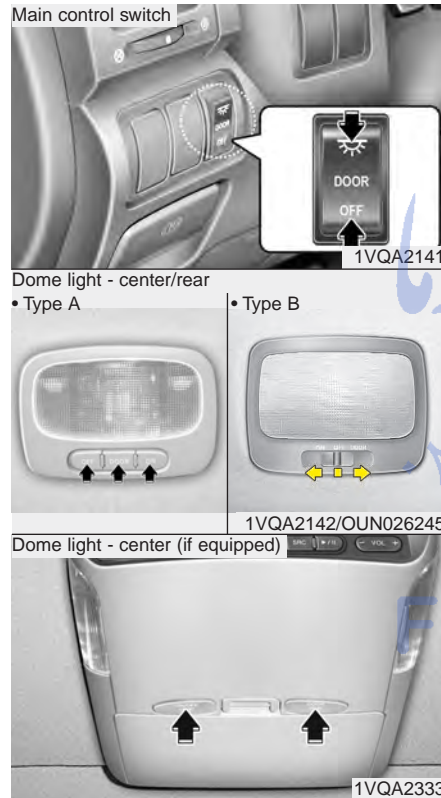

Dome light

The lights are turned ON or OFF based on the status of the doors, main control switch and corresponding light switch.

Dome lights operating logic

Main control switch status	Door open/close status	Dome light switch		
		ON	DOOR	OFF
OFF	Any	OFF		
DOOR	Open or Close → Open	ON	Lamp turns ON, then turns OFF after about 20 minutes* ¹⁾	OFF
	Close	ON	OFF* ²⁾	OFF
	Open → Close	ON	Lamp dims gradually over a 5-second period* ³⁾	OFF
ON (☀)	Any	ON		

¹⁾ If other door is opened while the light stays off after about 20 minutes, the light stays on again for about 20 minutes.

²⁾ When a door is unlocked by the transmitter, the light stays on for about 30 seconds as long as any door is not opened. When the ignition switch is turned to the ACC or LOCK position, the light stays on for about 15 seconds.

³⁾ If the ignition switch is turned to the ON position, the light turns off immediately.

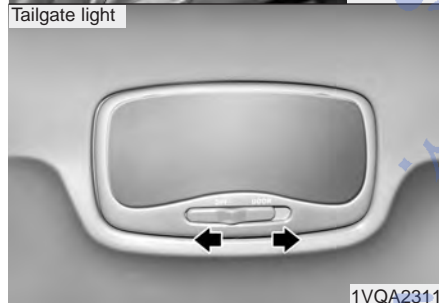

Tailgate light

The lights are turned ON or OFF based on the status of the tailgate, main control switch and corresponding light switch.

Tailgate light operating logic

Main control switch status	Tailgate open/ close status	Tailgate light switch	
		DOOR	OFF
OFF	Open	ON	OFF
	Close	OFF	
DOOR	Open or Close → Open	Lamp turns ON, then turns OFF after about 20 minutes	OFF
	Close or Open → Close	OFF	
ON ()	Any	ON	

Features of your vehicle



Door courtesy lamp (if equipped)

The door courtesy lamp comes ON when the door is opened to assist entering or exiting the vehicle. It also serves as a warning to passing vehicles that the vehicle door is open.



Glove box lamp

The glove box lamp comes ON when the glove box is opened.

The parking lights or headlights must be ON for the glove box lamp to function.

LIGHTING

Battery saver function

- The purpose of this feature is to prevent the battery from being discharged. The system automatically turns off the small light when the driver removes the ignition key and opens the driver-side door.
- With this feature, the parking lights will be turned off automatically if the driver parks on the side of road at night.

If necessary, to keep the lights on when the ignition key is removed, perform the following :

- 1) Open the driver-side door.
- 2) Turn the parking lights OFF and ON again using the light switch on the steering column.

Rescue mode function

If your vehicle has any problem on the vehicle network system, the headlights (low beam) and parking lights turn on automatically with the ignition switch in the ON position even though the headlight switch is not turned on. At this time, the emergency lighting is not turned off when the headlight switch is turned off.

CAUTION

If the rescue mode occurs, have your vehicle checked by an authorized Kia dealer as soon as possible.

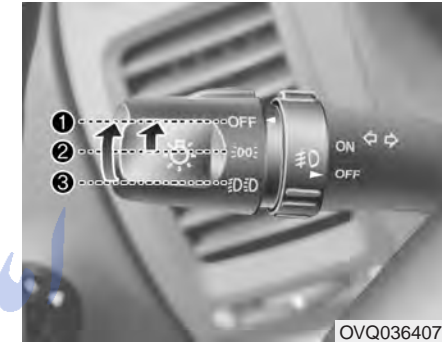

OVQ036407N

Lighting control

The light switch has a Headlight and a Parking light position.

To operate the lights, turn the knob at the end of the control lever to one of the following positions:

- (1) OFF position
- (2) Parking light position
- (3) Headlight position

Features of your vehicle



Parking light position (٤٠٤)

When the light switch is in the parking light position (1st position), the tail, position, license and instrument panel lights are ON.



Headlight position (٤٠٥)

When the light switch is in the headlight position (2nd position) the head, tail, position, license and instrument panel lights are ON.



High - beam operation

To turn on the high beam headlights, push the lever away from you. Pull it back for low beams.

The high-beam indicator will light when the headlight high beams are switched on.

To prevent the battery from being discharged, do not leave the lights on for a prolonged time while the engine is not running.



1VQA2133

Flashing headlights

To flash the headlights, pull the lever towards you. It will return to the normal (low-beam) position when released. The headlight switch does not need to be on to use this flashing feature.

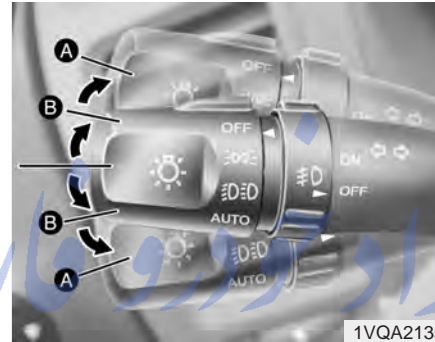

1VQA2135

Turn signals (A)

The ignition switch must be on for the turn signals to function. To turn on the turn signals, move the lever up or down. Green arrow indicators on the instrument panel indicate which turn signal is operating. They will self-cancel after a turn is completed. If the indicator continues to flash after a turn, manually return the lever to the OFF position.

Lane change signals (B)

To signal a lane change, move the turn signal lever slightly and hold it in position. The lever will return to the OFF position when released.

If an indicator stays on and does not flash or if it flashes abnormally, one of the turn signal bulbs may be burned out and will require replacement.

*** NOTICE**

If an indicator flash is abnormally quick or slow, bulb may be burned out or have a poor electrical connection in the circuit.



OVQ03690N

Front fog light (if equipped)

Fog lights are used to provide improved visibility and avoid accidents when visibility is poor due to fog, rain or snow etc. The fog lights will turn on when fog light switch (1) is turned to ON after the headlight is turned on.

To turn off the fog lights, turn the switch to OFF.

CAUTION

When in operation, the fog lights consume large amounts of vehicle electrical power. Only use the fog lights when visibility is poor or unnecessary battery and generator drain could occur.

Daytime running light (if equipped)

Daytime Running Lights (DRL) can make it easier for others to see the front of your vehicle during the day. DRL can be helpful in many different driving conditions, and it is especially helpful after dawn and before sunset.

The DRL system will make your high-beam headlights turn OFF when:

1. The head light switch is ON.
2. The parking brake engaged.
3. Engine stops.

WIPERS AND WASHERS

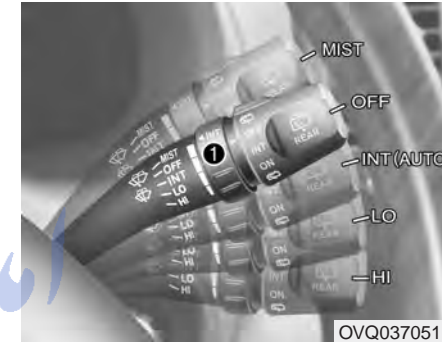

OVQ037051N

Windshield wipers

Operates as follows when the ignition switch is turned ON.

OFF : Wiper is not in operation

INT : Wiper operates intermittently at the same wiping intervals. Use this mode in a light rain or mist. To vary the speed setting, turn the speed control knob (1).

LO : Normal wiper speed

HI : Fast wiper speed

MIST: For a single wiping cycle, push the lever upward and release it with the lever in the OFF position. The wipers will operate continuously if the lever is pushed upward and held.

*** NOTICE**

If there is heavy accumulation of snow or ice on the windshield, defrost the windshield for about 10 minutes, or until the snow and/or ice is removed before using the windshield wipers to ensure proper operation.



OVQ037052N

Auto control (if equipped)

The rain sensor located on the upper end of windshield glass senses the amount of rainfall and controls the wiping cycle for the proper intervals. The more it rains, the faster the wiper operates. When the rain stops, the wiper stops. To vary the speed setting, turn the speed control knob (1).

If the wiper switch is set in AUTO mode when the ignition switch is ON, or the speed control knob is turned toward the F position when the wiper switch is in AUTO mode, wiper will operate once to perform a self-check of the system. Set the wiper to OFF position when the wiper is not in use.

CAUTION

When washing the vehicle, set the wiper switch in the OFF position to stop the auto wiper operation.

Wiper may operate and be damaged if the switch is set in AUTO mode while washing vehicle.

Do not remove the sensor cover located on the upper end of the passenger side windshield glass. Damage to system parts could occur and may not be covered by you vehicle warranty.

When the starting the vehicle in winter, set the wiper switch in the OFF position. Otherwise, wipers may operate and ice may damage the windshield wiper blades. Always remove all snow and ice and defrost the windshield properly prior to operating the windshield wipers.

CAUTION

When the ignition switch is ON and the windshield wiper switch is placed in the AUTO mode, use caution in the following situations to avoid any injury to the hands or other parts of the body:

- *Do not touch the upper end of the windshield glass facing the rain sensor.*
- *Do not wipe the upper end of the windshield glass with a damp or wet cloth.*
- *Do not put pressure on the windshield glass.*

Variable intermittent wipers

Set the lever to the INT/AUTO position and choose the desired wiper interval by turning the ring(1).

One - touch wiper

For a single wiping cycle, push the lever upward and release it with the lever in the OFF position.

The wipers will operate continuously if the lever is pushed upward and held.

CAUTION

- *To prevent possible damage to the wipers or windshield, do not operate the wipers when the windshield is dry.*
- *To prevent damage to the wiper blades, do not use gasoline, kerosene, paint thinner, or other solvents on or near them.*
- *To prevent damage to the wiper arms and other components, do not attempt to move the wipers manually.*



Windshield washers

In the OFF position, pull the lever gently toward you to spray washer fluid on the windshield and to run the wipers 1-3 cycles.

Use this function when the windshield is dirty.

The spray and wiper operation will continue until you release the lever.

If the washer does not work, check the washer fluid level. If the fluid level is not sufficient, you will need to add appropriate non-abrasive windshield washer fluid to the washer reservoir.

The reservoir filler neck is located in the front of the engine compartment on the passenger side.

CAUTION

To prevent possible damage to the washer pump, do not operate the washer when the fluid reservoir is empty.



WARNING

Do not use the washer in freezing temperatures without first warming the windshield with the defrosters; the washer solution could freeze on contact with the windshield and obscure your vision.



Rear window wiper and washer switch (if equipped)

The rear window wiper and washer switch is located at the end of the wiper and washer switch lever. Turn the switch to desired position to operate the rear wiper and washer.

-  - Spraying washer fluid and wiping
- OFF - Wiper is not in operation
- INT - Intermittent wiper operation
- ON - Normal wiper operation
-  - Spraying washer fluid and wiping

HORN



To sound the horn, press the horn symbol on your steering wheel.

Check the horn regularly to be sure it operates properly.

CAUTION

- To sound the horn, press the area indicated by the horn symbol on your steering wheel (see illustration). The horn will operate only when this area is pressed.
- Do not strike the horn severely to operate it, or hit it with your fist. Do not press on the horn with a sharp-pointed object.

DEFROSTER



The defroster heats the window to remove frost, fog and thin ice from the interior and exterior of the rear window, while engine is running.

CAUTION

- To prevent damage to the conductors bonded to the inside surface of the rear window, never use sharp instruments or window cleaners containing abrasives to clean the window.
- If you want to defrost and defog on the front windshield, refer to “Windshield Defrosting and Defogging” in this section.

To activate the rear window defroster, press the rear window defroster button located in the center console switch panel. The indicator on the rear window defroster button illuminates when the defroster is ON.

If there is heavy accumulation of snow on the rear window, brush it off before operating the rear defroster.

The rear window defroster automatically turns off after 20 minutes or when the ignition switch is turned off. To turn off the defroster, press the rear window defroster button again.

Outside mirror defroster (if equipped)

If your vehicle is equipped with the outside mirror defroster, it will be operating at the same time when you operate the rear window defroster.

HAZARD WARNING FLASHER



* The location of the front windshield deicer button may be changed depending on your model.

Front windshield deicer (if equipped)

The engine must be running to enable this feature. To activate the front windshield deicer, press the front windshield deicer button. The indicator on the button illuminates when the deicer is ON. The front windshield deicer automatically turns off after 20 minutes or when the ignition switch is turned off. To turn off the deicer, press the front windshield deicer button again.



To activate the flasher, depress the hazard warning flasher switch. This switch operates in any ignition switch position. To turn the flashers off, depress the switch again.

The hazard warning flasher causes the front and rear turn signal lights to flash on and off, which serves as a warning to other drivers to exercise caution when approaching or passing your vehicle.

MANUAL CLIMATE CONTROL SYSTEM (IF EQUIPPED)



- | | |
|--|------------------------------------|
| 1. Driver's temperature control knob | 6. Rear window defroster button |
| 2. Passenger's temperature control knob | 7. Mode selection knob |
| 3. Front fan speed control knob | 8. Rear temperature control button |
| 4. Air conditioning button (if equipped) | 9. Rear fan speed control knob |
| 5. Air intake control button | |

OVQ036061N



OVQ036062N

Heating and ventilation (front)

Fan speed control knob

The ignition switch must be in the ON position for fan operation.

The fan speed control knob allows you to control the fan speed of the air flowing from the ventilation system. To change the fan speed, turn the knob to the right for higher speed or left for lower speed.

Setting the mode selection knob to the OFF position turns off the fan.



OVQ036063N

Air intake control button

This is used to select outside (fresh) air position or recirculated air position.

To change the air intake control position, push the control button.

Recirculated air position

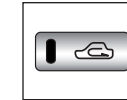

The indicator light on the button is illuminated when the recirculated air position is selected.

With the recirculated air position selected, air from passenger compartment will be drawn through the heating system and heated or cooled according to the function selected.

Outside (fresh) air position

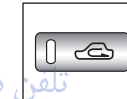

The indicator light on the button is not illuminated when the outside (fresh) air position is selected.

With the outside (fresh) air position selected, air enters the vehicle from outside and is heated or cooled according to the function selected.

*** NOTICE**

It should be noted that prolonged operation of the heating in recirculated air position will cause fogging of the windshield and side windows and the air within the passenger compartment will become stale.

In addition, prolonged use of the air conditioning with the “recirculated air position” selected, will result in excessively dry air in the passenger compartment.

⚠ WARNING

- Continued climate control system operation in the recirculated air position may allow humidity to increase inside vehicle which may fog the glass and obscure visibility.
- Do not sleep in a vehicle with air conditioning or heating system on. It may cause serious harm or death due to a drop in the oxygen level and/or body temperature.
- Continued climate control system operation in the recirculated air position can cause drowsiness or sleepiness, and loss of vehicle control. Set the air intake control to the outside (fresh) air position as much as possible while driving.



Temperature control knob

The temperature control knob allows you to control the temperature of the air flowing from the ventilation system. To change the air temperature in the passenger compartment, turn the knob to the WARM position for warm and hot air or COOL position for cooler air.

- Turn the left knob to control the driver side air temperature.
- Turn the right knob to control the passenger side air temperature.



Mode selection knob

The mode selection knob controls the direction of the air flow through the ventilation system.

The steps (•) between the air flow positions adjust the direction of the air flow to the middle position.

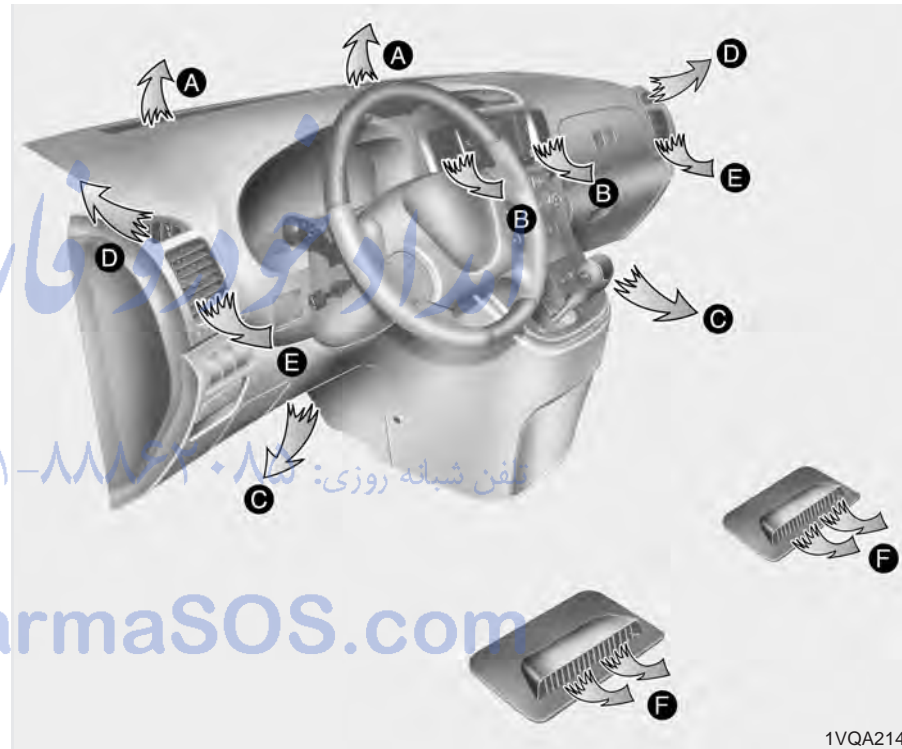

Outlet port locations

Features of your vehicle

MAX/ A/C position

**MAX
A/C**

When you select the MAX A/C mode while the fan speed is on, the following system settings will be made automatically;

- the air conditioning system will be turned on.
- the recirculated air position will be selected.
- the face mode will be selected.

If you select MAX A/C mode, you will not be able to cancel the A/C system operation, or change the recirculated air mode position.

Set the fan speed control knob to the desired speed and rotate the temperature control knob to the COOL position for maximum cooling. (outlet port : B, E)

Face position



Air flow is directed toward the upper body and face. Additionally, each outlet can be controlled to direct the air discharged from the outlet. (outlet port: B, E)

Face - floor position



Air flow is directed towards the face and the floor. (outlet port: B, C, E, F)

OFF position



The fan is turned off.

Floor position



Most of the air flow is directed to the floor, with a small amount of the air being directed to the windshield and side window defroster. (outlet port: A, C, D, E, F)

Floor - defrost position



Most of the air flow is directed to the floor and the windshield with a small amount directed to the side window defrosters. (outlet port: A, C, D, E, F)

Defrost position



Most of the air flow is directed to the windshield with a small amount of air directed to the side window defrosters. (outlet port: A, D, E)

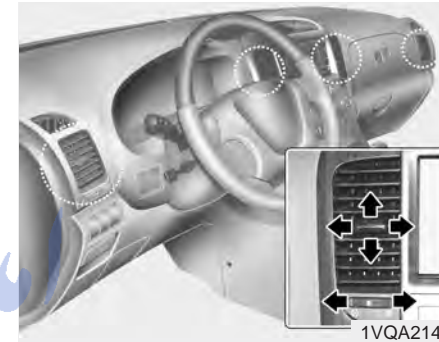

Instrument panel vents

If air flow control is not satisfactory, check the instrument panel vents. The outlet port (B, E) can be opened or closed separately using the horizontal thumbwheel. To close the vent, rotate it left to the maximum position. To open the vent, rotate it right to the desired position.

Also, you can adjust the direction of air delivery from these vents using the vent control lever as shown.



**Air conditioning button
(if equipped)**

Push the A/C button to turn the air conditioning system on (indicator light will illuminate). Push the button again to turn the air conditioning system off.

OVQ036066N

■ Front



1. Rear fan speed control knob (from front seat)
2. Rear temperature control button (from front seat)
3. Rear fan speed control knob (from rear seat)
4. Rear mode selection button (from rear seat)
5. Rear temperature control button (from rear seat)

■ Rear



Farmacos.com

1VQA2335/1VQA2168

Heating and ventilation (rear)

Temperature, fan speed and mode of the rear climate control system can be controlled independently regardless of the front climate control system operation.

However, the front climate control system should be operated together for rear air conditioning;

1. Set the front fan speed to the desired position.
2. Push the air conditioning button.
3. Set the rear temperature, fan speed and mode to the desired position.



Rear fan speed control

From front seat

Set the rear fan speed control (REAR) knob in the front climate control panel to the desired position (except R and 0 positions).

To change the rear fan speed, turn the knob to the right for higher speed or left for lower speed.

Setting the knob to the OFF(0) position turns off the rear fan.



From rear seat

Set the rear fan speed control (REAR) knob in the front climate control panel to the R position and set the rear fan speed control knob on the rear control panel to the desired position.

To change the rear fan speed, turn the knob to the right for higher speed or left for lower speed.

Setting the knob to the OFF(0) position turns off the rear fan.



OVQ036068N

Rear temperature control

From front seat

Set the rear fan speed control (REAR) knob in the front climate control panel to the desired position (except R and 0 positions), and set the rear temperature control in the front climate control panel to the desired position.

To change the rear air temperature, push the upper part ▲ of the button for warmer air or push the lower part ▼ of the button for cooler air.

The lights located to the right of the rear temperature control will illuminate to indicate the selected outlet temperature range.



1VQA2172

From rear seat

Set the rear fan speed control (REAR) knob in the front climate control panel to the R position and turn the rear temperature control knob on the rear control panel to the desired position.

To change the rear air temperature, turn the knob to the right for warmer air or left for cooler air.

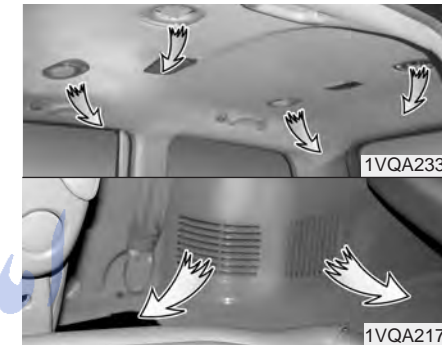









1VQA2338

1VQA2174



Rear mode selection

When the rear fan speed control (REAR) knob in the front climate control panel is in any position (except R and 0 positions), the rear mode is selected automatically depending on the mode of the front climate control as follows:

- Front climate control is MAX A/C,  or  :
Rear air blows from the upper vents on the rear ceiling.
- Front climate control is  or  :
Rear air blows from the upper vents on the rear ceiling and the lower vents on the right rear trim together.
- Front climate control is OFF, , , ,  :
Rear air blows from the lower vents on the right rear trim.



When the rear fan speed control (REAR) knob in the front climate control panel is in the R position, the rear mode is selected by pushing the rear mode selection button on the rear control panel as follows:

-  : Rear air blows from the upper vents on the rear ceiling.
-  : Rear air blows from the upper vents on the rear ceiling and the lower vents on the right rear trim together.
-  : Rear air blows from the lower vents on the right rear trim.



Rear vents

If air flow control is not satisfactory, check the rear vents on the rear ceiling.

The vent can be opened or closed separately using the control lever. To close the vent, move it to the close position (⊗). To open the vent, move it to the open position (☼).



Also, you can adjust the direction of air delivery from these vents by moving the blade.

System operation

Ventilation

1. Set the mode to the  position.
2. Set the air intake control to the outside (fresh) air position.
3. Set the temperature control to the desired position.
4. Set the fan speed control to the desired speed.

Heating

1. Set the mode to the  position.
2. Set the air intake control to the outside (fresh) air position.
3. Set the temperature control to the desired position.
4. Set the fan speed control to the desired speed.
5. If dehumidified heating is desired, turn the air conditioning system (if equipped) on.
- If the windshield fogs up, set the mode to the  ,  position.

Air conditioning (if equipped)

All Kia Air Conditioning Systems are filled with environmentally friendly R-134a refrigerant which is not damaging to the ozone layer.

1. Start the engine. Push the air conditioning button.
2. Set the mode to the  position.
3. Set the air intake control to the outside air or recirculated air position.
4. Set the temperature control to the desired position.
5. Set the fan speed control to the desired speed.
6. Adjust the fan speed control and temperature control to maintain maximum comfort.
- When maximum cooling is desired, set the temperature control to the COOL position, set the air intake control to the recirculated air position, then set the fan speed control to the highest speed.

CAUTION

- *When using the air conditioning system, monitor the temperature gauge closely while driving up hills or in heavy traffic when outside temperatures are high. Air conditioning system operation may cause engine overheating. Continue to use the blower fan but turn the air conditioning system off if the temperature gauge indicates engine overheating.*
- *When opening the windows in humid weather air conditioning may create water droplets inside the vehicle. Since excessive water droplets may cause damage to electrical equipment, air conditioning should only be run with the windows closed.*

Features of your vehicle

Air conditioning system operation tips

- If the vehicle has been parked in direct sunlight during hot weather, open the windows for a short time to let the hot air inside the vehicle escape.
- To help reduce moisture inside of windows on rainy humid days, decrease the humidity inside the vehicle by operating the air conditioning system.
- During air conditioning system operation, you may occasionally notice a slight change in engine speed as the air conditioning compressor cycles on. This is a normal system operation characteristics.
- Use the air conditioning system every month if only for a few minutes to ensure maximum system performance.
- When using the air conditioning system, you may notice clear water dripping (or even puddling) on the ground under the passenger side of the vehicle. This is a normal system operation characteristics.
- Operating the air conditioning system in the recirculated air position does provide maximum cooling, however, continual operation in this mode may cause the air inside the vehicle to become stale.

Checking the amount of air conditioner refrigerant and compressor lubricant

When the amount of refrigerant is low, the performance of the air conditioning is reduced. Overfilling also has a bad influence on the air conditioning system.

Therefore, if abnormal operation is found, have the system inspected by an authorized Kia dealer.

CAUTION

The air conditioning system should be serviced by an authorized Kia dealer. Improper service may cause serious injury.

CAUTION

When the performance of the air conditioning system is reduced it is important that the correct type and amount of oil and refrigerant is used. Otherwise, damage to the compressor and abnormal system operation may occur.

تلفن شبانه روزی: ۰۸۵-۸۸۶۲۰۸۱

PharmaSOS.com

AUTOMATIC CLIMATE CONTROL SYSTEM (IF EQUIPPED)



- | | | |
|--|-------------------------------------|---------------------------------|
| 1. AUTO (automatic control) button | 6. Front fan speed control knob | 11. Rear fan speed control knob |
| 2. Driver's temperature control button | 7. Mode selection button | 12. OFF button |
| 3. A/C display | 8. Front windshield defrost button | 13. Air conditioning button |
| 4. Passenger's temperature control button | 9. Recirculated air position button | 14. Rear window defrost button |
| 5. Dual temperature control selection button | 10. Rear temperature control button | 15. Outside air position button |

OVQ036069N

Features of your vehicle



Automatic operation

The automatic climate control system is controlled by simply setting the desired temperature.

The Full Automatic Temperature Control (FATC) system automatically controls the heating and cooling system as follows;

1. Push the AUTO button. It is indicated by AUTO on the display. The modes, fan speeds, air intake and air-conditioning will be controlled automatically by temperature setting.

2. Push the TEMP button to set the desired temperature.

If the temperature is set to the lowest setting LO (17°C/62°F), the air conditioning system will operate continuously.

3. To turn the automatic operation off, press any button except temperature control button. If you press the mode selection button, air-conditioning button, defrost button, air intake control button or fan speed knob, the selected function will be controlled manually while other functions operate automatically.

Regardless of the temperature setting, when using automatic operation, the air conditioning system can automatically turn on to decrease the humidity inside the vehicle, even if the temperature is set to warm.

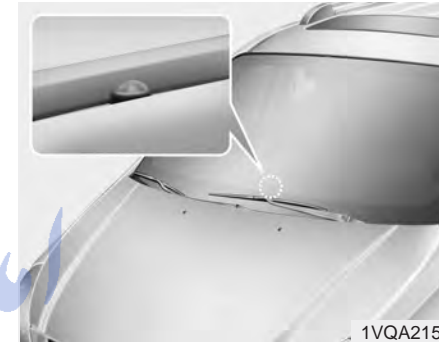

CAUTION

Never place anything over the sensor located on the instrument panel to ensure better control of the heating and cooling system.

Manual operation

The heating and cooling system can be controlled manually as well by pushing buttons other than the AUTO button. In this case, the system works sequentially according to the order of buttons selected.

When pressing any button except AUTO button while automatic operation, the functions of the buttons not selected will be controlled automatically.

Press the AUTO button in order to convert to full automatic control of the system.

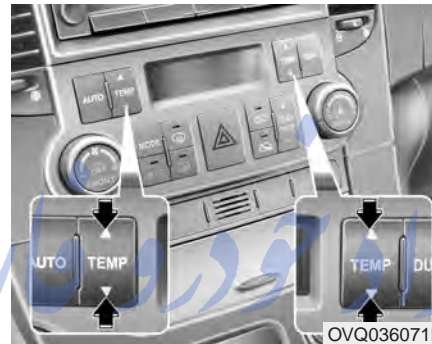

Temperature control button

The temperature will increase to the maximum 32°C/90°F (HI) by pushing the up button. Each push of the button will cause the temperature to increase by 0.5°C/1°F. The temperature will decrease to the minimum 17°C/62°F (LO) by pushing the down button. Each push of the button will cause the temperature to decrease by 0.5°C/1°F. When set to the lowest temperature setting, the air conditioning will operate continuously.



Dual temperature control selection button

Adjusting the driver and passenger side temperature individually

1. Press the DUAL button to operate the driver and passenger side temperature individually. Pressing the right temperature control button will automatically switch to the DUAL mode as well.
2. Press the left temperature control to adjust the driver side temperature. Press the right temperature control to adjust the passenger side temperature.

Features of your vehicle

Adjusting the driver and passenger side temperature equally

1. Press the DUAL button again to deactivate DUAL mode. The passenger side temperature will be set to the same as the driver side temperature.
2. Press the left temperature control button. The driver and passenger side temperature will be adjusted equally.

Temperature conversion

If the battery has been discharged or disconnected, the temperature mode display will reset to Fahrenheit.

This is normal condition. You can switch the temperature mode between Fahrenheit to Centigrade as follows;

While depressing the AUTO button, depress the OFF button for 3 seconds or more. The display will change from Fahrenheit to Centigrade, or from Centigrade to Fahrenheit.



Fan speed control knob

The fan speed can be set to the desired speed by turning the fan speed control knob.

The higher the fan speed is, the more air is delivered.

Pressing the OFF button turns off the fan.



Air intake control button

This is used to select outside (fresh) air position or recirculated air position.

To change the air intake control position, push the control button.

FarmaSOS.com

Recirculated air position



The indicator light on the button is illuminated when the recirculated air position is selected.

With the recirculated air position selected, air from passenger compartment will be drawn through the heating system and heated or cooled according to the function selected.

Outside (fresh) air position



The indicator light on the button is illuminated when the outside (fresh) air position is selected.

With the outside (fresh) air position selected, air enters the vehicle from outside and is heated or cooled according to the function selected.

*** NOTICE**

It should be noted that prolonged operation of the heating in recirculated air position will cause fogging of the windshield and side windows and the air within the passenger compartment will become stale.

In addition, prolonged use of the air conditioning with the “recirculated air position” selected, will result in excessively dry air in the passenger compartment.

⚠ WARNING

- Continued climate control system operation in the recirculated air position may allow humidity to increase inside vehicle which may fog the glass and obscure visibility.
- Do not sleep in a vehicle with air conditioning or heating system on. It may cause serious harm or death due to a drop in the oxygen level and/or body temperature.
- Continued climate control system operation in the recirculated air position can cause drowsiness or sleepiness, and loss of vehicle control. Set the air intake control to the outside (fresh) air position as much as possible while driving.



Defrost button

Most of the air flow is directed to the windshield with a small amount of air directed to the side window defrosters. (outlet port: A, D, E)

Features of your vehicle



Mode selection button

The mode selection button controls the direction of the air flow through the ventilation system.

The air flow outlet port is converted as follows:

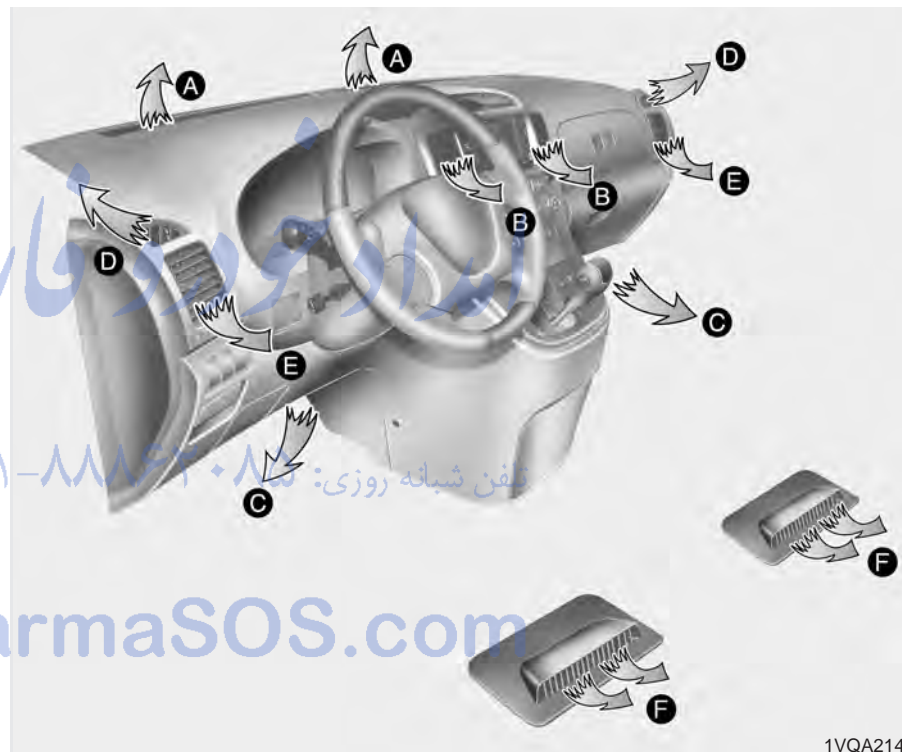

Outlet port locations

1VQA2147

Face position



Air flow is directed toward the upper body and face. Additionally, each outlet can be controlled to direct the air discharged from the outlet. (outlet port: B, E)

Face - floor position



Air flow is directed towards the face and the floor. (outlet port: B, C, E, F)

Floor position



Most of the air flow is directed to the floor, with a small amount of the air being directed to the windshield and side window defroster. (outlet port: A, C, D, E, F)

Floor - defrost position



Most of the air flow is directed to the floor and the windshield with a small amount directed to the side window defrosters. (outlet port: A, C, D, E, F)

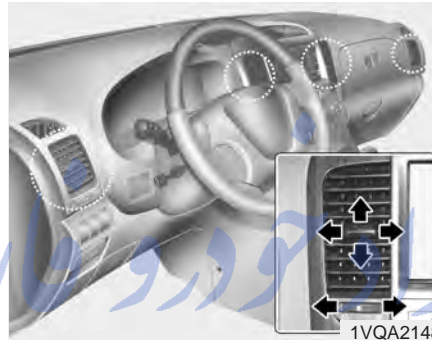

Instrument panel vents

If air flow control is not satisfactory, check the instrument panel vents. The outlet port (B, E) can be opened or closed separately using the horizontal thumbwheel. To close the vent, rotate it left to the maximum position. To open the vent, rotate it right to the desired position.

Also, you can adjust the direction of air delivery from these vents using the vent control lever as shown.



Air conditioning button

Push the A/C button to turn the air conditioning system on (indicator light will illuminate).

Push the button again to turn the air conditioning system off.

Features of your vehicle



OFF button

Push the OFF button to turn off the air climate control system. However you can still operate the mode and air intake buttons as long as the ignition switch is ON.

■ Front



1. Rear fan speed control knob (from front seat)
2. Rear temperature control button (from front seat)
3. Rear fan speed control knob (from rear seat)
4. Rear mode selection button (from rear seat)
5. Rear temperature control button (from rear seat)

■ Rear



1VQH2167N/1VQA2168

Heating and ventilation (rear)

Temperature, fan speed and mode of the rear climate control system can be controlled independently regardless of the front climate control system operation.

However, the front climate control system should be operated together for rear air conditioning;

1. Set the front fan speed to the desired position.
2. Push the air conditioning button.
3. Set the rear temperature, fan speed and mode to the desired position.



Rear fan speed control

From front seat

Set the rear fan speed control (REAR) knob in the front climate control panel to the desired position (except R and 0 positions).

To change the rear fan speed, turn the knob to the right for higher speed or left for lower speed.

Setting the knob to the OFF(0) position turns off the rear fan.



From rear seat

Set the rear fan speed control (REAR) knob in the front climate control panel to the R position and set the rear fan speed control knob on the rear control panel to the desired position.

To change the rear fan speed, turn the knob to the right for higher speed or left for lower speed.

Setting the knob to the OFF(0) position turns off the rear fan.



Rear temperature control

From front seat

Set the rear fan speed control (REAR) knob in the front climate control panel to the desired position (except R and 0 positions), and set the rear temperature control in the front climate control panel to the desired position.

To change the rear air temperature, push the upper part ▲ of the button for warmer air or push the lower part ▼ of the button for cooler air.



From rear seat

Set the rear fan speed control (REAR) knob in the front climate control panel to the R position and turn the rear temperature control knob on the rear control panel to the desired position.

To change the rear air temperature, turn the knob to the right for warmer air or left for cooler air.

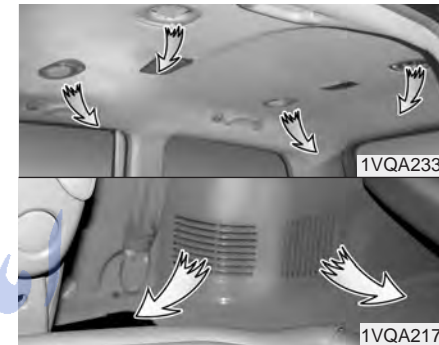



Rear mode selection

When the rear fan speed control (REAR) knob in the front climate control panel is in the any position (except R and 0 positions), the rear mode is selected automatically depending on the mode of the front climate control as follows:

- Front climate control is : Rear air blows from the upper vents on the rear ceiling.
- Front climate control is : Rear air blows from the upper vents on the rear ceiling and the lower vents on the right rear trim together.
- Front climate control is , , : Rear air blows from the lower vents on the right rear trim together.



When the rear fan speed control (REAR) knob in the front climate control panel is in the R position, the rear mode is selected by pushing the rear mode selection button on the rear control panel as follows:

-  : Rear air blows from the upper vents on the rear ceiling.
-  : Rear air blows from the upper vents on the rear ceiling and the lower vents on the right rear trim together.
-  : Rear air blows from the lower vents on the right rear trim together.



Rear vents

If air flow control is not satisfactory, check the rear vents on the rear ceiling.

The vent can be opened or closed separately using the control lever. To close the vent, move it to the close position (⊗). To open the vent, move it to the open position (⊕).



Also, you can adjust the direction of air delivery from these vents by moving the blade.

System operation

Ventilation

1. Set the mode to the  position.
2. Set the air intake control to the outside (fresh) air position.
3. Set the temperature control to the desired position.
4. Set the fan speed control to the desired speed.

Heating

1. Set the mode to the  position.
2. Set the air intake control to the outside (fresh) air position.
3. Set the temperature control to the desired position.
4. Set the fan speed control to the desired speed.
5. If dehumidified heating is desired, turn the air conditioning system on.
 - If the windshield fogs up, set the mode to the  ,  position.

Features of your vehicle

Air conditioning

All Kia Air Conditioning Systems are filled with environmentally friendly R-134a refrigerant which is not damaging to the ozone layer.

1. Start the engine. Push the air conditioning button.
 2. Set the mode to the  position.
 3. Set the air intake control to the outside air or recirculated air position.
 4. Set the temperature control to the desired position.
 5. Set the fan speed control to the desired speed.
 6. Adjust the fan speed control and temperature control to maintain maximum comfort.
- When maximum cooling is desired, set the temperature control to the minimum LO (17°C/62°F) and set the air intake to the recirculated air position, then set the fan speed control to the highest speed.

CAUTION

- ***When using the air conditioning system, monitor the temperature gauge closely while driving up hills or in heavy traffic when outside temperatures are high. Air conditioning system operation may cause engine overheating. Continue to use the blower fan but turn the air conditioning system off if the temperature gauge indicates engine overheating.***
- ***When opening the windows in humid weather air conditioning may create water droplets inside the vehicle. Since excessive water droplets may cause damage to electrical equipment, air conditioning should only be run with the windows closed.***

Air conditioning system operation tips

- If the vehicle has been parked in direct sunlight during hot weather, open the windows for a short time to let the hot air inside the vehicle escape.
- To help reduce moisture inside of windows on rainy humid days, decrease the humidity inside the vehicle by operating the air conditioning system.
- During air conditioning system operation, you may occasionally notice a slight change in engine speed as the air conditioning compressor cycles on. This is a normal system operation characteristics.
- Use the air conditioning system every month if only for a few minutes to ensure maximum system performance.
- When using the air conditioning system, you may notice clear water dripping (or even puddling) on the ground under the passenger side of the vehicle. This is a normal system operation characteristics.
- Operating the air conditioning system in the recirculated air position does provide maximum cooling, however, continual operation in this mode may cause the air inside the vehicle to become stale.

Checking the amount of air conditioner refrigerant and compressor lubricant

When the amount of refrigerant is low, the performance of the air conditioning is reduced. Overfilling also has a bad influence on the air conditioning system.

Therefore, if abnormal operation is found, have the system inspected by an authorized Kia dealer.

CAUTION

The air conditioning system should be serviced by an authorized Kia dealer. Improper service may cause serious injury.

CAUTION

When the performance of the air conditioning system is reduced it is important that the correct type and amount of oil and refrigerant is used. Otherwise, damage to the compressor and abnormal system operation may occur.

تلفن شبانه روزی: ۰۲۱-۸۸۸۶۲۰۸۵

FarmaSOS.com

WINDSHIELD DEFROSTING AND DEFOGGING

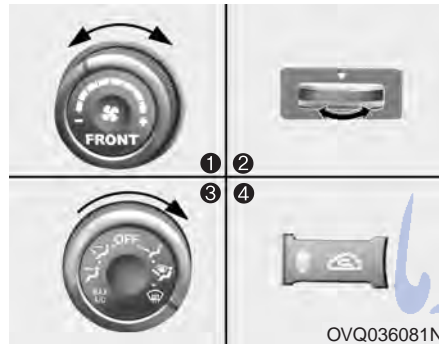

Manual climate control system

To defog inside windshield

1. Select any fan speed.
2. Select desired temperature.
3. Select the or position.
4. The outside (fresh) air will be selected automatically.

If the outside (fresh) air position are not selected automatically, press the corresponding button manually.

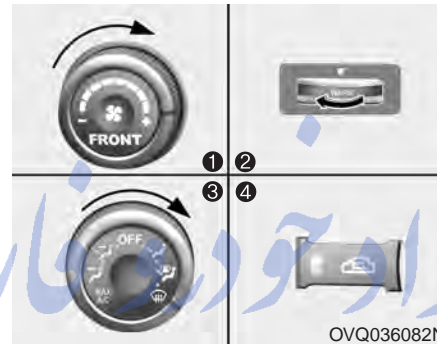

To defrost outside windshield

1. Set the fan speed to the highest (extreme right) position.
2. Set the temperature to the extreme hot position.
3. Select the position.
4. The outside (fresh) air will be selected automatically.

⚠ WARNING

Do not use the or position during cooling operation in extremely humid weather. The difference between the temperature of the outside air and that of the windshield could cause the outer surface of the windshield to fog up, causing loss of visibility. In this case, set the mode selection knob to the position and fan speed control knob to the lower speed.

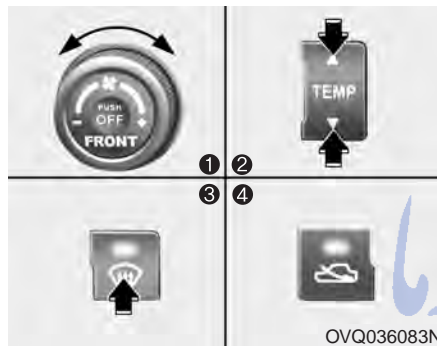

OVQ036083N

Automatic climate control system

To defog inside windshield

1. Select desired fan speed.
2. Select desired temperature.
3. Press the defrost button ().
4. The outside (fresh) air position will be selected automatically.

If the outside (fresh) air position are not selected automatically, adjust the corresponding button manually.





OVQ036304N

To defrost outside windshield

1. Set fan speed to the highest (extreme right) position.
2. Set temperature to the extreme hot (HI) position.
3. Press the defrost button ().
4. The outside (fresh) air position will be selected automatically.

⚠ WARNING







Do not use the  or  position during cooling operation in extremely humid weather. The difference between the temperature of the outside air and that of the windshield could cause the outer surface of the windshield to fog up, causing loss of visibility. In this case, set the mode selection knob to the  position and fan speed control knob to the lower speed.

- For maximum defrosting, set the temperature control to the extreme highest temperature setting and the fan speed control to the highest speed.
- If warm air to the floor is desired while defrosting or defogging, set the mode to the floor-defrost position.
- Before driving, clear all snow and ice from the windshield, rear window, outside rear view mirrors, and all side windows.
- Clear all snow and ice from the hood and air inlet in the cowl grill to improve heater and defroster efficiency and to reduce the probability of fogging up inside of the windshield.

Defogging logic

Manual climate control system



To reduce the probability of fogging up the inside of the windshield, the air intake control is set to the outside (fresh) air position automatically if any of following occur.

- The mode is selected to the ,  or  while the system is activated.
- The ignition switch is turned on while the mode is selected to the ,  or .
- The ignition switch is turned off.
- The fan is off.
- The fan begins to be operated.

Press the air intake control button to select the recirculated air position while the ignition switch is on.



How to cancel or return defogging logic of manual climate control system





1. Turn the ignition switch to the "ON" position.
2. Turn the mode selection knob to the defrost position () .
3. Push the air intake control button () at least 5 times within 3 seconds.

The indicator light in the air intake control button () will blink 3 times with 0.5 second of interval. It indicates that the defogging logic is canceled or returned to the programmed status.

If the battery has been discharged or disconnected, it is reset as the defog logic status.

Automatic climate control system

To reduce the probability of fogging up inside of the windshield, the air intake control is set to outside (fresh) air position automatically if any of following occur.

- The ignition switch is turned on while the mode is selected to the ,  or .
- The OFF button is pushed.
- The mode is selected to the  or  position.

Press the air intake control button to select the recirculated air position while the ignition switch is on.

LUGGAGE NET HOLDER (IF EQUIPPED)

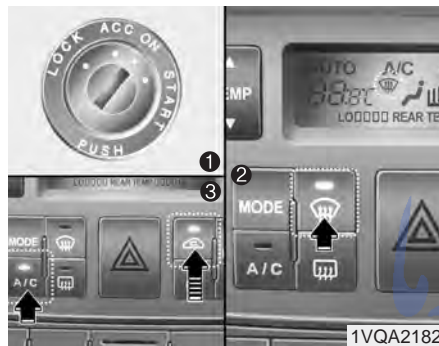

How to cancel or return defogging logic of automatic climate control system

1. Turn the ignition switch to the "ON" position.
2. Select the defrost position pressing defrost button (❄️).
3. While holding the air conditioning button (A/C) pressed, press the air intake control button (🚗) at least 5 times within 3 seconds.

The display panel blinks 3 times with 0.5 second of interval. It indicates that the defogging logic is canceled or returned to the programmed status.

If the battery has been discharged or disconnected, it is reset as the defog logic status.

To keep items from shifting in the cargo area, you can use the four holders located in the cargo area to attach the luggage net.

Contact your authorized Kia dealer تلفن شماره ۰۲۰۸۸۸۸۸۸۸ to obtain a luggage net.

FarmaSOS.com

ROOF RACK (IF EQUIPPED)



1VQA2206

If the vehicle has a roof rack, you can load cargo on top of your vehicle. Crossbars and fixing components needed to install the roof rack on your vehicle may be obtained from an authorized Kia dealer.

CAUTION

- *The crossbars should be placed in the proper load carrying positions prior to placing items onto the roof rack.*
- *If the vehicle is equipped with a sunroof, be sure not to position cargo onto the roof rack in such a way that it could interfere with sunroof operation.*

(Continued)

(Continued)

- *When carrying cargo on the roof rack, take the necessary precautions to make sure the cargo does not damage the roof of the vehicle.*
- *When carrying large objects on the roof rack, make sure they do not exceed the overall roof length or width.*

WARNING

- *The following specification is the maximum weight that can be loaded onto the roof rack. Distribute the load as evenly as possible across the crossbars and roof rack and secure the load firmly.*

ROOF RACK	75 kg (165 lbs.) EVENLY DISTRIBUTED
-----------	--

- *The vehicle center of gravity will be higher when items are loaded onto the roof rack. Avoid sudden starts, braking, sharp turns, abrupt maneuvers or high speeds that may result in loss of vehicle control or rollover causing an accident.*

(Continued)

(Continued)

- *Always drive slowly and turn corners carefully when carrying items on the roof rack. Severe wind updrafts, caused by passing vehicles or natural causes, can cause sudden upward pressure on items loaded on the roof rack. This is especially true when carrying large, flat items such as wood panels or mattresses. This could cause the items to fall off the roof rack and cause damage to your vehicle or those around you.*
- *To prevent damage or loss of cargo while driving, check frequently before or while driving to make sure the items on the roof rack are securely fastened.*

CAUTION

- *If the vehicle has a sunroof, do not position the roof rack loads so that they could not interfere with the sunroof.*
- *Loading cargo or luggage above specification on the roof rack may damage your vehicle.*

HOMELINK® WIRELESS CONTROL SYSTEM (IF EQUIPPED)

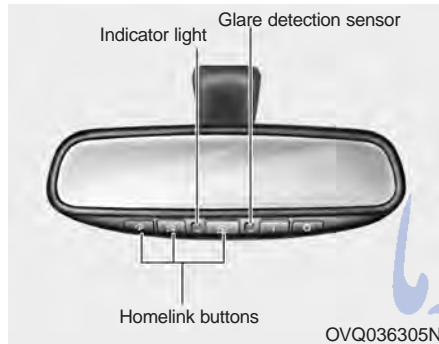

Your new mirror comes with an integrated HomeLink Universal Transceiver, which allows you to program the mirror to activate your garage door(s), estate gate, home lighting, etc. The mirror actually learns the codes from your various existing transmitters.

⚠ WARNING

- When programming the HomeLink® Wireless Control System, you may be operating a garage door or gate operator. Make sure that people and objects are out of the way of the moving door or gate to prevent potential harm or damage.

(Continued)

(Continued)

- Do not use HomeLink with any garage door opener that lacks the safety stop and reverse feature as required by federal safety standards. (This includes any garage door opener model manufactured before April 1, 1982.) A garage door opener which cannot detect an object, signaling the door to stop and reverse, does not meet current federal safety standards. Using a garage door opener without these features increases risk of serious injury or death. For more information, call 1-800-355-3515 or on the internet at www.homelink.com.
- Retain the original transmitter for future programming procedures (i.e., new vehicle purchase). It is also suggested that upon the sale of the vehicle, the programmed HomeLink buttons be erased for security purposes (follow step 1 in the “Programming” portion of this text).



Programming

Your vehicle may require the ignition switch to be turned to the ACC position for programming and/or operation of HomeLink. It is also recommended that a new battery be replaced in the hand-held transmitter of the device being programmed to HomeLink for quicker training and accurate transmission of the radio-frequency.

Follow these steps to train your HomeLink mirror:

Features of your vehicle



1. When programming the buttons for the first time, press and hold the left and center buttons ( , ) simultaneously until the indicator light begins to flash after approximately 20 seconds. (This procedure erases the factory-set default codes. Do Not perform this step to program additional hand-held transmitters.)

* NOTICE

For non rolling code garage door openers, follow steps 2 - 3.
For rolling code garage door openers, follow steps 2 - 6.
For Canadian Programming, please follow the Canadian Programming section. For help with determining whether your garage is non-rolling code or rolling code, please refer to the garage door opener's manual or contact HomeLink customer service at 1-800-355-3515.

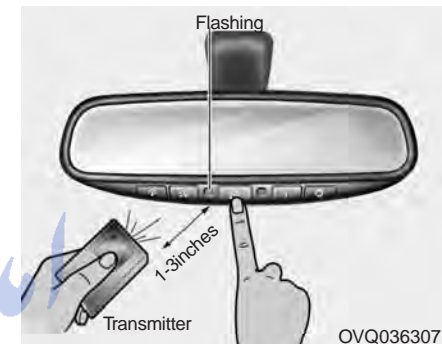

2. Press and hold the button on the HomeLink system you wish to train and the button on the transmitter while the transmitter is approximately 1 to 3 inches away from the mirror. Do not release the buttons until step 3 has been completed.
3. The HomeLink indicator light will flash, first slowly and then rapidly. When the indicator light flashes rapidly, both buttons may be released. (The rapid flashing light indicates successful programming of the new frequency signal.)

* NOTICE

Some gate operators and garage door openers may require you to replace step #3 with the "cycling" procedure noted in the "Canadian Programming" section of this document.

Rolling code programming

To train a garage door opener (or other rolling code equipped devices) with the rolling code feature, follow these instructions after completing the "Programming" portion of this text. (A second person may make the following training procedures quicker & easier.)

4. Locate the "learn" or "smart" button on the device's motor head unit. Exact location and color of the button may vary by product brand. If there is difficulty locating the "learn" or "smart" button, reference the device's owner's manual or contact HomeLink at 1-800-355-3515 or on the internet at www.homelink.com.
5. Press and release the "learn" or "smart" button on the device's motor head unit. You have 30 seconds to complete step number 6.
6. Return to the vehicle and firmly press and release the programmed HomeLink button up to three times. The rolling code equipped device should now recognize the HomeLink signal and activate when the HomeLink button is pressed. The remaining two buttons may now be programmed if this has not previously been done. Refer to the "Programming" portion of this text.

Operating HomeLink

To operate, simply press the programmed HomeLink button. Activation will now occur for the trained product (garage door, security system, entry door lock, estate gate, or home or office lighting). For convenience, the hand-held transmitter of the device may also be used at any time. The HomeLink Wireless Controls System (once programmed) or the original hand-held transmitter may be used to activate the device (e.g. garage door, entry door lock, etc.). In the event that there are still programming difficulties, contact HomeLink at 1-800-355-3515 or on the internet at www.homelink.com.



Erasing programmed HomeLink buttons

To erase the three programmed buttons (individual buttons cannot be erased):

- Press and hold the left and center buttons simultaneously, until the indicator light begins to flash (approximately 20 seconds). Release both buttons. Do not hold for longer than 30 seconds.

HomeLink is now in the train (or learning) mode and can be programmed at any time.

Reprogramming a single HomeLink button

To program a device to HomeLink using a HomeLink button previously trained, follow these steps:

1. Press and hold the desired HomeLink button. Do NOT release until step 4 has been completed.
2. When the indicator light begins to flash slowly (after 20 seconds), position the hand-held transmitter 1 to 3 inches away from the HomeLink surface.
3. Press and hold the hand-held transmitter button (or press and “cycle” - as described in “Canadian Programming” above).
4. The HomeLink indicator light will flash, first slowly and then rapidly. When the indicator light begins to flash rapidly, release both buttons.

The previous device has now been erased and the new device can be activated by pushing the HomeLink button that has just been programmed. This procedure will not affect any other programmed HomeLink buttons.

Gate operator programming & canadian programming

During programming, your hand-held transmitter may automatically stop transmitting. Continue to press and hold the HomeLink button (note steps 2 through 4 in the “Programming” portion of this text) while you press and re-press (“cycle”) your handheld transmitter every two seconds until the frequency signal has been learned. The indicator light will flash slowly and then rapidly after several seconds upon successful training.

CAUTION

If programming a garage door opener or gate, it is advised to unplug the device during the “cycling” process to prevent possible motor burn-up.

Accessories

If you would like additional information on the HomeLink Wireless Control System, HomeLink compatible products, or to purchase other accessories such as the HomeLink® Lighting Package, please contact HomeLink at 1-800-355-3515 or on the internet at www.homelink.com.

This device complies with Industry Canada Standard RSS-210. Operation is subject to the following two conditions:

1. This device may not cause interference, and
2. This device must accept any interference, including interference that may cause undesired operation of the device.

WARNING

Changes or modifications not expressly approved by the party responsible for compliance could void the user's authority to operate the equipment.

**IC: 4112104541A Gentex
MODEL/FCC ID: NZLSTDHL3**

STORAGE COMPARTMENT

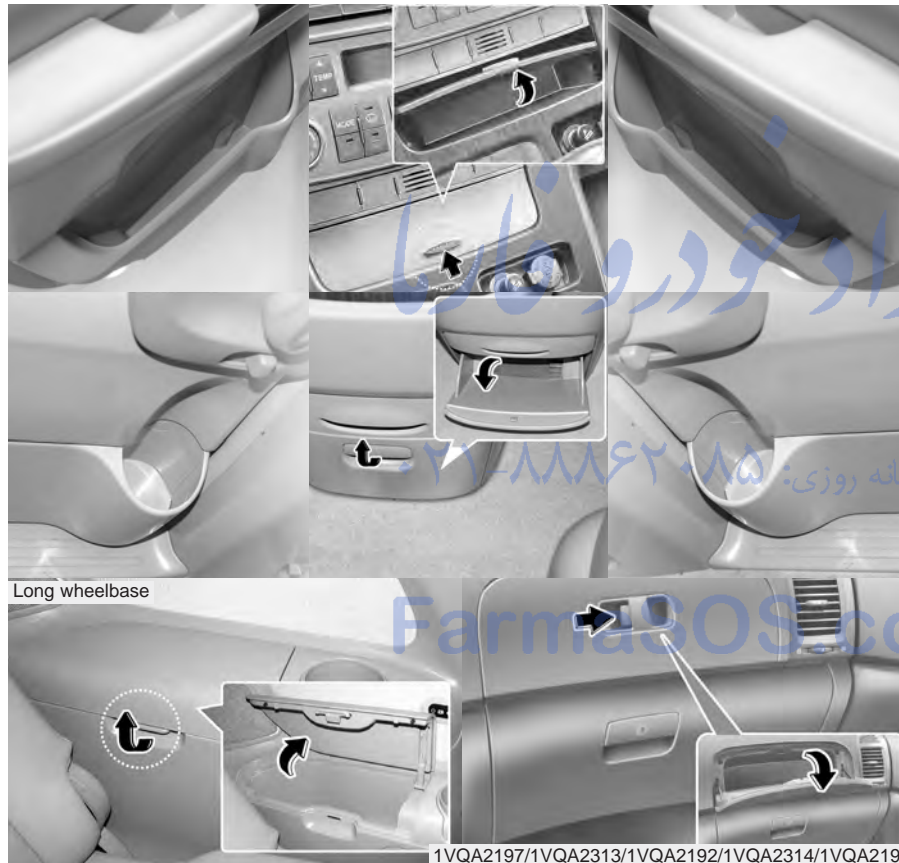

Long wheelbase

These compartments can be used to store small items required by the driver or passengers.

CAUTION

To avoid possible theft, do not leave valuables in the storage compartment.

WARNING

Always keep the storage compartment covers closed while driving. Do not attempt to place so many items in the storage compartment that the storage compartment cover can not close securely.

WARNING - Flammable materials

Do not store cigarette lighters, propane cylinders, or other flammable/explosive materials in the vehicle. These items may catch fire and/or explode if the vehicle is exposed to hot temperatures for extended periods.

Features of your vehicle



Center console storage (if equipped)

These compartments can be used to store small items required by the driver or front passenger.

Front

Cups or small beverage cans may be placed in the cup holders.

Center

The center compartment can be locked and unlocked with a master key.

To open the center compartment, make sure it is unlocked, then pull the lever and raise the cover.

To remove the bucket, lift it upward.



Rear

To open the rear compartment, pull the lever and the compartment will automatically open. Close the compartment after use.

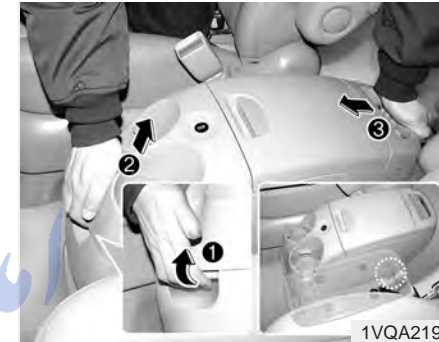

The center console storage can be removed and reinstalled.

To remove the storage, pull up the front portion slightly while pressing the release lever and move it forward.

To reinstall the storage, insert the rear tap on the bottom of the storage into the rear hole on the floor, put the front portion slightly on the floor while pressing the release lever and release the lever. Make sure the compartment is locked in place.

⚠ WARNING

Never leave the removed center storage console in the vehicle unsecured. The storage console can be thrown about in the vehicle in a sudden stop or an accident causing serious injuries or death to the vehicle occupants. Always make sure the storage console is locked in place.

⚠ CAUTION

Since key is not fully inserted into the center console storage key set, do not apply excessive force. Doing so may damage the parts.

⚠ WARNING

To reduce the risk of injury in an accident or sudden stop, always keep the center console storage cover closed while driving.

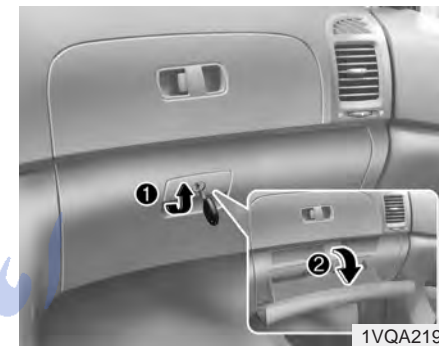

Glove box

The glove box can be locked and unlocked with a master key.

To open the glove box, make sure it is unlocked, then pull the handle (1) and the glove box will automatically open (2). Close the glove box after use.

شبهانه روزی: ۰۲۱-۸۸۶۲۰۸۵

FarmaSOS.com

Features of your vehicle

CAUTION

Since key is not fully inserted into the glove box key set, do not apply excessive force. Doing so may damage the parts.

WARNING

To reduce the risk of injury in an accident or sudden stop, always keep the glove box door closed while driving.



Sunglass holder

To open the sunglasses holder, press the cover and the holder will slowly open. Place your sunglasses in the compartment door with the lenses facing out. Push to close.

CAUTION

Make sure the sunglasses holder is closed while driving.

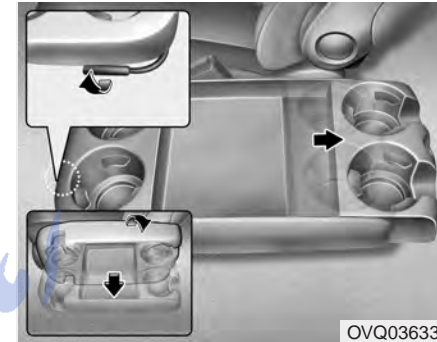

Side table (if equipped)

The side table is located on the inner portion of the passenger's seat.

To use the table, pull the table all the way up until it locks into place. Verify the table is locked by trying to push it down. If the table moves down, it is not locked properly.

You can extend it by pulling the rear portion backward.

To fold down the table, pull up the release lever and press down the edge of the table.

INTERIOR FEATURES



Cigarette lighter (if equipped)

To operate the cigarette lighter, press it in and release it. When it is heated, it automatically pops out ready for use.

If the engine is not running, the ignition switch must be in the ACC or ON position for the lighter to operate.

CAUTION

- Do not hold the lighter in after it is already heated because it will overheat.
- Only a genuine Kia lighter should be used in the cigarette lighter socket. The use of plug-in accessories (shavers, hand-held vacuums, and coffee pots, for example) may damage the socket or cause electrical failure.
- If the lighter does not pop out within 30 seconds, remove it to prevent overheating.

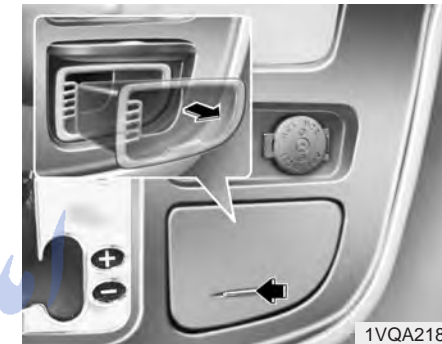

Ashtray (if equipped)

To use the ashtray, press the cover and release it.

To remove the ashtray to empty or clean it, lift it upward and pull it out.

WARNING - Ashtray use

- Do not use the vehicle's ashtrays as waste receptacles.
- Putting lit cigarettes or matches in an ashtray with other combustible materials may cause a fire.

Cup holder

⚠ WARNING - Hot liquids

- Do not place uncovered cups of hot liquid in the cup holder while the vehicle is in motion. If the hot liquid spills, you could be burned. Such a burn to the driver could cause a loss of control of the vehicle.
- To reduce the risk of personal injury in the event of sudden stop or collision, do not place uncovered or unsecured bottles, glasses, cans, etc., in the cup holder while the vehicle is in motion.

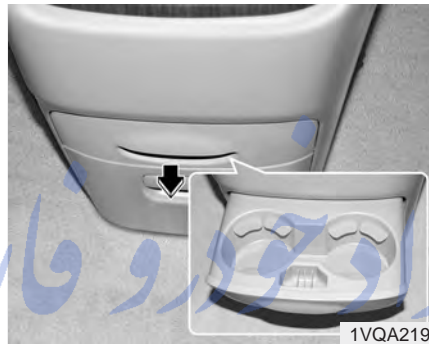

Front

To use the cup holders, pull the cup holder cover out. Push the cover to close after use.

⚠ CAUTION

Do not place heavy cups or cans in cup holders. Cup holders could be damaged.



Center (if equipped)

Cups or small beverage cans may be placed in the cup holders. The storage can be removed and reinstalled.

To remove the storage, pull up the rear portion slightly after moving the locking tap to the unlock position and move it rearward.

To reinstall the storage, insert the front tap on the bottom of the storage into the front hole on the floor, put the rear portion on the floor and move the locking tap to the lock position. Make sure the compartment is locked in place.

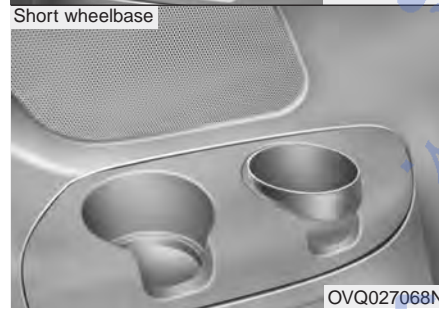

Rear
Cups or small beverage cans may be placed in the cup holders.



Shopping bag holder

Front

To use the holder, push the lower portion.

CAUTION

Do not hang a bag weighing more than 3 kg (7 lbs.). It may cause damage to the shopping bag holder.



Rear

*** NOTICE**

Do not hang heavy bags, since those may damage the holder.

Features of your vehicle

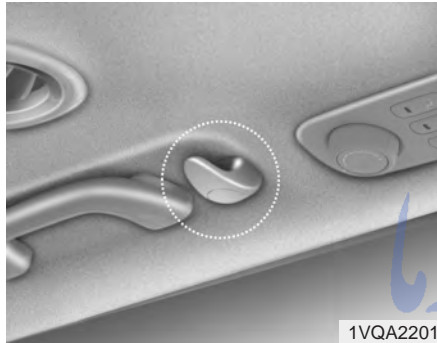

Clothes hanger

CAUTION

Do not hang heavy clothes, since those may damage the hook.



Sunvisor

Use the sunvisor to shield direct light through the front or side windows.

To use a sunvisor, pull it downward.

To use a sunvisor for a side window, pull it downward, unsnap it from the bracket (1) and swing it to the side (2).

Adjust the sunvisor forward or backward (3).

To use the vanity mirror, pull down the visor and pull up the mirror cover (4).

CAUTION - Vanity mirror (if equipped)

Close the vanity mirror cover securely and return the sunvisor to its original position after use. If the vanity mirror is not closed securely, the lamp will stay on and could result in battery discharge and possible sunvisor damage.

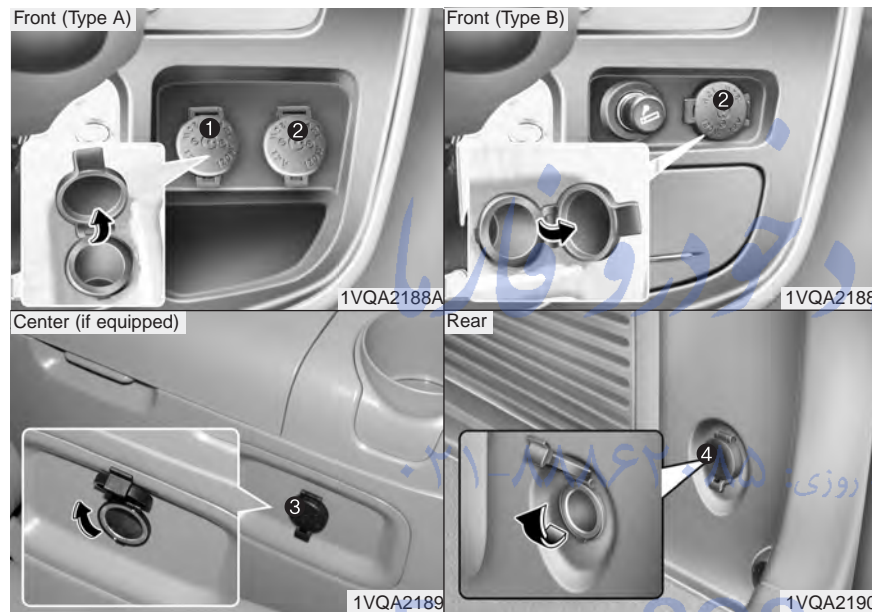

(1) : It can be used when the ignition switch is in ACC or ON position.
 (2), (3), (4) : It can be used regardless of the ignition switch position.

Power outlet

The power outlets are designed to provide power for mobile telephones or other devices designed to operate with vehicle electrical systems. The devices should draw less than 10 amps with the engine running.

CAUTION

- Use power outlet only when the engine is running and remove the accessory plug after use. Using the accessory plug for prolonged periods of time with the engine off could cause the battery to discharge.
- Only use 12V electric accessories which are less than 10A in electric capacity.
- Adjust the air-conditioner or heater to the lowest operating level when using the power outlet.
- Close the cover when not in use.
- Some electronic devices can cause electronic interference when plugged into a vehicle's power outlet. These devices may cause excessive audio static and malfunctions in other electronic systems or devices used in your vehicle.

Features of your vehicle



Digital clock

Whenever the battery terminals, related fuses are disconnected, you must reset the time.

When the ignition switch is in the ACC or ON position, the clock buttons operate as follows:

- **HOUR:**

Pressing the "H" button with your finger, a pencil or similar object will advance the time displayed by one hour.

- **MINUTE:**

Pressing the "M" button with your finger, a pencil or similar object will advance the time displayed by one minute.

- **RESET:**

To clear away minutes, press the "R" button with your finger, a pencil or similar object. Then the clock will be set precisely on the hour.

For example, if the "R" button is pressed while the time is between 9:01 and 9:29, the display will be reset to 9:00.

9:01 ~ 9:29 display changed to 9:00

9:30 ~ 9:59 display changed to 10:00

To change the 12 hour format to the 24 hour format, press the "R" button for more than 5 seconds.

For example, if the "R" button is pressed for more than 5 seconds while the time is 10:15 p.m., the display will be changed to 22:15.

ANTENNA



Roof antenna (If equipped)

If your vehicle has an audio system, an amplifying antenna is installed in your vehicle.

This antenna can be removed from the vehicle when you wash your vehicle.

* NOTICE

- Be sure to remove the antenna before washing the car in an automatic car wash or it may be damaged.
- When reinstalling your antenna, it is important that it is fully tightened to ensure proper reception.

AUDIO REMOTE CONTROL (IF EQUIPPED)



Glass antenna

When the radio power switch is turned on while the ignition key is in either the ON or ACC position, your car will receive both AM and FM broadcast signals through the antenna in the rear window glass or quarter glass.

CAUTION

- Do not clean the inside of the rear window glass or quarter glass with a cleaner or use a scraper to remove any foreign deposits as this may cause damage to the antenna elements.
- Avoid adding metallic coating such as Ni, Cd, and so on. These can interfere with AM/FM reception.

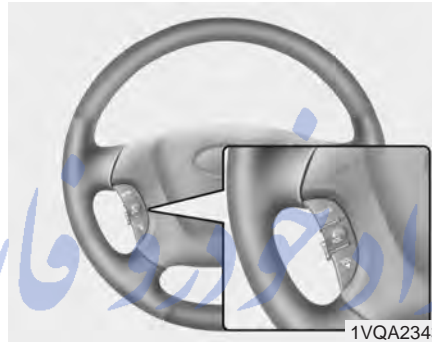

The steering wheel audio remote control button is installed to promote safe driving.

* NOTICE

Do not operate audio remote control buttons simultaneously.

MODE

Press the MODE button to select Radio, Tape (if equipped) or CD (compact disc). Each press of the button changes the display as follows:

MUTE

- Pull the MUTE button to deactivate the sound.
- Once again pull the MUTE button to reactivate the sound.

VOL (▲/▼)

- Press the VOL (▲) button to increase volume.
- Press the VOL (▼) button to decrease volume.

AUDIO SYSTEM

FM reception

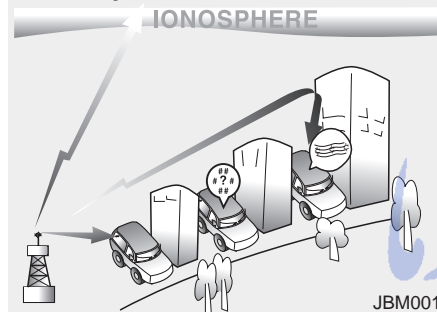

How car audio works

AM and FM radio signals are broadcast from transmitter towers located around your city. They are intercepted by the radio antenna on your car. This signal is then received by the radio and sent to your car speakers.

When a strong radio signal has reached your vehicle, the precise engineering of your audio system ensures the best possible quality reproduction. However, in some cases the signal coming to your vehicle may not be strong and clear. This can be due to factors such as the distance from the radio station, closeness of other strong radio stations or the presence of buildings, bridges or other large obstructions in the area.

AM reception

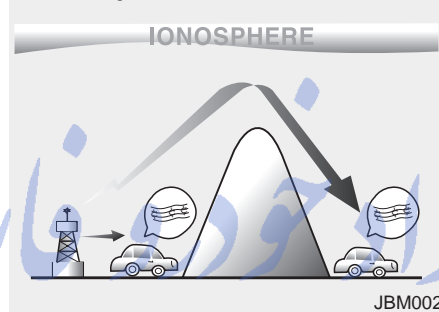

AM broadcasts can be received at greater distances than FM broadcasts. This is because AM radio waves are transmitted at low frequencies. These long, low frequency radio waves can follow the curvature of the earth rather than travelling straight out into the atmosphere. In addition, they curve around obstructions so that they can provide better signal coverage.

FM radio station

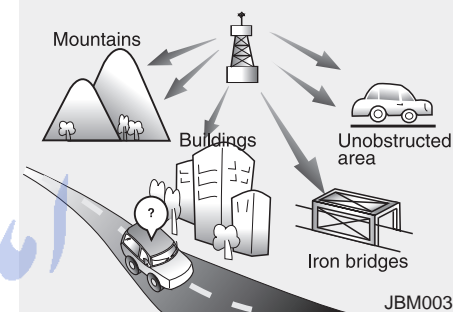

FM broadcasts are transmitted at high frequencies and do not bend to follow the earth's surface. Because of this, FM broadcasts generally begin to fade at short distances from the station. Also, FM signals are easily affected by buildings, mountains, or other obstructions. These can result in certain listening conditions which might lead you to believe a problem exists with your radio. The following conditions are normal and do not indicate radio trouble:

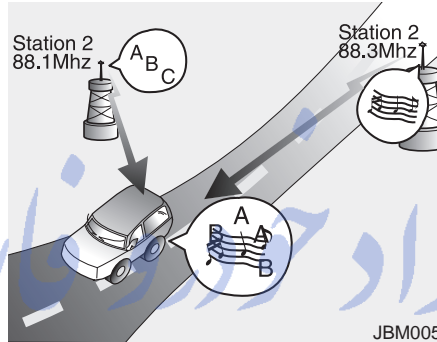
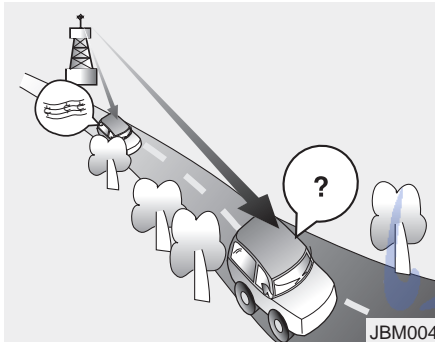

- Fading - As your car moves away from the radio station, the signal will weaken and sound will begin to fade. When this occurs, we suggest that you select another stronger station.
- Flutter/Static - Weak FM signals or large obstructions between the transmitter and your radio can disturb the signal causing static or fluttering noises to occur. Reducing the treble level may lessen this effect until the disturbance clears.

- Station Swapping - As a FM signal weakens, another more powerful signal near the same frequency may begin to play. This is because your radio is designed to lock onto the clearest signal. If this occurs, select another station with a stronger signal.
- Multi-Path Cancellation - Radio signals being received from several directions can cause distortion or fluttering. This can be caused by a direct and reflected signal from the same station, or by signals from two stations with close frequencies. If this occurs, select another station until the condition has passed.

Using a cellular phone or a two-way radio

When a cellular phone is used inside the vehicle, noise may be produced from the audio equipment. This does not mean that something is wrong with the audio equipment. In such a case, use the cellular phone at a place as far as possible from the audio equipment.

CAUTION

When using a communication system such a cellular phone or a radio set inside the vehicle, a separate external antenna must be fitted. When a cellular phone or a radio set is used with an internal antenna alone, it may interfere with the vehicle's electrical system and adversely affect safe operation of the vehicle.

WARNING

Don't use a cellular phone when you are driving. You must stop at a safe place to use a cellular phone.

Care of cassette tapes (if equipped)

- Because the thickness of a cassette tape with the total playback time of over 60 minutes (C-60) are too thin, we suggest that you do not use any of them to avoid having tapes being tangled.
- To achieve better sound quality, periodically clean the tape head using a cotton stick with colorless alcohol (once per month).
- If a tape is too loose, fasten it to reel by winding with objects like a pencil.
- Because dust or foreign objects on a cassette tape may damage the playback head, always store tapes in their cases when not in use.
- Make sure cassette tapes are kept away from magnetic devices (TV, stereo system, etc) in order to achieve better sound quality.
- Be certain that no objects or substances other than cassette tapes are inserted into the cassette tape player.
- Because tape media can be distorted when exposed to direct sunlight, Do not leave cassette tapes on the seats, dashboard or near the back windshield.

Care of disc (if equipped)

- If the temperature inside the car is too high, open the car windows for ventilation before using your car audio.
- It is illegal to copy and use MP3/WMA/AAC/WAVE files without permission (If equipped with M465, use only MP3/WMA, If equipped with M445, use only CD-DA). Use CDs that are created only by lawful means.
- Do not apply volatile agents such as benzene and thinner, normal cleaners and magnetic sprays made for analogue disc onto CDs.
- To prevent the disc surface from getting damaged. Hold and carry CDs by the edges or the edges of the center hole only.
- Clean the disc surface with a piece of soft cloth before playback (wipe it from the center to the outside edge).
- Do not damage the disc surface or attach pieces of sticky tape or paper onto it.
- Make sure on undesirable matter other than CDs are inserted into the CD player (Do not insert more than one CD at a time).
- Keep CDs in their cases after use to protect them from scratches or dirt.

- Depending on the type of CD-R/CD-RW CDs, certain CDs may not operate normally according to manufacturing companies or making and recording methods. In such circumstances, if you still continue to use those CDs, they may cause the malfunction of your car audio system.

* NOTICE - Playing an Incompatible Copy-Protected Audio CD

Some copy-protected CDs, which do not comply with the international audio CD standards (Red Book), may not play on your car audio. Please note that if you try to play copy protected CDs and the CD player of your car audio is not performing to your expectation, this may be caused by those CDs and not a defect in the device itself. Please replace those CDs.

STEREO RADIO OPERATION (M445) (IF EQUIPPED)



1. POWER ON-OFF, VOLUME Control Knob
2. BAND (AM/FM) Select Buttons
3. TUNE Select/AUDIO Control Knob
4. AUTO SEEK Select Button
5. CD SCAN Button
6. EQ Button
7. PRESET STATION Select Buttons

FarmaSOS.com

VQ445USA

1. POWER ON-OFF Control Knob

- The radio unit may be operated when the ignition key is in the "ACC" or "ON" position. Press the knob to switch the power on. The LCD shows the radio frequency in radio mode, and displays the CD track in CD mode. To switch the power off, press the knob again.
- Push the FM/AM or CD to turn on that function without pushing the Power ON-OFF control knob.

VOLUME Control

Rotate the knob clockwise to increase the volume and turn the knob counterclockwise to reduce the volume.

2. BAND Selector

FM Selection Button

Pressing the **FM** button changes the FM1 and FM2 bands.

AM(MW, LW) Selection Button

Pressing the **AM** button selects the AM band. AM mode is displayed on the LCD.

3. TUNE Select/AUDIO Control Knob

Rotate the knob clockwise to increase the frequency and turn the knob counterclockwise to reduce the frequency.

Mode Select

Pressing the MODE knob changes the BASS, MID-RANGE, TREBLE, FADER and BALANCE mode.

The mode selected is shown on the display.

After selecting each mode, rotate the knob clockwise or counterclockwise.

BASS Control

To increase the BASS, rotate the knob clockwise, while to decrease the BASS, rotate the knob counterclockwise.

MID-RANGE Control

To increase the MID-RANGE, rotate the knob clockwise, while to decrease the MID-RANGE, rotate the knob counterclockwise.

TREBLE Control

To increase the TREBLE, rotate the knob clockwise, while to decrease the TREBLE, rotate the knob counterclockwise.

FADER Control

Rotate the control knob clockwise to emphasize rear speaker sound (front speaker sound will be attenuated). When the control knob is turned counterclockwise, front speaker sound will be emphasized (rear speaker sound will be attenuated).

BALANCE Control

Rotate the knob clockwise to emphasize right speaker sound (left speaker sound will be attenuated). When the control knob is turned counterclockwise, left speaker sound will be emphasized (right speaker sound will be attenuated).

4. AUTO SEEK Select Button (Automatic Channel Selection)

Press the AUTO SEEK select button. When the \wedge side is pressed, the unit will automatically tune to the next higher frequency and when the \vee side is pressed, it will automatically tune to the next lower frequency.

5. CD SCAN Button

When you Press the button, frequency is changed and the next channel is received automatically.

To stay on a station, press the CD SCAN button again.

6. EQ Button

Press the EQ button to select the CLASSIC, POPS, ROCK, JAZZ and OFF MODE for the desired tone quality. Each press of the button changes the display as follows;

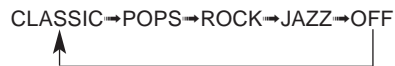

7. PRESET STATION Select Buttons

Six stations for AM, FM1 and FM2 respectively can be preset in the electronic memory circuit.

HOW TO PRESET STATIONS

Six AM and twelve FM stations may be programmed into the memory of the radio. Then, by simply pressing the AM/FM band select buttons and/or one of the six station select buttons, you may recall any of these stations instantly.

To program the stations, follow these steps:

- Press AM/FM selector to set the band for AM, FM1 and FM2.
- Select the desired station to be stored by seek or manual tuning.
- Determine the preset station select button you wish to use to access that station.
- Press and hold the station select button for more than 0.8 seconds. A select button indicator will show in the display indicating which select button you have depressed. The frequency display will flash after it has been stored into the memory. You should then release the button, and proceed to program the next desired station. A total of 18 stations can be programmed by selecting one AM and two FM stations per button.
- When completed, any preset station may be recalled by selecting AM, FM1 or FM2 band and the appropriate station button.

CAUTION

- *Do not place beverages close to the audio system. The audio system mechanism may be damaged if you spill them.*
- *Do not strike or allow anything to impact the audio system, damage to the system mechanisms could occur.*

COMPACT DISC PLAYER OPERATION (M445) (IF EQUIPPED)

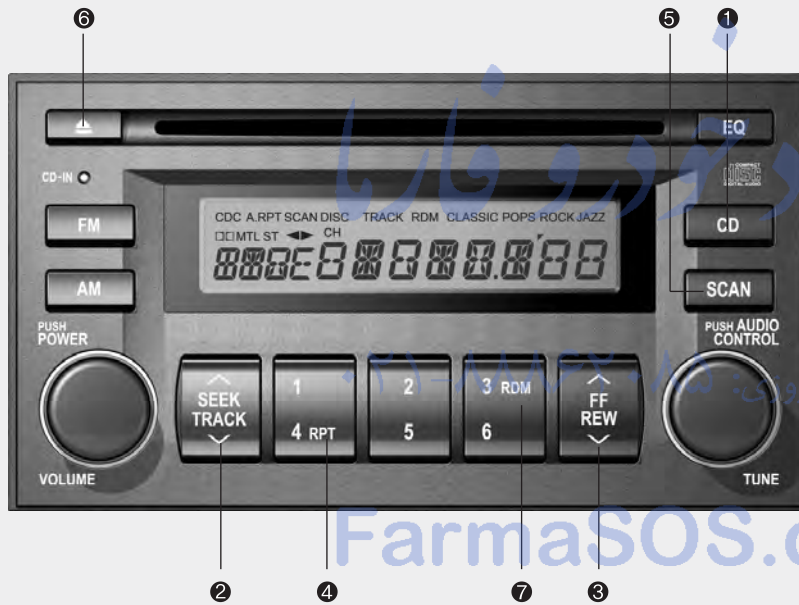

1. CD Select Button
2. TRACK UP/DOWN Button
3. FF/REW Button
4. REPEAT (RPT) Button
5. CD SCAN (BSM) Button
6. CD EJECT Button
7. RANDOM (RDM) Button

FarmaSOS.com

VQ445USA

1. CD Select Button

- Insert the CD with the label facing upward.
- Insert the CD to start CD playback, during radio operation.
- When a disc is in the CD deck, if you press the CD button the CD player will begin playing even if the radio player is being used.
- The CD player can be used when the ignition switch is in either the "ON" or "ACC" position.
- Push the CD button to turn on that function without pushing the Power ON-OFF control knob.

* NOTICE

- Do not stick paper or tape etc., on the label side or the recording side of any discs, as it may cause a malfunction.
- The unit cannot play a CD-R(Recordable CD) and CD-RW(Rewritable CD) that is not finalized. Please refer to the manual of CD-R/CD-RW recoder or CD-R/CD-RW software for more information on finalization process.
- Depending on the recording status, some CD-Rs/CD-RWs may not be played on this unit.

2. TRACK UP/DOWN Button

- The desired track on the disc currently being played can be selected using the track number.
- Press \wedge button once to skip forward to the beginning of the next track. Press \vee within a second after playback begins to quickly move backward through a CD. If you press \vee after more than a second, it will take you to the beginning of the track you are now listening to.

3. FF/REW Button

If you want to fast forward or reverse through the compact disc track, push and hold the FF or REW button. When you release the button, the compact disc player will resume playing.

4. REPEAT (RPT) Button

- To repeat the track you are currently listening to, press the RPT button. To cancel, press it again.
- If you do not release RPT operation when the track ends, it will automatically be replayed. This process will be continued until you push the button again or turn the Power OFF then ON.

5. CD SCAN Button

- To playback the first 10 seconds of each track, press the CD SCAN button.
- Press the CD SCAN button again within 10 sec. when you have reached the desired track.

6. CD EJECT Button

When the \square button is pressed with a CD loaded, the CD will eject.

Forcing to eject : To force to eject a CD, press this button for more than 3 seconds.

(Do this only when a CD is jammed and you can not eject it in the normal way - e.g.) in case that you have inserted 2 CDs by mistake)

7. RANDOM (RDM) Button

With random, you can listen to the tracks in random, rather than sequential order.

To use random, do the following: Press the RDM button to listen to recorded tracks in random sequence. Press RDM again to cancel or turn the power OFF then ON. The unit defaults to playing tracks in sequential order.

*** NOTICE**

- To assure proper operation of the unit, keep the vehicle interior temperature within a normal range by using the vehicle's air conditioning or heating system.
- When replacing the fuse, replace it with a fuse having the correct capacity.
- All stored bookmarks are all erased when the car battery is disconnected or power to the vehicle is lost. If this occurs, the bookmarks will have to be reset.
- This equipment is designed to be used only in a 12 volt DC battery system with negative ground.
- This unit is made of precision parts. Do not attempt to disassemble or adjust any parts.
- Do not expose this equipment (including the speakers and CD) to water or excessive moisture.

CAUTION

- *Do not insert warped or poor quality discs into the CD player as damage to the unit may occur.*
- *Do not insert anything like coins into the player slot as damage to the unit may occur.*
- *Do not place beverages close to the audio system. The playback mechanism may be damaged if you spill them.*
- *Do not strike or allow anything to impact the audio system, damage to the system mechanisms could occur.*
- *Off-road or rough surface driving may cause the compact disc to skip. Do not use the compact disc when driving in such conditions as damage to the compact disc face could occur.*

(Continued)

(Continued)

- *Do not attempt to grab or pull the compact disc out while the disc is being pulled into the audio unit by the self-loading mechanism. Damage to the audio unit and compact disc could occur.*
- *Avoid using recorded compact discs in your audio unit. Original compact discs are recommended for best results.*

WARNING

When driving your vehicle, be sure to keep the volume of the unit set low enough to allow you to hear sounds coming from the outside.

STEREO RADIO OPERATION (M455) (IF EQUIPPED)

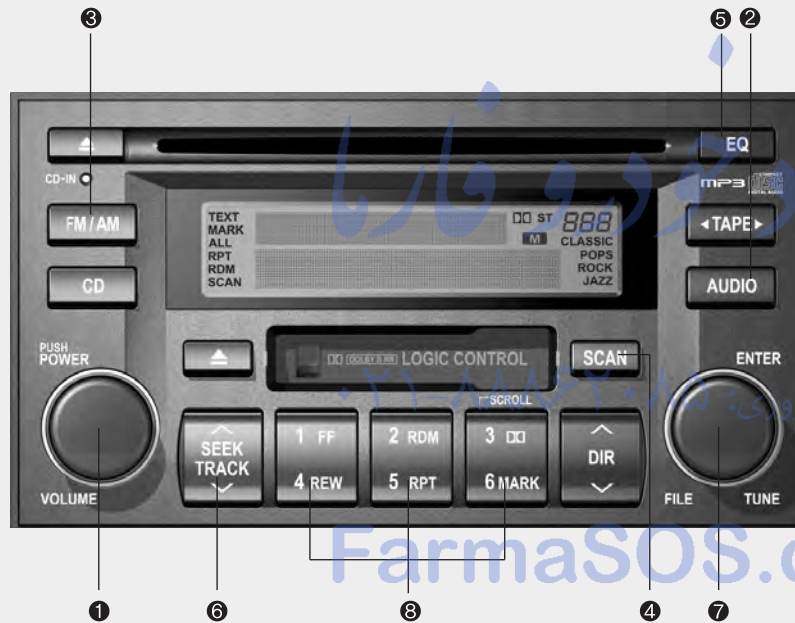

1. POWER ON-OFF, VOLUME Control Knob
2. AUDIO Select Button
3. BAND Select Button
4. CD SCAN Button
5. EQ Button
6. AUTO SEEK Select Button
7. TUNE Select/AUDIO Control knob
8. PRESET STATION Select Buttons

VQ455USA

1. POWER ON-OFF Control Knob

- The radio unit may be operated when the ignition key is in the "ACC" or "ON" position. Press the button to switch the power on. The LCD shows the radio frequency in the radio mode, the tape direction indicator in the tape mode or CD/MP3 track in the CD/MP3 mode. To switch the power off, press the button again.
- Push the FM/AM, TAPE or CD/MP3 to turn on that function without pushing the Power ON-OFF control knob.

VOLUME Control

Rotate the knob clockwise to increase the volume and turn the knob counterclockwise to reduce the volume.

2. AUDIO Select Button

Pressing the AUDIO button changes the BASS, MID-RANGE, TREBLE, FADER and BALANCE mode.

The mode selected is shown on the display.

After selecting each mode, rotate the Audio control knob clockwise or counterclockwise.

BASS Control

To increase the BASS, rotate the knob clockwise, while to decrease the BASS, rotate the knob counterclockwise.

MID-RANGE Control

To increase the MID-RANGE, rotate the knob clockwise, while to decrease the MID-RANGE, rotate the knob counterclockwise.

TREBLE Control

To increase the TREBLE, rotate the knob clockwise, while to decrease the TREBLE, rotate the knob counterclockwise.

FADER Control

Turn the control knob clockwise to emphasize rear speaker sound (front speaker sound will be attenuated). When the control knob is turned counterclockwise, front speaker sound will be emphasized (rear speaker sound will be attenuated).

BALANCE Control

Rotate the knob clockwise to emphasize right speaker sound (left speaker sound will be attenuated). When the control knob is turned counter clockwise, left speaker sound will be emphasized (right speaker sound will be attenuated).

3. BAND Select Button

Pressing the FM/AM button changes the AM, FM1 and FM2 bands. The mode selected is shown on the display.

4. CD SCAN Button

When you press the button, frequency is changed and the next channel is received automatically.

To stay on a station, press the CD SCAN button again.

5. EQ Button

Press the EQ button to select the CLASSIC, POPS, ROCK, JAZZ and OFF MODE for the desired tone quality. Each press of the button changes the display as follows;

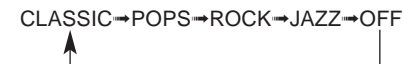

6. AUTO SEEK Select Button (Automatic Channel Selection)

Press the AUTO SEEK select button. When the \wedge side is pressed, the unit will automatically tune to the next higher frequency and when the \vee side is pressed, it will automatically tune to the next lower frequency.

7. TUNE Select/Audio Control Knob

Rotate the knob clockwise to increase the frequency and turn the knob counter-clockwise to reduce the frequency.

8. PRESET STATION Select Buttons

Six stations for AM, FM1 and FM2 respectively can be preset in the electronic memory circuit.

HOW TO PRESET STATIONS

Six AM and twelve FM stations may be programmed into the memory of the radio. Then, by simply pressing the AM/FM band select button and/or one of the six station select buttons, you may recall any of these stations instantly. To program the stations, follow these steps:

- Press AM/FM selector to set the band for AM, FM1 and FM2.
- Select the desired station to be stored by seek or manual tuning.
- Determine the preset station select button you wish to use to access that station.

- Press and hold the station select button for more than 0.8 seconds. A select button indicator will show in the display indicating which select button you have depressed. The frequency display will flash after it has been stored in to the memory. You should then release the button, and proceed to program the next desired station. A total of 18 stations can be programmed by selecting one AM and two FM stations per button.
- When completed, any preset station may be recalled by selecting AM, FM1 or FM2 band and the appropriate station button.

CAUTION

- **Do not place beverages close to the audio system. The playback mechanism may be damaged if you spill them.**
- **Do not strike or allow anything to impact the audio system, damage to the system mechanisms could occur.**

CASSETTE TAPE PLAYER OPERATION (M455) (IF EQUIPPED)

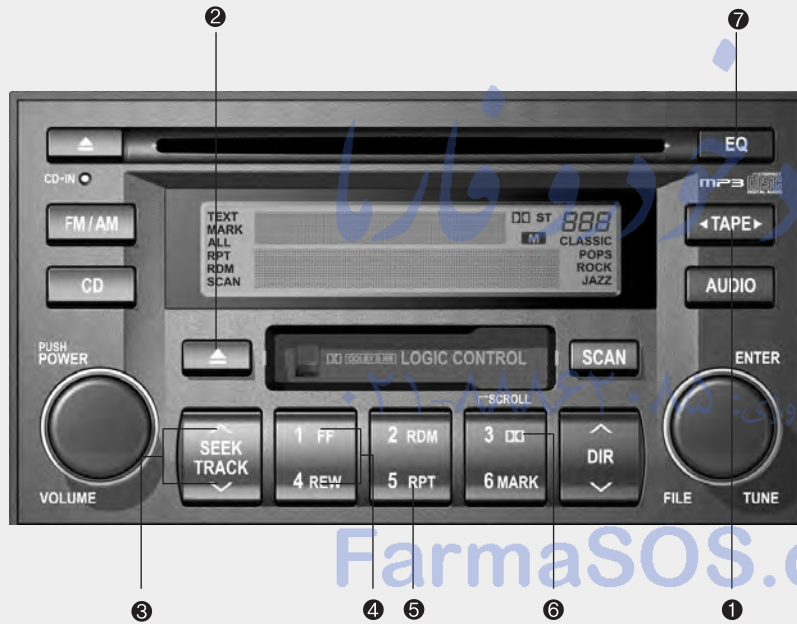

1. TAPE PROGRAM Button
2. TAPE EJECT Button
3. AUTO MUSIC SEARCH (AMS) Button
4. FF/REW Button
5. REPEAT (RPT) Button
6. DOLBY Button
7. EQ Button



FarmaSOS.com

VQ455USA

1. TAPE PROGRAM Button



- This allows you to play the reverse side of the tape by merely depressing the program button. An arrow will appear in the display to show tape direction.
- Push the TAPE button while the tape is in the tape deck, to turn on that function without pushing the Power ON-OFF control knob.

2. TAPE EJECT Button

- When the  button is pressed with a cassette loaded, the cassette will eject.
- When the  button is pressed during FF/REW mode, the cassette will eject.

3. AUTO MUSIC SEARCH (AMS) Button

Press the button to find the starting point of each song in a prerecorded music tape. The quiet space between songs (must have at least 4 sec. gap) can be identified by the AUTO MUSIC SEARCH button.

- Pressing the  button will play the beginning of the next music segment.
- Pressing the  button will start replay at the beginning of the music just listened to.

- To stop FF or REW action, press the button again.

4. FF/REW Button

- Forward tape winding starts when the FF button is pressed during PLAY or REW mode.
- Tape PLAY starts when the FF button is pressed again during FF mode.
- Tape rewinding starts when the REW button is pressed during PLAY or FF mode.
- Tape PLAY starts when the REW button pressed again during REW mode.

5. REPEAT (RPT) Button

- To repeat the track you are currently listening to, press the RPT button. To cancel, press again.
- If you do not release RPT operation when the track ends, it will automatically be replayed. This process will be continued until you push the button again or turn the power OFF then ON.

6. DOLBY Button

If you get background noise during tape PLAY, you can reduce this considerably by merely pressing the DOLBY button. If you want to cancel the DOLBY feature, press the button again.

7. EQ Button

Press the EQ button to select the CLASSIC, POPS, ROCK, JAZZ and OFF MODE for the desired tone quality. Each press of the button changes the display as follows;



Features of your vehicle

* NOTICE

- To assure proper operation of the unit, keep the vehicle interior temperature within a normal range by using the vehicle's air conditioning or heating system.
- When replacing the fuse, replace it with a fuse having the correct capacity.
- The preset station frequencies are all erased when the car battery is disconnected. Therefore, all data will have to be set again if this should occur.
- Do not add any oil to the rotating parts. Keep magnets, screwdrivers and other metallic objects away from the tape mechanism and head.
- This equipment is designed to be used only in a 12 volt DC battery system with negative ground.
- This unit is made of precision parts. Do not attempt to disassemble or adjust any parts.

(Continued)

(Continued)

- Do not expose this equipment (including the speakers and tape) to water or excessive moisture.

CAUTION

- *Do not insert anything like coins into the player slot as damage to the unit may occur.*
- *Do not place beverages close to the audio system. The playback mechanism may be damaged if you spill them.*
- *Do not strike or allow anything to impact the audio system, damage to the system mechanisms could occur.*

WARNING

When driving your vehicle, be sure to keep the volume of the unit set low enough to allow you to hear sounds coming from the outside.

COMPACT DISC PLAYER (M455) (IF EQUIPPED) - Compatible with MP3/WMA/AAC/WAVE



1. AUDIO/MP3 CD Select Button
2. TRACK UP/DOWN Button
3. FF/REW Button
4. REPEAT (RPT) Button
5. RANDOM (RDM) Button
6. BOOKMARK (MARK) Button
7. SCROLL Button
8. EQ Button
9. CD EJECT Button
10. CD SCAN Button
11. FILE SEARCH Knob
(TUNE Select Knob)
12. DIRECTORY SEARCH (DIR) Button

FarmaSOS.com

VQ455USA

1. AUDIO/MP3 CD Select Button

- Insert the CD with the label facing upward.
- Insert the CD to start CD playback, during radio operation or cassette tape playback.
- If you press the CD button while a disc is in the CD deck, the CD player will begin playing even if the radio or cassette player is being used.
- The CD player can be used when the ignition switch is in either the "ON" or "ACC" position.
- Push the CD button to turn on that function without pushing the Power ON-OFF control knob.

* NOTICE

- Do not stick paper or tape etc., on the label side or the recording side of any discs, as it may cause a malfunction.
- The unit can play a multi-session CD-R (recordable CD) and CD-RW (rewritable CD) that consists of more than two sessions.
Please refer to the manual of CD-R/CD-RW recoder or CD-R/CD-RW software for more information on finalization process.
- Depending on the recording status, some CD-Rs/CD-RWs may not be played on this unit.

* NOTICE

Playback of MP3, AAC and WMA file formats are supported. Load to play time for these formats may be longer due to the compressed nature of these discs.

2. TRACK UP/DOWN Button

- The desired track on the disc currently being played can be selected using the track number.
- Press \wedge button once to skip forward to the beginning of the next track.
Press \vee within a second after playback begins to quickly move backward through a CD.
—If you press \vee after more than a second, it will take you to the beginning of the file you are now listening to.

3. FF/REW Button

If you want to fast forward or reverse through the compact disc track, push and hold the FF or REW button. When you release the button, the compact disc player will resume playing.

4. REPEAT (RPT) Button

- To repeat the track you are currently listening to, press the RPT button. To cancel, press it again.
- To repeat the music within selected folder, press the RPT button for more than 0.8 seconds. To cancel, press it again. (MP3 CD only)
- If you do not release RPT operation when the track ends, it will automatically be replayed.
This process will be continued until you push the button again or turn the power OFF then ON.

5. RANDOM (RDM) Button

With random, you can listen to the tracks in random, rather than sequential order. To use random, do the following:

- Press the RDM button to listen to recorded tracks in random sequence. Press RDM again to cancel or turn the power OFF then ON. The unit defaults to playing tracks in sequential order.
- To listen to the music within the selected folder in random order, press the RDM button within a second. To cancel, press it again or turn the power OFF then ON. (MP3 CD only)

6. BOOKMARK (MARK) Button

When the CD player unit is operating, the desired track on the disc can be bookmarked by using the MARK button.(MP3 CD only)

- Press the MARK button for more than 0.8 seconds to bookmark the desired track.

“M” will be displayed on the LCD and “MEMORY(1~50)” will display for approximately five seconds with beep sound.

To play a bookmarked track, press the MARK button within 0.8 seconds and select the bookmarked track to play.

- To erase a bookmarked track, press the MARK button for more than 0.8 seconds. The unit will beep once when the bookmark is erased.

* NOTICE

Tracks stored on Mark Memory will be automatically erased after you eject CDs that contain those tracks.

7. SCROLL Button

Press the button, and you can check the file names with more than 16 characters on MP3 CD(max 34 characters.).

The button doesn't work on file names less than 16 characters.

8. EQ Button

Press the EQ button to select the CLASSIC, POPS, ROCK, JAZZ and OFF MODE for the desired tone quality. Each press of the button changes the display as follows;

CLASSIC → POPS → ROCK → JAZZ → OFF

9. CD EJECT Button

When the button is pressed with a CD loaded, the CD will eject.

Forcing to eject : To force to eject a CD, press this button for more than 3 seconds.

(Do this only when a CD is jammed and you can not eject it in the normal way - e.g.) in case that you have inserted 2 CDs by mistake)

10. CD SCAN Button

- To playback the first 10 seconds of each track, press the CD SCAN button more than 0.8 seconds.
- To playback the first 10 seconds of each track in the selected folder, press the CD SCAN button within 0.8 seconds. (MP3 CD only)

- Press the CD SCAN button again within 10 sec. when you have reached the desired track.

11. FILE SEARCH Knob (TUNE Select Knob)

- You can skip the track (file) by turning the FILE SEARCH knob clockwise or counterclockwise.

After selecting the desired track (file), press the FILE SEARCH knob to playback the track (file).

If you do not press the FILE SEARCH knob within five seconds, the search will stop.

12. DIRECTORY SEARCH (DIR) Button

- You can move through the folder by pushing the DIR button to up () and down().
- After moving the desired folder, press the FILE SEARCH knob to play back in the selected folder. If you do not press the FILE SEARCH knob within 5 seconds, the folder searching function will be released. It can not be operated in a single folder.

*** NOTICE**

- To assure proper operation of the unit, keep the vehicle interior temperature within a normal range by using the vehicle's air conditioning or heating system.
- When replacing the fuse, replace it with a fuse having the correct capacity.
- All stored bookmarks are all erased when the car battery is disconnected or power to the vehicle is lost. If this occurs, the bookmarks will have to be reset.
- This equipment is designed to be used only in a 12 volt DC battery system with negative ground.
- This unit is made of precision parts. Do not attempt to disassemble or adjust any parts.
- Do not expose this equipment (including the speakers and tape) to water or excessive moisture.

⚠ CAUTION

- *Do not insert warped or poor quality discs into the CD player as damage to the unit may occur.*
- *Do not insert anything like coins into the player slot as damage to the unit may occur.*
- *Do not place beverages close to the audio system. The playback mechanism may be damaged if you spill them.*
- *Do not strike or allow anything to impact the audio system, damage to the system mechanisms could occur.*
- *Off-road or rough surface driving may cause the compact disc to skip. Do not use the compact disc when driving in such conditions as damage to the compact disc face could occur.*

(Continued)

(Continued)

- *Do not attempt to grab or pull the compact disc out while the disc is being pulled into the audio unit by the self-loading mechanism. Damage to the audio unit and compact disc could occur.*
- *Avoid using recorded compact discs in your audio unit. Original compact discs are recommended for best results.*

⚠ WARNING

When driving your vehicle, be sure to keep the volume of the unit set low enough to allow you to hear sounds coming from the outside.

STEREO RADIO OPERATION (M465) (IF EQUIPPED)



1. POWER ON-OFF, VOLUME Control Knob
2. BAND Select Button
3. AUDIO Select Button
4. TUNE Select/AUDIO Control Knob
5. AUTO SEEK Select Button
6. CD SCAN Button
7. EQ Button or AUX Button
8. PRESET Station Select Buttons

FarmaSOS.com

VQ465USA

1. POWER ON-OFF Control Knob

- The radio unit may be operated when the ignition key is in the "ACC" or "ON" position. Press the knob to switch the power on. The LCD shows the radio frequency in the radio mode, the tape direction indicator in the tape mode or CD/MP3 track in the CD/MP3 mode or CD AUTO CHANGER mode. To switch the power off, press the knob again.
- Push the FM/AM, TAPE or CD/MP3 to turn on that function without pushing the Power ON-OFF control knob.

VOLUME Control

Rotate the knob clockwise to increase the volume and turn the knob counterclockwise to reduce the volume.

2. BAND Select Button

Pressing the FM/AM button changes the AM, FM1 and FM2 bands. The mode selected is shown on the display.

3. AUDIO Select Button

Pressing the AUDIO button changes the BASS, MID-RANGE, TREBLE, FADER, BALANCE and SURROUND mode. The mode selected is shown on the display.

After selecting the each mode, rotate the Audio control knob clockwise or counterclockwise.

BASS Control

To increase the BASS, rotate the knob clockwise, while to decrease the BASS, rotate the knob counterclockwise.

MID-RANGE Control

To increase the MID-RANGE, rotate the knob clockwise, while to decrease the MID-RANGE, rotate the knob counterclockwise.

TREBLE Control

To increase the TREBLE, rotate the knob clockwise, while to decrease the TREBLE, rotate the knob counterclockwise.

FADER Control

Rotate the control knob clockwise to emphasize rear speaker sound (front speaker sound will be attenuated). When the control knob is turned counterclockwise, front speaker sound will be emphasized (rear speaker sound will be attenuated).

BALANCE Control

Rotate the knob clockwise to emphasize right speaker sound (left speaker sound will be attenuated). When the control knob is turned counterclockwise, left speaker sound will be emphasized (right speaker sound will be attenuated).

SURROUND Control (if equipped with RSE)

To turn on the SURROUND, rotate the knob clockwise, while to turn off the SURROUND, rotate the knob counterclockwise. The surround sound is not consistent when cycling from radio to CD, cassette or DVD. Therefore, the SURROUND ON/OFF control should be selected, whenever you change to other audio modes (AM/FM, CASSETTE TAPE, CD, AUX).

4. TUNE Select/AUDIO Control Knob

Rotate the knob clockwise to increase the frequency and turn the knob counterclockwise to reduce the frequency.

5. AUTO SEEK Select Button (Automatic Channel Selection)

Press the AUTO SEEK select button. When the \wedge side is pressed, the unit will automatically tune to the next higher frequency and when the \vee side is pressed, it will automatically tune to the next lower frequency.

6. CD SCAN Button

When you press the button, frequency is changed and the next channel is received automatically.

To stay on a station, press the CD SCAN button again.

7. EQ Button or AUX Button

Press the EQ button to select the CLASSIC, POPS, ROCK, JAZZ and OFF MODE for the desired tone quality. Each press of the button changes the display as follows;



- If the button is written AUX, it will change to AUX mode when you press the button, and the button has no EQ function.
- The AUX button is functional only if RSE unit is on.
- You can enjoy the RSE audio through the speakers in AUX mode.
- The speaker volume level is adjustable by VOLUME(+,-) key, on RSE unit or wireless remote control.
- Refer to the "RSE" in this section for details RSE operation.

- RSE : Rear Seat Entertainment System(A/V).

8. PRESET STATION Select Buttons

Six stations for AM, FM1 and FM2 respectively can be preset in the electronic memory circuit.

HOW TO PRESET STATIONS

Six AM and twelve FM stations may be programmed into the memory of the radio. Then, by simply pressing the AM/FM band select button and/or one of the six station select buttons, you may recall any of these stations instantly. To program the stations, follow these steps:

- Press AM/FM selector to set the band for AM, FM1 and FM2.
- Select the desired station to be stored by seek or manual tuning.
- Determine the preset station select button you wish to use to access that station.

- Press and hold the station select button for more than 0.8 seconds. A select button indicator will show in the display indicating which select button you have depressed. The frequency display will flash after it has been stored into the memory. You should then release the button, and proceed to program the next desired station. A total of 18 stations can be programmed by selecting one AM and two FM stations per button.
- When completed, any preset station may be recalled by selecting AM, FM1 or FM2 band and the appropriate station button.

CAUTION

- *Do not place beverages close to the audio system. The audio system mechanism may be damaged if you spill them.*
- *Do not strike or allow anything to impact the audio system, damage to the system mechanisms could occur.*

CASSETTE TAPE PLAYER OPERATION (M465) (IF EQUIPPED)



1. TAP PROGRAM Button
2. TAP EJECT Button
3. AUTO MUSIC SEARCH (AMS) Button
4. FF/REW Button
5. REPEAT (RPT) Button
6. DOLBY Button
7. EQ Button or AUX Button



FarmaSOS.com

VQ465USA

1. TAPE PROGRAM Button



- This allows you to play the reverse side of the tape by merely depressing the program button. An arrow will appear in the display to show tape direction.
- Push the TAPE button while the tape is in the tape deck, to turn on that function without pushing the Power ON-OFF control knob.

2. TAPE EJECT Button

- When the  button is pressed with a cassette loaded, the cassette will eject.
- When the  button is pressed during FF/REW mode, the cassette will eject.

3. AUTO MUSIC SEARCH (AMS) Button

Press the button to find the starting point of each song in a prerecorded music tape. The quiet space between songs (must have at least 4 sec. gap) can be identified by the AUTO MUSIC SEARCH button.

- Pressing the  button will play the beginning of the next music segment.
- Pressing the  button will start replay at the beginning of the music just listened to.
- To stop FF or REW action, press the button again.

4. FF/REW Button

- Forward tape winding starts when the FF button is pressed during PLAY or REW mode.
- Tape PLAY starts when the FF button is pressed again during FF mode.
- Tape rewinding starts when the REW button is pressed during PLAY or FF mode.
- Tape PLAY starts when the REW button is pressed again during REW mode.

5. REPEAT (RPT) Button

- To repeat the track you are currently listening to, press the RPT button. To cancel, press again.
- If you do not release RPT operation when the track ends, it will automatically be replayed. This process will be continued until you push the button again or turn the power OFF then ON.

6. DOLBY Button

If you get background noise during tape PLAY, you can reduce this considerably by merely pressing the DOLBY button. If you want to cancel the DOLBY feature, press the button again.

7. EQ Button or AUX Button

Press the EQ button to select the CLASSIC, POPS, ROCK, JAZZ and OFF MODE for the desired tone quality. Each press of the button changes the display as follows;

CLASSIC → POPS → ROCK → JAZZ → OFF

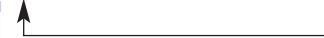

- If the button is labeled AUX, it will change to AUX mode when you press the button, and the button has no EQ function.
- The AUX button is functional only if RSE unit is on.
- You can enjoy the RSE audio through the speakers in AUX mode.
- The speaker volume level is adjustable by VOLUME(+,-) key, on RSE unit or wireless remote control.
- * Refer to the "RSE" in this section for details RSE operation.
- * RSE : Rear Seat Entertainment System(A/V).

Features of your vehicle

* NOTICE

- To assure proper operation of the unit, keep the vehicle interior temperature within a normal range by using the vehicle's air conditioning or heating system.
- When replacing the fuse, replace it with a fuse having the correct capacity.
- The preset station frequencies are all erased when the car battery is disconnected. Therefore, all data will have to be set again if this should occur.
- Do not add any oil to the rotating parts. Keep magnets, screwdrivers and other metallic objects away from the tape mechanism and head.
- This equipment is designed to be used only in a 12 volt DC battery system with negative ground.
- This unit is made of precision parts. Do not attempt to disassemble or adjust any parts.

(Continued)

(Continued)

- Do not expose this equipment (including the speakers and tape) to water or excessive moisture.

CAUTION

- *Do not insert anything like coins into the player slot as damage to the unit may occur.*
- *Do not place beverages close to the audio system. The playback mechanism may be damaged if you spill them.*
- *Do not strike or allow anything to impact the audio system, damage to the system mechanisms could occur.*

WARNING

When driving your vehicle, be sure to keep the volume of the unit set low enough to allow you to hear sounds coming from the outside.

COMPACT DISC PLAYER/CD AUTO CHANGER OPERATION (M465) (IF EQUIPPED)

- Compatiable with MP3/WMA

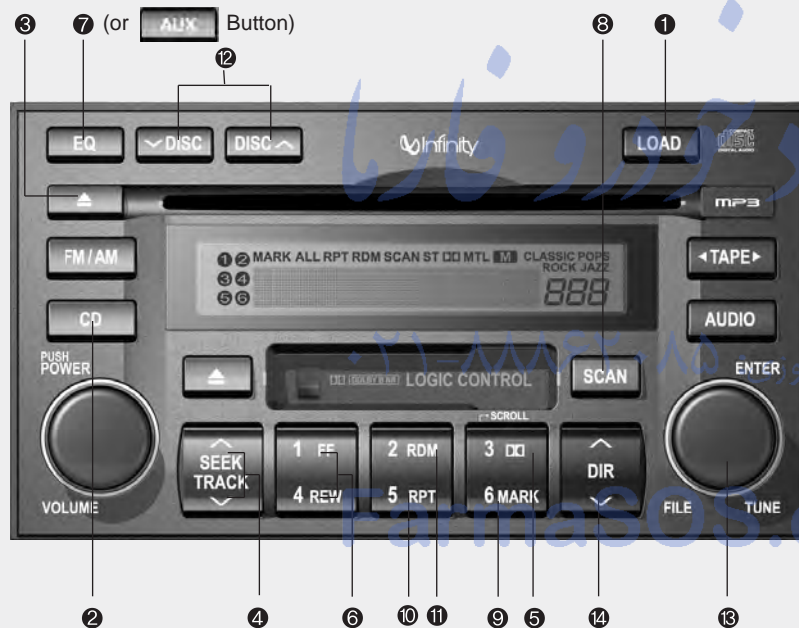

1. LOAD Button
2. Playing CD Button
3. CD EJECT Button
4. TRACK UP/DOWN Button
5. SCROLL Button
6. FF/REW Button
7. EQ Button or AUX Button
8. CD SCAN Button
9. BOOKMARK (MARK) Button
10. REPEAT (RPT) Button
11. RANDOM (RDM) Button
12. DISC UP/DOWN Button
13. FILE SEARCH Knob (TUNE Select Knob)
14. DIRECTORY SEARCH (DIR) Button

VQ465USA

1. LOAD Button

This compact disc player will accommodate up to six compact discs.

To insert multiple discs into the player, perform the following:

1. Press and release the LOAD Button.
2. Green light on the slot will be illuminated and the lowest number of empty slot will blink on the display.
After "WAIT" is displayed on the LCD, the slot will open with "INSERT" displayed on the LCD.
3. Insert a disc partway into the slot, label side up. The player will pull the disc in.

When the disc is inserted, the disc will begin to play automatically.

* NOTICE

- The disc can be only inserted while the green light is blinking on the slot.
- This CD player is suitable only for 12 cm discs, do not use irregular shaped CDs.

To insert multiple discs do the followings:

1. Press and hold the LOAD button for one second or more.
You will then hear a beep sound and the green light on the slot will be illuminated, and the numbers of empty disc will blink on the display.

2. After "WAIT" is displayed on the LCD with the lowest number of empty slot blinking, the slot will open with "INSERT" displayed on the LCD.

3. Insert a disc partway into the slot, label side up. The player will pull the disc in. Once the disc is loaded, the numbers of the empty disc will blink on the display continuously.

If the next "DISC NO." is displayed when the slot is illuminated, you can then load another disc.

4. Load the remaining disc by following the same procedures 1 and 2. When you finished loading 6 discs, the CD player will begin to play the last CD loaded.

5. To load more than one disc but less than six, complete Steps 1 and 2.

When you have finished loading discs, press LOAD button to cancel the loading function or wait for 10 seconds. The CD player will begin to play the last CD loaded. As each CD starts to play, the DISC number will appear on the display.

* NOTICE

The disc player takes up to six discs. Do not try to load more than six.

2. Playing CD Button

- Press the CD Button to start CD playback, during radio operation or cassette tape playback.
- When discs are in the CD deck, if you press the CD button, the CD player will begin playing even if the radio or cassette player is being used.
- The CD player can be used when the ignition switch is in either the "ON" or "ACC" position.
- Push the CD button to turn on that function without pushing the Power ON-OFF control knob.

* NOTICE

- Do not stick paper or tape etc., on the label side or the recording side of any discs, as it may cause a malfunction.
- The unit can play a multi-session CD-R (recordable CD) and CD-RW (rewritable CD) that consists of more than two sessions.
Please refer to the manual of CD-R/CD-RW recorder or CD-R/CD-RW software for more information on finalization process.
- Depending on the recording status, some CD-Rs/CD-RWs may not play on this unit.



*** NOTICE**

Playback of MP3 and WMA file formats are supported. Load to play time for these formats may be longer due to the compressed nature of these discs.

3. CD EJECT Button

- When the  button is pressed with a CD loaded, the CD will eject.
- To eject all of the discs, press this button for one second or more.

4. TRACK UP/DOWN Button

- The desired track on the disc currently being played can be selected using the track number.
- Press  once to skip forward to the beginning of the next track.
- Press  once to skip back to the beginning of the track.
- Press  before playback begins to quickly move backward through a CD.

5. SCROLL Button

Press the button, and you can check the file names with more than 16 characters on MP3 CD(max 34 characters). The button doesn't work on file names less than 16 characters.

6. FF/REW Button

If you want to fast forward or reverse through the compact disc track, push and hold the FF or REW button. When you release the button, the compact disc player will resume playing.

7. EQ Button or AUX Button

Press the EQ button to select the CLASSIC, POPS, ROCK, JAZZ and OFF MODE for the desired tone quality. Each press of the button changes the display as follows;



- If the button is labeled AUX, it will change to AUX mode when you press the button, and the button has no EQ function.
- The AUX button is functional only if RSE unit is on.
- You can enjoy the RSE audio through the speakers in AUX mode.
- The speaker volume level is adjustable by VOLUME(+,-) key, on RSE unit or wireless remote control.
- * Refer to the "RSE" in this section for details RSE operation.
- * RSE : Rear Seat Entertainment System(A/V).

8. CD SCAN Button

- To playback the first 10 seconds of each track, press the CD SCAN button more than 0.8 seconds.
- To playback the first 10 seconds of each track in the selected folder, press the CD SCAN button within 0.8 seconds. (MP3 CD only)
- Press the CD SCAN button again within 10 sec. when you have reached the desired track.

9. BOOKMARK (MARK) Button

When the CD player unit is operating, the desired track on the disc can be bookmarked by using the MARK button.

- Press the MARK button for more than 0.8 seconds to bookmark the desired track.
"M" will be displayed on the LCD and "MEMORY(1~50)" will display for approximately five seconds with beep sound.
To play the bookmarked tracks, press the MARK button within 0.8 seconds and select the bookmarked track to play.
- To erase a bookmarked track, press the MARK button for more than 0.8 seconds. The unit will beep once when the bookmark is erased.

If you want to delete all tracks stored on Mark Memory, press FILE SEARCH Knob in the Mark Play mode for more than 0.8 seconds. You will hear a beep sound and all tracks will be deleted from Mark Memory with "MARK DELETE ALL" displayed on the LCD.

* NOTICE

Tracks stored on Mark Memory will be automatically erased after you eject CDs that contain those tracks.

10. REPEAT (RPT) Button

- To repeat the track you are currently listening to, press the RPT button.
To cancel, press it again.
- To repeat the music within selected CD, press the RPT button for more than 0.8 seconds.
To cancel, press it again for more than 0.8 seconds.
- To repeat the music within currently played folder, press the RPT button for more than 0.8 seconds.
To cancel, press it again (MP3 CD only).
- If you do not release RPT operation after all the tracks are played back, the unit will play back again from the first track.
This process will be continued until you push the button again or turn the power OFF then ON.

11. RANDOM (RDM) Button

With random, you can listen to the tracks in random, rather than sequential order on one disc.

To use random, do the following:

- Press the RDM button to listen to recorded tracks in random sequence. Press RDM again to cancel or turn the power OFF then ON. The unit defaults to playing tracks in sequential order.
- To listen to the music within the selected folder in random order, press the RDM button within a second. To cancel, press it again or turn the power OFF then ON. (MP3 CD only)

12. DISC UP/DOWN Button

- By pressing "DISC ^"/"DISC v" while CD changer is playing you can move backward or forward to the next disc and playback automatically begins.
- If any of the slots do not contain a CD, your car audio will skip the empty slot and play only those that contain a CD. When switching CD's, the LCD displays the selected CD's number.

13. FILE SEARCH Knob (TUNE Select Knob)

- You can skip the track (file) by turning the FILE SEARCH knob clockwise or counterclockwise.
After selecting the desired track (file), press the FILE SEARCH knob to playback the track (file).
If you do not press the FILE SEARCH knob within five seconds, the search will stop.

14. DIRECTORY SEARCH (DIR) Button

- You can move through the folder by pushing the DIR button to up (^) and down (v).
- After moving the desired folder, press the FILE SEARCH knob to play back in the selected folder. If you do not press the FILE SEARCH knob within 5 seconds, the folder searching function will be released. It can not be operated in a single folder.

* NOTICE

- To assure proper operation of the unit, keep the vehicle interior temperature within a normal range by using the vehicle's air conditioning or heating system.
- When replacing the fuse, replace it with a fuse having the correct capacity.
- Stored bookmarks are all erased when the car battery is disconnected or power to the vehicle is lost. If this occurs, the bookmarks will have to be reset.
- This equipment is designed to be used only in a 12 volt DC battery system with negative ground.
- This unit is made of precision parts. Do not attempt to disassemble or adjust any parts.
- Do not expose this equipment (including the speakers and tape) to water or excessive moisture.

⚠ WARNING

When driving your vehicle, be sure to keep the volume of the unit set low enough to allow you to hear sounds coming from the outside.

⚠ CAUTION

- Do not insert warped or poor quality discs into the CD player as damage to the unit may occur.
- Do not insert anything like coins into the player slot as damage to the unit may occur.
- Do not place beverages close to the audio system. The playback mechanism may be damaged if you spill them.
- Do not strike or allow anything to impact the audio system, damage to the system mechanisms could occur.
- Off-road or rough surface driving may cause the compact disc to skip. Do not use the compact disc when driving in such conditions as damage to the compact disc face could occur.
- Do not attempt to grab or pull the compact disc out while the disc is being pulled into the audio unit by the self-loading mechanism. Damage to the audio unit and compact disc could occur.
- Avoid using recorded compact discs in your audio unit. Original compact discs are recommended for best results.

REAR SEAT ENTERTAINMENT SYSTEM (IF EQUIPPED)

Welcome

The Rear Seat Entertainment (RSE) System is a compact, built-in, easy-to-use entertainment system designed to provide family fun while you are on the road. Enjoy great quality sound from the 11 speakers, or have a private, quiet viewing with the wireless headphones.

The display unit is mounted to the ceiling in the rear passenger area of the vehicle, allowing rear-seat passengers to play DVD movies, video CDs or music CDs. Users may also plug in a game platform or VHS player. Headphones, game cartridges and other accessories can be kept neatly out of the way in the 3rd-row armrest compartment.

System Overview

The RSE System includes a mounted color monitor with a built-in audio/video control panel and a DVD player. It also includes a remote control and two (2) sets of battery-operated wireless headphones (batteries are included).

Connections / Setup

The RSE system is designed to make your time on the road more enjoyable. Please follow these instructions carefully to get the most out of your RSE.

CAUTION

- **Refrain from using food or drinks near the RSE, the wireless headphones or the remote control.**
- **Direct sunlight may interfere with the headphone's operation and performance.**
- **Normal RSE operation cannot be guaranteed with unofficial duplicated discs.**
- **In order to prevent inadvertent battery discharge, the RSE will remain in standby mode when ignition switch is turn to ignition ON or accessory mode.**
- **Use of rear seat entertainment system without the engine running will reduce battery power.**

CAUTION

Disclaimer: The RSE system is programmed to the regional display formats for your region (NTSC or PAL). Please note that your RSE will not read DVDs from a different region.

*** NOTICE**

RSE operation is prevented during the first 2 seconds after the ignition switch is turned to ignition on or accessory mode.

The RSE system is already set up and ready for use. The system is always "awake" when the vehicle's ignition is turned on or when the vehicle is in "accessory power mode."

Close



RES_CLOSED_8111

Open



RES_OPEN_8111

To close the monitor, pull the bottom edge forward and push it up until it clicks into the stow-away position.

Folded



HEADPHONE8111

Spread



HEADPHONE8112

Viewing/Adjusting the Monitor

To view the monitor, locate the latch on the bottom center of the mounted unit and pull it forward. This will release the monitor from its locked, stow-away position. Use your hands to adjust the monitor into optimal viewing position. Do not touch the LCD panel itself to avoid damage or smudging.

Headphones

The RSE comes with two (2) sets of wireless headphones and four (4) AAA 1.5V batteries. Install the batteries by opening the compartment on the right side of the headphones. Each set of headphones requires two (2) AAA 1.5V batteries.



To turn the headphones on, push the button (1) once. Push the button again to turn the headphones off. The red LED indicator on the headphone identifies the On/Off status. The power status indicator is located on the left headphone.

The sound level of the headphones is controlled by the volume up[down] knob (2) located on the side of the headphones.

The headphones can be stored by folding the headphones.

*** NOTICE**

- Conserve the energy of your batteries by turning the headphones off when they are not in use. The on/off button is located on the left side of the headphones.
- The headphone has an automatic shutoff feature if an IR signal from the RSE units is not received after 20 seconds. This feature is used to prevent inadvertent battery discharging of the headphones.
- The life cycle of headphone's battery is usually 48 hours.
- In case of poor reception performance, please check the battery condition.
- The headphones are best used within 2-6 feet (0.6-1.8 m) of the RSE unit. Getting too close or too far away will cause poor audio reception.
- Audio from the vehicle's CD/radio cannot be heard through the headphones.



Audio Via Vehicle Speakers

To hear the audio from the RSE through the vehicle's speakers, the RSE must be selected by the Head Unit in the front of the vehicle. To select the RSE, press AUX button. To end the RSE audio through the vehicle's speakers, press AUX button again. When RSE is de-selected by the Head Unit, the headphones can still be used to hear audio.

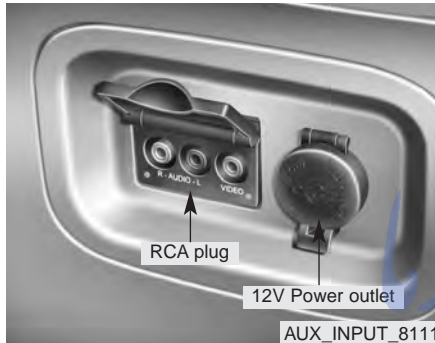

Connecting Other Devices to the RSE

Electronic devices such as video game systems, VHS players, Camcorder or etc, can be played through the RSE. These external devices can be connected to the unit via RCA plugs available throughout the vehicle. DC power for additional electronic equipment is provided by one of the 12-volt power outlets located in the dash, third row and cargo areas. Additional information can be found in the vehicle manual.

Press the SOURCE (SRC) Button to switch to the externally connected device. (AUX mode)

The RSE unit has an automatic video detection feature that will automatic switch to external device when the device is plugged into the auxiliary jacks in the vehicle.

Once the RSE has switched to the external device, you can make your selections by using the buttons on the external device. The RSE controls will not work for external devices. For example, to select a video game after the RSE has recognized the source, you must use the game controls, not the RSE controls, to choose a selection.

The RSE unit will automatically switch to the RSE mode when the external device is unplugged from the auxiliary jacks.

The display mode can be changed by DISP (DISP) button.

CAUTION

Connect only appropriate input sources to the RSE jacks. Connecting an incorrect input may cause damage to the player and/or the external electronic device.

* NOTICE

Only external devices that have an active video source - such as video game systems or VHS players - can be read by the RSE. The RSE will not play an external device that only has an audio source, such as a cassette player or other CD player.

* NOTICE

When using an external device connected to the power outlet, noise may occur during playback. If this happens, use the power source of the external device.

Cleaning of Display

If the LCD display becomes dusty or dirty, clean it by wiping gently with a soft, dry, clean cloth.

Using the DVD player

Disc compatibility

Your RSE player accepts and plays all DVDs in 4:3 (normal) and 16:9 (wide screen) video formats. With DVDs that offer multiple formats, the default format is 16:9 and will stay that way unless the user changes the format. (See “Display” to learn how to adjust the format.)

* NOTICE

- The DVD player has the capability to play DVD-Video, DVD-R, DVD-RW, CD-DA, CD-R, CD-RW and Video-CD.
- The DVD player has the capability to play CD-DA, DVD, VCD, PCM, Dolby Digital and DTS formats.
- Please refer to the appendix for the error messages.

Loading a Disc

Insert the disc part way into the load slot. The player will automatically grip the disc and pull it in the rest of the way. The player will display “reading” on the screen and show the “Kia Motors” logo before beginning the DVD.

The player is only capable of reading the bottom side of a disc. When inserting a single-sided disc, the label side should be up. When inserting a two-sided disc, the desired play side should be down.

* NOTICE

- Because there is no universal standard for DVD programming, your disc may behave differently than below. Some DVDs may present warning messages about unauthorized duplication, some will go directly to a menu and others may start playing the movie immediately.
- When the vehicle's ignition is active, the loading of any playable disc will cause the player to initialize and automatically play the disc. If a disc was playing prior to the ignition being turned off, it will not automatically replay once the ignition is turned on again. Instead, it will go into standby mode. Press the SRC or PLAY/PAUSE (⏮) button to “wake up” the unit and resume disc play.

Disc Protection

The player has an Auto-Reload Disc Protection feature to protect discs from accidental damage. If an ejected disc is not removed within 25 seconds after being ejected, it will be pulled back into the player. The disc will not begin playing. Disc can be played by the SRC or PLAY/PAUSE (⏮) buttons.

DVD Controls

You can control your DVD by using the buttons on the unit's control panel or by using the remote control. Instructions for the controls listed below are the same whether you are using the control panel or the remote control. However, there are functions that are only available from the remote control. These buttons and their functionality are discussed in the “REMOTE CONTROL” section beginning.

VIDEO MODE OPERATION (IF EQUIPPED)

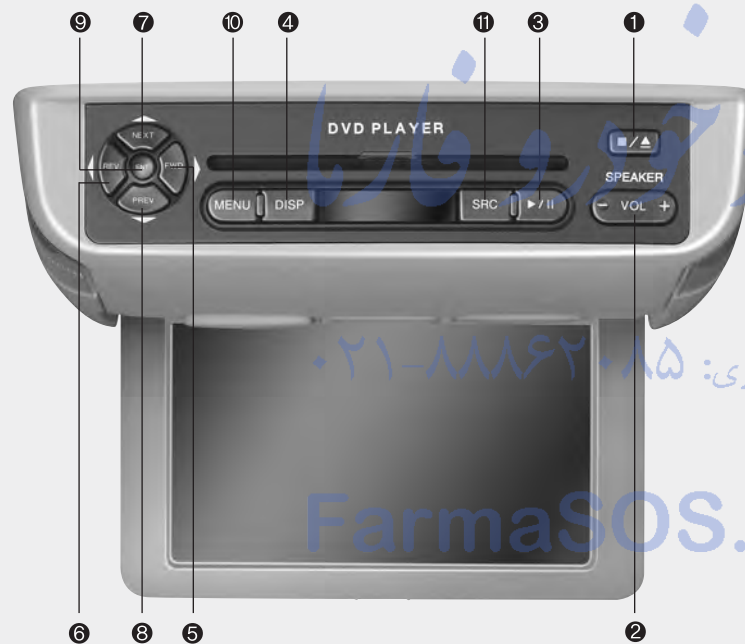

1. STOP/EJECT
2. SPEAKER VOLUME CONTROL
3. PLAY/PAUSE
4. DISPLAY
5. FORWARD
6. REVERSE
7. NEXT CHAPTER
8. PREVIOUS CHAPTER
9. ENTER
10. MENU
11. SOURCE

RES_OPEN_8111

* NOTICE

The RSE will enter standby mode when the vehicle ignition is turned off and back on. Press the SRC or PLAY/PAUSE (▶⏸) button to “wake up” the unit and resume disc play.

1. Stop/Eject

While the disc is playing, press the STOP/EJECT (◻/▲) button to stop disc play. When the disc has stopped, press the button again to eject the disc.

* NOTICE

The player has an Auto-Reload Disc Protection feature to protect discs from accidental damage. If an ejected disc is not removed within 25 seconds after being ejected, it will be pulled back into the player. This is to protect the disc from accidental damage.

2. Speaker Volume Control

You can adjust the volume one of two ways. First, if you are adjusting the volume for audio through the vehicle speakers, you can use the VOLUME button on the control panel or the remote control. This button is reserved for sending a signal to the vehicle speakers only, and will not adjust the headphone volume. Press “+” to increase the volume and “-” to decrease the volume.

Second, the volume on the wireless headphones can be adjusted by turning the VOL knob located on the left side of the headphones.

3. Play/Pause

You do not need to press the play button after first loading a DVD or VCD; it will start automatically by playing the first track or bringing up the disc menu.

If the disc does not automatically load, press PLAY/PAUSE (▶⏸) to play the DVD.

While playing a DVD, press PLAY/PAUSE (▶⏸) to pause the DVD. Press the button again to resume play.

4. Display

When the player is in DVD mode, press the DISP button to view the DVD title, chapter number and elapsed time and other information about the DVD currently playing.

It will also display brightness. There are “Day Time” brightness with brightest level and “Night Time” brightness which has 70% level of “Day Time” brightness. Adjust the level of brightness by pressing the REV(dimmer) or FWD(brighter) buttons.

The next time the player is turned on, it will return to the brightness level it was adjusted to when last used.

The RSE unit has two presets of display brightness. When the headlamp is turned on, the display brightness level will be dimmed as the preset. However, when the headlamp is turned off, the display brightness will return to the daytime brightness.

Press DISP to adjust the image format. The image format, also known as the aspect ratio, is a ratio of the height to width of the image on the screen. For example, a 4:3 ratio would mean an image that is 4 units by 3 units.

You have two options: 4:3 (normal) and 16:9 (widescreen). Press the display button to select the preferred aspect ratio.

When the RSE unit receives video signals from the AUX, the aspect ratio can be changed to 16:9 or 4:3 by the DISP button.

The aspect ratio information will automatically disappear if no button is pressed for three seconds.

5. Forward

There are three DVD and VCD fast forward speeds. Press and hold the FWD button for up to 2 seconds and the player will fast forward at 4 times the normal speed (8 times for VCDs). Hold the button for more than 2 seconds but less than 4 seconds and the player will fast forward at about 8 times the normal speed (20 times for VCDs). Hold the button for more than 4 seconds and the fast forward will increase to about 32 times the normal speed for both DVDs and VCDs. Press the FWD button again to stop fast forwarding and return to normal speed play.

6. Reverse

There are three DVD and VCD fast reverse speeds. Press and hold the REV button for up to 2 seconds and the player will reverse through the DVD at 4 times the normal speed (8 times for VCDs). Hold the button for more than 2 seconds but less than 4 seconds and the player will reverse at about 8 times the normal speed (20 times for VCDs). Hold the button for more than 4 seconds and the reverse will increase to 32 times the normal speed for both DVDs and VCDs.

Press the REV button again to stop reversing and return to normal speed play.

7. Next Chapter

While a DVD is playing, press the NEXT button to skip to the next chapter. The current chapter number is shown on the screen. Press and hold the NEXT button to move quickly through the chapters.

* NOTICE

Depending on the DVD, if NEXT is pressed during the last chapter on a DVD, a red circle with a "Invalid icon[⊙]" may be displayed, indicating an invalid button press.

8. Previous Chapter

Press the PREV button to skip to the beginning of the previous chapter. Press and hold the PREV button to move quickly through the chapters.

Depending on your DVD, if the PREV button is pressed during the first 8 seconds of the first chapter, the player will skip to the beginning of the last chapter of the DVD.

9. Enter

A momentary press shall initiate a select or enter function of a selected menu item.

10. Menu

DVDs may contain special programming or features that are accessed by using the menu. To use the menu with a DVD that is playing, press the MENU button once to display the DVD disc menu. Press the button a second time to exit the menu and return to the DVD program.

The menu is not available during disc initialization, the beginning credits or any copyright FBI warnings.

Features of your vehicle

When viewing a menu, pressing the MENU button again will automatically return to the movie at the point it was being viewed. You can also select "play" or any other option by using the NEXT, PREV, FWD and REV buttons.

Press the NEXT button to move the cursor up and the PREV button to move the cursor down the menu.

Press the FWD button to move the cursor to the right, and the REV button to move the cursor to the left.

* NOTICE

You must repeatedly push any button to move through several items. Pressing and holding any button will not advance the cursor beyond the position just moved.

Press ENTER to select the desired menu choice.

11. Source

Press the SOURCE button to switch from the RSE's internal DVD player to an external device such as a VCR or video game. The sound and images from the external source will be presented through the RSE.

Pressing the SRC button will switch between the following RSE states:

Playback state - will play DVDs, VCDs, and CDs

Auxiliary (AUX) state - will play video games and other external devices

When an external source is selected, the RSE's internal DVD player turns off. Press the SRC button to switch back from the external source to the internal DVD player.

If a disc is present in the DVD player, the disc will begin to play. If another source has been detected, such as a VCR or video game, the RSE will enter the AUX mode automatically and shall remain so until a disc is inserted or until the PLAY/SRC button is pressed on the RSE's front panel or on the remote control. If the vehicle ignition is on but the player isn't being used, the display will power off. The DVD mechanism will be in sleep mode, but the main RSE's controller will stay up to accept commands from the front panel controls or the remote control.

* NOTICE

The external device must be correctly connected to the RSE in order to play properly.

Using the CD Player

The RSE will play audio CDs in both the standard (12 cm) and mini-disc (8 cm) format.

* NOTICE

While the player will accept DVD ROMs and CD ROMs discs, the RSE cannot play discs in these formats and will eject them.

With power applied to your unit, insert the disc part way into the load slot. The player will automatically grip the CD disc, pull it the rest of the way in and begin playing.

CD Controls

The following functions are available when playing audio CDs.

AUDIO MODE OPERATION (IF EQUIPPED)



1. STOP/EJECT
2. VOLUME CONTROL
3. PLAY/PAUSE
4. DISPLAY
5. FORWARD
6. REVERSE
7. NEXT TRACK
8. PREVIOUS TRACK

FarmaSOS.com

RES_CLOSED_8111

Features of your vehicle

1. Stop/Eject

While the disc is playing, press the STOP/EJECT () button to stop disc play.

While the disc is stopped, press the STOP/EJECT () button again to eject the disc.

2. Volume Control



You can adjust the volume one of two ways. First, if you are adjusting the volume for audio through the vehicle speakers, you can use the VOLUME () button on the control panel or the remote control. Press “+” to increase the volume and “-” to decrease the volume. The volume level will be displayed on the head-unit, when the RSE unit volume level is adjusted from its control panel or remote control. This button does not affect headphone volume.

Second, you can adjust the volume on the wireless headphones by locating the VOL control wheel on the left side of the headphones. Roll the control wheel to adjust the volume.

3. Play/Pause

When an audio CD is inserted, the RSE will display the KIA logo, then automatically begin playing the first track. The track number and time elapsed for the current track is displayed.

If a CD is loaded and playing, press the PLAY/PAUSE () button to pause the CD. Press the button again to resume play.

If a CD is already loaded, stopping and playing the CD by pressing PLAY/PAUSE () button on the remote control; cycling the ignition and pressing play; or changing the source will cause the CD to begin playing at the point where it was stopped during the previous play. The player will automatically play this previous play position unless the STOP/EJECT () button is pressed.

At the end of the CD, the player will automatically return to the first track and continue playing.

4. Display

When the player is in DVD mode, press the DISP button to view the DVD title, chapter number and elapsed time and other information about the DVD currently playing.

The next time the player is turned on, it will return to the brightness level it was adjusted to when last used.

The RSE unit has two presets of display brightness. When the headlamp is turned on, the display brightness level will be dimmed as the preset. However, when the headlamp is turned off, the display brightness will return to the daytime brightness. Press DISP to adjust the image format. The image format, also known as the aspect ratio, is a ratio of the height to width of the image on the screen. For example, a 4:3 ratio would mean an image that is 4 units by 3 units. You have two options: 4:3 (normal) and 16:9 (widescreen). Press the display button to select the preferred aspect ratio.

When the RSE unit receives video signals from the AUX, the aspect ratio can be changed to 16:9 or 4:3 by the DISP button.

The aspect ratio information will automatically disappear if no button is pressed for three seconds.

5. Forward

There are two CD fast forward speeds. Press and hold the FWD button for up to 2 seconds and the player will fast forward at 3 times the normal speed. Hold the button for more than 2 seconds and the player will fast forward at about 10 times the normal speed. When the holding button is released, the RSE unit will automatically return to a play mode.

6. Reverse

There are two fast reverse speeds. The RSE unit will fast reverse at 3 times the normal speed, if the REV button is pressed. Hold the button for more than 2 seconds and the RSE unit will fast reverse at about 10 times the normal speed. When the button is released, the RSE unit will automatically return to a play mode.

7. Next Track

Press the NEXT button to skip to the beginning of the next track. The next track number is displayed on the screen. Press and hold the NEXT button for 2 seconds or more to move quickly through the tracks.

8. Previous Track

Press the PREV button to skip to the beginning of the current track.

Press the PREV button during the first 8 seconds of the current track to skip to the beginning of the previous track.

Press the PREV button during the first 8 seconds of the first track to skip to the beginning of the last track on the CD.

Press and hold the PREV button for 2 seconds or more to move quickly through the tracks.

Features of your vehicle



Using the Remote Control

In addition to having all the buttons and functionality listed in the DVD and CD Controls section, the remote control has several other buttons that offer additional functions. It is an infrared remote control, and must be pointed at the face of the RSE at a 45° angle for best results. It requires a CR2025 battery (included). The remote control has the following additional buttons:

* NOTICE

The RSE system is always “awake” when the vehicle's ignition is turned on or when the vehicle is in “accessory power mode.”

1. Stop

Pressing this button once will stop DVD or CD play. To eject a disc, you must use the eject button on the control panel.

2. Speaker Volume “+” and “-”

These buttons control the volume of the audio of a DVD or CD through the vehicle speakers, not the volume from headphones. Press “+” to turn the volume up and “-” to turn the volume down.

3. Play/Pause

When an audio CD(VCD/DVD) is inserted, the RSE will display the KIA logo, then automatically begin playing the first track. The track number and time elapsed for the current track is displayed.

If a CD(VCD/DVD) is loaded and playing, press the PLAY/PAUSE(▶/⏸) button to pause the CD(VCD/DVD). Press the button again to resume play.

If a CD(VCD/DVD) is already loaded, stopping and playing the CD(VCD/ DVD) by pressing PLAY/PAUSE(▶/⏸) button on the remote control; cycling the ignition and pressing play; or changing the source will cause the CD(VCD/DVD) to begin playing at the point where it was stopped during the previous play. The player will automatically play this previous play position unless the STOP/EJECT(⏹) button is pressed.

At the end of the CD(VCD/DVD), the player will automatically return to the first track and continue playing.

4. Display

When the player is in DVD mode, press the DISP button to view the DVD title, chapter number and elapsed time and other information about the DVD currently playing.

It will also display brightness. There are “Day Time” brightness with brightest level and “Night Time” brightness which has 70% level of “Day Time” brightness. Adjust the level of brightness by pressing the REV(dimmer) or FWD(brighter) buttons.

The next time the player is turned on, it will return to the brightness level it was adjusted to when last used.

The RSE unit has two presets of display brightness. When the headlamp is turned on, the display brightness level will be dimmed as the preset. However, when the headlamp is turned off, the display brightness will return to the daytime brightness.

Press DISP to adjust the image format. The image format, also known as the aspect ratio, is a ratio of the height to width of the image on the screen. For example, a 4:3 ratio would mean an image that is 4 units by 3 units. You have two options: 4:3 (normal) and 16:9 (widescreen). Press the display button to select the preferred aspect ratio.

When the RSE unit receives video signals from the AUX, the aspect ratio can be changed to 16:9 or 4:3 by the DISP button. The aspect ratio information will automatically disappear if no button is pressed for three seconds.

5. Forward

There are three DVD and VCD fast forward speeds. Press and hold the FWD button for up to 2 seconds and the player will fast forward at 4 times the normal speed (8 times for VCDs). Hold the button for more than 2 seconds but less than 4 seconds and the player will fast forward at about 8 times the normal speed (20 times for VCDs). Hold the button for more than 4 seconds and the fast forward will increase to about 32 times the normal speed for both DVDs and VCDs. Press the FWD button again to stop fast forwarding and return to normal speed play.

6. Reverse

There are three DVD and VCD fast reverse speeds. Press and hold the REV button for up to 2 seconds and the player will reverse through the DVD at 4 times the normal speed (8 times for VCDs). Hold the button for more than 2 seconds but less than 4 seconds and the player will reverse at about 8 times the normal speed (20 times for VCDs). Hold the button for more than 4 seconds and the reverse will increase to 32 times the normal speed for both DVDs and VCDs.

Press the REV button again to stop reversing and return to normal speed play.

7. Next

While a DVD is playing, press the NEXT button to skip to the next chapter. The current chapter number is shown on the screen. Press and hold the NEXT button to move quickly through the chapters.

* NOTICE

Depending on the DVD, if NEXT is pressed during the last chapter on a DVD, a red circle with a "Invalid icon[⊗]" may be displayed, indicating an invalid button press.

8. Previous

Press the PREV button to skip to the beginning of the previous chapter. Press and hold the PREV button to move quickly through the chapters.

Depending on your DVD, if the PREV button is pressed during the first 8 seconds of the first chapter, the player will skip to the beginning of the last chapter of the DVD.

9. Enter

A momentary press shall initiate a select or enter function of a selected menu item.

10. Menu

DVDs may contain special programming or features that are accessed by using the menu. To use the menu with a DVD that is playing, press the MENU button once to display the DVD disc menu. Press the button a second time to exit the menu and return to the DVD program.

The menu is not available during disc initialization, the beginning credits or any copyright FBI warnings.

When viewing a menu, pressing the MENU button again will automatically return to the movie at the point it was being viewed. You can also select "play" or any other option by using the NEXT, PREV, FWD and REV buttons.

Press the NEXT button to move the cursor up and the PREV button to move the cursor down the menu.

Press the FWD button to move the cursor to the right, and the REV button to move the cursor to the left.

*** NOTICE**

You must repeatedly push any button to move through several items. Pressing and holding any button will not advance the cursor beyond the position just moved.

Press ENTER to select the desired menu choice.

11. Source

Press the SOURCE button to switch from the RSE's internal DVD player to an external device such as a VCR or video game. The sound and images from the external source will be presented through the RSE.

Pressing the SRC button will switch between the following RSE states:

Playback state - will play DVDs, VCDs and CDs

Auxiliary (AUX) state - will play video games and other external devices

When an external source is selected, the RSE's internal DVD player turns off. Press the SRC button to switch back from the external source to the internal DVD player.

If a disc is present in the DVD player, the disc will begin to play. If another source has been detected, such as a VCR or video game, the RSE will enter the AUX mode automatically and shall remain so until a disc is inserted or until the PLAY/SRC button is pressed on the RSE's front panel or on the remote control. If the vehicle ignition is on but the player isn't being used, the display will power off. The DVD mechanism will be in sleep mode, but the main RSE's controller will stay up to accept commands from the front panel controls or the remote control.

*** NOTICE**

The external device must be correctly connected to the RSE in order to play properly.

12. Angle

Some DVDs offer different scene angles. If available on the DVD, the ANGLE button will show you the other available scene angles. If angle scenes are not available, then "Invalid icon[⊙]" will be displayed. Pressing the ANGLE button during CD play will do nothing.

13. Subscript

The SUBSC button allows you to display or remove language subtitles. If no language subtitles are available, the display will show an invalid icon[⊙]. Pressing the SUBSC button during CD play will do nothing.

14. Language

Pressing the LANG button will allow you to select your preferred language, if available. Select the language and then press enter. If no other languages are available, the display will show an invalid icon[⊙]. Pressing the LANG button during CD play will do nothing.

Features of your vehicle

15. Slow Play

There are 3 slow forward and 3 slow reverse speeds available when viewing DVDs. To review a DVD in slow motion, first press the PLAY/PAUSE (⏸) button to pause the DVD, then press either REV or FWD (◀ or ▶) on the remote control to select slow playback in either reverse or forward.

Pressing either the REV or FWD (◀ or ▶) on the remote control button once changes the player to 1/8 of normal speed. Press the button again to return to pause mode.

Press and hold either button for more than 2 seconds but less than 4 seconds and the player will switch to 1/4 of the normal speed. Hold either button for more than 4 seconds and the player will switch to 1/2 of the normal speed.

From the remote control for DVD, you can immediately switch to 1/8 forward or backward speed with the (◀, ▶) buttons. Press either button again to return to normal play.

While using the Slow Play feature, the current play speed is displayed on the screen.

Press PLAY again to resume normal play.

16. On/Off

This button will only turn off the DVD or CD and display, not the system itself. The system will remain on standby.

تلفن شبانه روزی: ۰۸۵ ۸۸۶۲ ۱-۱

FarmaSOS.com

Appendix

Messages

NON PLAYABLE MEDIA	An incompatible format disc is inserted, or the disc is not playable.
⊙[INVALID ICON]	Invalid button press: The PREV button was pressed during the first chapter of a DVD, or the NEXT button was pressed during the last chapter of a DVD.
NO DISC	Displayed with the PLAY button is pressed but not disc is in the player.
READING	The player is searching the disc to determine its format and check for any special programming.
STOP	A disc is inserted in the RSE but not playing.
DISC ERROR	The inserted disc is either scratched or otherwise damaged, and cannot be played.
REGION ERROR	The region code of the disc is different from the RSE DVD region setting. The RSE unit can only play disc from the intent region. (ie, Korean Region, US region, European region, etc...)

Technical Specifications

Input power requirements	12 volts nominal (10.5 to 15.5 volts) @ 5 amps nominal (10amps peak max)
A/V inputs	- Audio Input : 1 volts nominal (0.8 to 1.2 V) - Video Input : 1 volts nominal (0.7 to 1.4 V)

Features of your vehicle

Troubleshooting

Problem	Possible causes / solutions
The disc becomes stuck or blocked.	Press the STOP/EJECT button to release the disc. The player will attempt to eject the disc up to three times before performing the Auto-Reload function. Once the Auto-Reload function is complete, press the STOP/EJECT button again to release the disc from the player. If a disc is still stuck or blocked in the RSE unit, turn the ignition off and then on again to reset the RSE unit.
There is no audio in the headphones.	Verify that the headphone is equipped with batteries, and that the batteries are charged. Insert or replace 2 AAA batteries to resume headphone function.
The RSE does not work.	If the display does not show "NO DISC", then there is no power. Check the vehicle fuse. If the RSE still does not work, contact your authorized Kia dealer.
The remote control does not work.	Make sure you are pointing the remote control at the face of the RSE at a 45° angle. Change the battery. [Device requires one (1) CR2025 battery.] Use the control buttons on the RSE display panel. If the remote control still does not work, contact your authorized Kia dealer.
Continue receiving an invalid icon[⊗] when a button is pressed	Invalid button press. The function you are trying to perform is not available.

Before driving / 4-2
Key positions / 4-3
Starting the engine / 4-4
Automatic transaxle / 4-5
Cruise control system / 4-11
Brake system / 4-14
Electronic stability control / 4-19
Rear parking assist system / 4-22
Economical operation / 4-25

Driving your vehicle

4

Special driving conditions / 4-26
Winter driving / 4-28
Trailer towing / 4-28
Overloading / 4-34
Label information / 4-35

FarmaSOS.com

BEFORE DRIVING

Before entering vehicle:

- Be sure that all windows, outside mirror(s), and outside lights are clean.
- Check the condition of the tires.
- Check under the vehicle for any sign of leaks.
- Be sure there are no obstacles behind you if you intend to back up.

Necessary inspections

Fluid levels, such as engine oil, engine coolant, brake fluid, and washer fluid should be checked on a regular basis, with the exact interval depending on the fluid. Further details are provided in Section 6, Maintenance.

Before starting

- Close and lock all doors.
- Position the seat so that all controls are easily reached.
- Adjust the inside and outside rearview mirrors.
- Be sure that all lights work.
- Check all gauges.
- Check the operation of warning lights when the ignition switch is turned to the ON position.
- Release the parking brake and make sure the brake warning light goes out.

For safe operation, be sure you are familiar with your vehicle and its equipment.

WARNING - Driving under the influence of alcohol or drugs

Drinking and driving is dangerous. Drunk driving is the number one contributor to the highway death toll each year. Even a small amount of alcohol will affect your reflexes, perceptions and judgement. Driving while under the influence of drugs is as dangerous or more dangerous than driving drunk.

You are much more likely to have a serious accident if you drink or take drugs and drive.

If you are drinking or taking drugs, don't drive. Do not ride with a driver who has been drinking or taking drugs. Choose a designated driver or call a cab.

KEY POSITIONS



Illuminated ignition switch

Whenever front door is opened, the ignition switch will be illuminated for your convenience, provided the ignition switch is not in the ON position. The light will go off immediately when the ignition switch is turned on or go off after about 10 seconds when the door is closed.



Ignition switch and anti-theft steering column lock

Ignition switch position

LOCK

The steering wheel locks to protect against theft. The ignition key can be removed only in the LOCK position. When turning the ignition switch to the LOCK position, push the key inward at the ACC position and turn the key toward the LOCK position.

ACC (Accessory)

The steering wheel is unlocked and electrical accessories are operative.

ON

The warning lights can be checked before the engine is started. This is the normal running position after the engine is started.

Do not leave the ignition switch ON if the engine is not running to prevent battery discharge.

START

Turn the ignition key to the START position to start the engine. The engine will crank until you release the key; then it returns to the ON position. The brake warning lamp can be checked in this position.

* NOTICE

If difficulty is experienced in turning the ignition key to the START position, turn the steering wheel right and left to release the tension and then turn the key.

STARTING THE ENGINE

⚠ WARNING - Ignition key

- Never turn the ignition switch to LOCK or ACC while the vehicle is moving. This would result in loss of directional control and braking function, which could cause an accident.
- The anti-theft steering column lock is not a substitute for the parking brake. Before leaving the driver's seat, always make sure the shift lever is engaged in P (Park) for automatic transaxle, set the parking brake fully and shut the engine off. Unexpected and sudden vehicle movement may occur if these precautions are not taken.
- Never reach for the ignition switch, or any other controls through the steering wheel while the vehicle is in motion. The presence of your hand or arm in this area could cause a loss of vehicle control, an accident and serious bodily injury or death.
- Do not place any movable objects around the driver's seat as they may move while driving, interfere with the driver and lead to an accident.

⚠ WARNING

Always wear appropriate shoes when operating your vehicle. Unsuitable shoes (high heels, ski boots, etc.) may interfere with your ability to use the brake and accelerator pedal.

1. Make sure the parking brake is applied.
2. Place the transaxle shift lever in P (Park). Depress the brake pedal fully. *You can also start the engine when the shift lever is in the N (Neutral) position.*
3. Turn the ignition switch to START and hold it there until the engine starts (a maximum of 10 seconds), then release the key.
4. In extremely cold weather (below -18°C / 0°F) or after the vehicle has not been operated for several days, let the engine warm up without depressing the accelerator.

*Whether the engine is cold or warm, it should be started **without depressing the accelerator.***

⚠ CAUTION

If the engine stalls while you are in motion, do not attempt to move the shift lever to the P (Park) position. If traffic and road conditions permit, you may put the shift lever in the N (Neutral) position while the vehicle is still moving and turn the ignition switch to the START position in an attempt to restart the engine.

⚠ CAUTION

Do not engage the starter for more than 10 seconds. If the engine stalls out or fails to start, wait 5 to 10 seconds before re-engaging the starter. Improper use of the starter may damage it.

AUTOMATIC TRANSAXLE

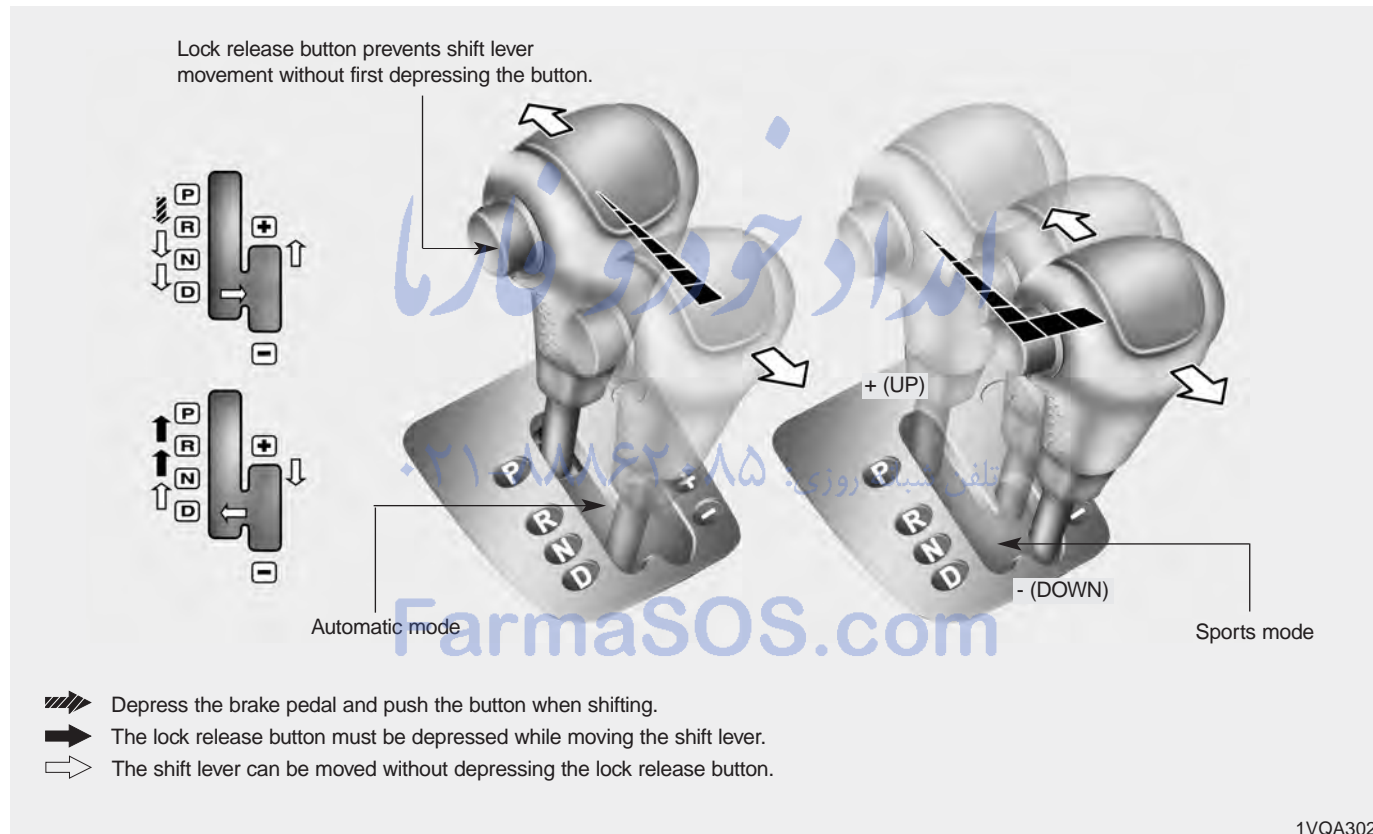

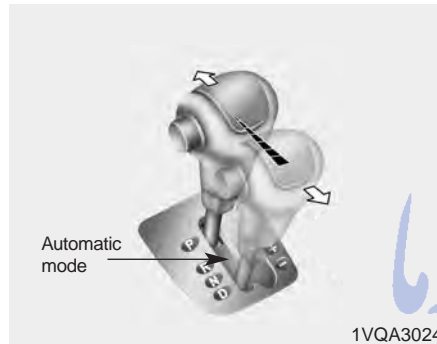

Automatic transaxle operation

All normal forward driving is done with the shift lever in the D (Drive) position.

To move the shift lever from the P (Park) position, the brake pedal must be depressed and the lock release button must be depressed.

For smooth operation, depress the brake pedal when shifting from N (Neutral) to a forward or reverse gear.

WARNING - Automatic transaxle

Before leaving the driver's seat, always make sure the shift lever is in the P (PARK) position; then set the parking brake fully and shut the engine off. Unexpected and sudden vehicle movement can occur if these precautions are not followed in the order identified.

CAUTION

- *To avoid damage to your transaxle, do not accelerate the engine in R (Reverse) or any forward gear position with the brakes on.*
- *When stopped on an upgrade, do not hold the vehicle stationary with engine power. Use the service brake or the parking brake.*
- *Do not shift from N (Neutral) or P (Park) into D (Drive), or R (Reverse) when the engine is above idle speed.*

Transaxle ranges

P (park)

Always come to a complete stop before shifting into P (Park). This position locks the transaxle and prevents the front wheels from rotating.

⚠ WARNING

- Shifting into P (Park) while the vehicle is in motion will cause the drive wheels to lock which will cause you to lose control of the vehicle.
- Do not use the P (Park) position in place of the parking brake. Always make sure the shift lever is latched in the P (Park) position so that it cannot be moved unless the lock release button is pushed in, AND set the parking brake fully.

(Continued)

(Continued)

- Before leaving the driver's seat, always make sure the shift lever is in the P (PARK) position. Set the parking brake fully, shut the engine off and take the key with you. Unexpected and sudden vehicle movement can occur if you do not follow these precautions in the order specified.
- Never leave a child unattended in a vehicle.

⚠ CAUTION

The transaxle may be damaged if you shift into P (Park) while the vehicle is in motion.

R (reverse)

Use this position to drive the vehicle backward.

⚠ CAUTION

Always come to a complete stop before shifting into or out of R (Reverse); you may damage the transaxle if you shift into R while the vehicle is in motion, except as explained in "Rocking the Vehicle", in this manual.

N (neutral)

The wheels and transaxle are not locked. The vehicle will roll freely even on the slightest incline unless the parking brake or service brakes are applied.

D (drive)

This is the normal forward driving position. The transaxle will automatically shift through a 5-gear sequence, providing the best fuel economy and power.

For extra power when passing another vehicle or climbing grades, depress the accelerator fully, at which time the transaxle will automatically downshift to the next lower gear.

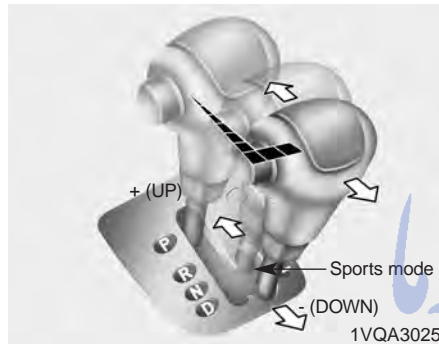

Sports mode

Whether the vehicle is stationary or in motion, sports mode is selected by pushing the shift lever from the "D" position into the manual gate. To return to "D" range operation, push the shift lever back into the main gate.

In sports mode, moving the shift lever backwards and forwards will allow you to make gearshifts rapidly. In contrast to a manual transaxle, the sports mode allows gearshifts with the accelerator pedal depressed.

Up (+) : Push the lever forward once to shift up one gear.

Down (-) : Pull the lever backwards once to shift down one gear.

* NOTICE

- In sports mode, the driver must execute upshifts in accordance with road conditions, taking care to keep the engine speed below the red zone.
- In sports mode, only the five forward gears can be selected. To reverse or park the vehicle, move the shift lever to the "R" or "P" position as required.
- In sports mode, downshifts are made automatically when the vehicle slows down. When the vehicle stops, 1st gear is automatically selected.

(Continued)

(Continued)

- In sports mode, when the engine rpm approaches the red zone, shift points are varied to upshift automatically.
- To maintain the required levels of vehicle performance and safety, the system may not execute certain gearshifts when the shift lever is operated.
- When driving on a slippery road, push the shift lever forward into the +(up) position. This causes the transaxle to shift into the 2nd gear which is better for smooth driving on a slippery road. Push the shift lever to the -(down) side to shift back to the 1st gear.

Moving up a steep grade from a standing start

To move up a steep grade from a standing start, depress the brake pedal, shift the shift lever to D (Drive). Select the appropriate gear depending on load weight and steepness of the grade, and release the parking brake. Depress the accelerator gradually while releasing the service brakes.

When accelerating from a stop on a steep hill, the vehicle may have a tendency to roll backwards. Shifting the shift lever into 2 (Second Gear) while in Sports mode will help prevent the vehicle from rolling backwards.

Shift lock system

For your safety, the automatic transaxle has a shift lock system which prevents shifting the transaxle out of P (Park) unless the brake pedal is depressed.

To shift the transaxle out of P (Park):

1. Depress and hold the brake pedal.
2. Start the engine or turn the ignition to the ON position.
3. Depress the lock release button and move the shift lever.

If the brake pedal is repeatedly depressed and released with the shift lever in the P (Park) position, a chattering noise near the shift lever may be heard. This is a normal condition.



Shift-lock override

If the shift lever should fail to move from the P (Park) position with the brake pedal depressed, continue depressing the brake, then do the following:

1. Carefully remove the cap covering the S/Lock override access hole which is located on the right side of the shift lever.



2. Insert the screwdriver into the access hole and press down on the screwdriver.

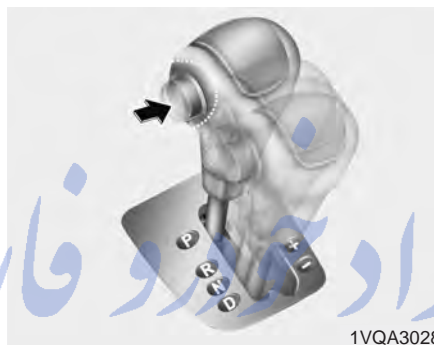

3. Depress the lock release button and move the shift lever.
4. Have your vehicle inspected by an authorized Kia dealership immediately.

Ignition key interlock system

The ignition key cannot be removed unless the shift lever is in the P (Park) position. If the ignition switch is in any other position, the key cannot be removed.

FarmaSOS.com

CRUISE CONTROL SYSTEM (IF EQUIPPED)

The cruise control system allows you to program the vehicle to maintain a constant speed without resting your foot on the accelerator pedal.

This system is designed to function above approximately 40 km/h (24 mph).

⚠ WARNING - Cruise control

Do not use the cruise control feature under the following conditions:

- Heavy or unsteady traffic
- Slippery or winding roads
- Situations that involve varying speeds



OVQ046002N



OVQ046003N

To set cruise control speed:

1. Pull the CRUISE ON-OFF button on the steering wheel to turn the system on. The CRUISE indicator light in the instrument cluster will illuminate.
2. Accelerate to the desired speed, which must be more than 40 km/h (24 mph).

⚠ WARNING

If the cruise control is left on, (CRUISE indicator light in the instrument cluster illuminated) the cruise control can be switched on accidentally. Keep the cruise control system off (CRUISE indicator light OFF) when cruise control is not in use.

3. Push the COAST/SET switch, and release it at the desired speed. The SET indicator light in the instrument cluster will illuminate. Release the accelerator at the same time. The desired speed will automatically be maintained.

The SET function cannot be activated until approximately 2 seconds after the CRUISE ON-OFF button has been engaged.

On a steep grade, the vehicle may momentarily slow down while going downhill.



To turn cruise control off, do one of the following:

- Pull the CRUISE ON-OFF button (the CRUISE indicator light in the instrument cluster will go OFF).
- Turn the ignition off.

Both of these actions cancel cruise control operation. If you want to resume cruise control operation, repeat the steps provided in "To Set Cruise Control Speed" on the previous page.



To increase cruise control set speed:

Follow either of these procedures:

- Push the RES/ACCEL switch and hold it. Your vehicle will accelerate. Release the switch at the speed you want.
- Push the RES/ACCEL switch and release it immediately. The cruising speed will increase by 2.0 km/h (1.2 mph) each time the RES/ACCEL switch is operated in this manner.

To cancel cruise control, do one of the following:

- Press the brake pedal.
- Shift into N (Neutral) with an automatic transaxle.
- Press the CANCEL switch located on the steering wheel.
- Press the COAST/SET and RES/ACCEL switches at the same time.

Each of these actions will cancel cruise control operation (the SET indicator light in the instrument cluster will go OFF), but it will not turn the system off. If you wish to resume cruise control operation, push the RES/ACCEL switch located on your steering wheel. You will return to your previously preset speed.

To temporarily accelerate with the cruise control on:

If you want to speed up temporarily when the cruise control is on, depress the accelerator pedal. Increased speed will not interfere with cruise control operation or change the set speed.

To return to the set speed, take your foot off the accelerator.



OVQ046003N



OVQ046005N

To decrease the cruising speed:

Follow either of these procedures:

- Push the COAST/SET switch and hold it. Your vehicle will gradually slow down. Release the switch at the speed you want to maintain.
- Push the COAST/SET switch and release it immediately. The cruising speed will decrease by 2.0 km/h (1.2 mph) each time the COAST/SET switch is operated in this manner.

To resume cruising speed at more than 40 km/h (24 mph):

If any method other than the CRUISE ON-OFF switch was used to cancel cruising speed and the system is still activated, the most recent set speed will automatically resume when the RES/ACCEL switch is pushed.

It will not resume, however, if the vehicle speed has dropped below 40 km/h (24 mph).

BRAKE SYSTEM

Power brakes

Your vehicle has power-assisted brakes that adjust automatically through normal usage.

In the event that the power-assisted brakes lose power because of a stalled engine or some other reason, you can still stop your vehicle by applying greater force to the brake pedal than you normally would. The stopping distance, however, will be longer.

When the engine is not running, the reserve brake power is partially depleted each time the brake pedal is applied. Do not pump the brake pedal when the power assist has been interrupted.

Pump the brake pedal only when necessary to maintain steering control on slippery surfaces.

In the event of brake failure

If service brakes fail to operate while the vehicle is in motion, you can make an emergency stop with the parking brake. The stopping distance, however, will be much greater than normal.

⚠ WARNING - Parking brake
Applying the parking brake while the vehicle is moving at normal speeds can cause a sudden loss of control of the vehicle. If you must use the parking brake to stop the vehicle, use great caution in applying the brake.

⚠ WARNING - Brakes

- Do not drive with your foot resting on the brake pedal. This will create abnormal high brake temperatures, excessive brake lining and pad wear, and increased stopping distances.

(Continued)

(Continued)

- When descending a long or steep hill, shift to a lower gear and avoid continuous application of the brakes. Continuous brake application will cause the brakes to overheat and could result in a temporary loss of braking performance.
- Wet brakes may result in the vehicle not slowing down at the usual rate and pulling to one side when the brakes are applied. Applying the brakes lightly will indicate whether they have been affected in this way. Always test your brakes in this fashion after driving through deep water. To dry the brakes, apply them lightly while maintaining a safe forward speed until brake performance returns to normal.

Disc brakes wear indicator

Your vehicle has disc brakes.

When your brake pads are worn and new pads are required, you will hear a high-pitched warning sound from your front brakes or rear brakes (if equipped). You may hear this sound come and go or it may occur whenever you depress the brake pedal.

Please remember that some driving conditions or climates may cause a brake squeal when you first apply (or lightly apply) the brakes. This is normal and does not indicate a problem with your brakes.

CAUTION
To avoid costly brake repairs, do not continue to drive with worn brake pads.

CAUTION
Always replace brake pads as complete front or rear axle sets.

WARNING - Brake wear
This brake wear warning sound means your vehicle needs service. If you ignore this audible warning, you will eventually lose braking performance, which could lead to a serious accident.

Parking on curbed streets

- When parking your vehicle on an uphill grade, park as close to the curb as possible and turn the front wheels away from the curb so that the front wheels will contact the curb if the vehicle moves backward.
- When parking your vehicle on a downhill grade, park as close to the curb as possible and turn the front wheels toward the curb so that the front wheels will contact the curb if the vehicle moves forward.

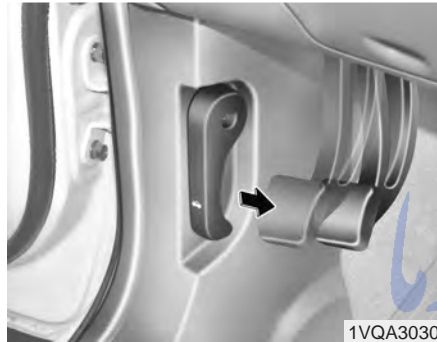

Parking brake

Applying the parking brake

To engage the parking brake, first apply the foot brake and then depress the parking brake pedal down as far as possible. In addition it is recommended that when parking the vehicle on a gradient, the shift lever should be in a low gear on manual transaxle vehicles or in the P (Park) position on automatic transaxle vehicles.

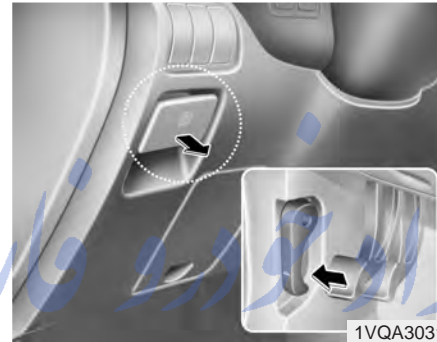

Releasing the parking brake

To release the parking brake, pull the parking brake release lever while applying the foot brake. The pedal will automatically extend to the fully released position. If the parking brake pedal does not release or does not release all the way, have the system checked by an authorized KIA dealer.

⚠ WARNING - Parking brake

- To prevent unintentional movement when stopped and leaving the vehicle, do not use the gearshift lever in place of the parking brake. Set the parking brake AND make sure the gearshift lever is securely positioned in P (Park) for automatic transaxle equipped vehicles.
- Never allow a person who is unfamiliar with the vehicle or children to touch the parking brake. If the parking brake is released unintentionally, serious injury may occur.

⚠ CAUTION

Driving with the parking brake applied will cause excessive brake pad and brake rotor wear.



Check the brake warning light by turning the ignition switch ON (do not start the engine). This light will be illuminated when the parking brake is applied with the ignition switch in the START or ON position.

Before driving, be sure the parking brake is fully released and the brake warning light is off.

If the brake warning light remains on after the parking brake is released, there may be a malfunction in the brake system. Immediate attention is necessary.

If at all possible, cease driving the vehicle immediately. If that is not possible, use extreme caution while operating the vehicle and only continue to drive the vehicle until you can reach a safe location or repair shop.

Anti-lock brake system (ABS)

⚠ WARNING - ABS

Your ABS is not a substitute for good driving judgement. You can still have an accident. In fact, your ABS will probably not be able to prevent an accident in the following driving conditions:

- Dangerous driving, such as neglecting safety precautions, speeding, or driving too close to the vehicle in front of you.
- Driving at high speed in situations providing considerably less traction, such as wet conditions where hydroplaning could occur.
- Driving too fast on poor road surfaces. The ABS is designed to improve maximum braking effectiveness on typical highways and roads in good condition. On poor road surfaces in poor condition, the ABS may actually reduce braking effectiveness.

The ABS continuously senses the speed of the wheels. If the wheels are going to lock, the ABS system repeatedly modulates the hydraulic brake pressure to the wheels.

When you apply your brakes under conditions which may lock the wheels, you may hear a “tik-tik” sound from the brakes, or feel a corresponding sensation in the brake pedal. This is normal and it means your ABS is active.

In order to obtain the maximum benefit from your ABS in an emergency situation, do not attempt to modulate your brake pressure and do not try to pump your brakes. Press your brake pedal as hard as possible or as hard as the situation warrants and allow the ABS to control the force being delivered to the brakes.

Driving your vehicle

- Even with the anti-lock brake system, your vehicle still requires sufficient stopping distance. Always maintain a safe distance from the vehicle in front of you.
- Always slow down when cornering. The anti-lock brake system cannot prevent accidents resulting from excessive speeds.
- On loose or uneven road surfaces, operation of the anti-lock brake system may result in a longer stopping distance than for vehicles equipped with a conventional brake system.



CAUTION

- *If the ABS warning light is on and stays on, you may have a problem with the ABS. In this case, however, your regular brakes will work normally.*
- *The ABS warning light will stay on for approximately 3 seconds after the ignition switch is ON. During that time, the ABS will go through self-diagnosis and the light will go off if everything is normal. If the light stays on, you may have a problem with your ABS. Contact an authorized Kia dealer as soon as possible.*

CAUTION

- *When you drive on a road having poor traction, such as an icy road, and operate your brakes continuously, the ABS will be active continuously and the ABS warning light may illuminate. Pull your car over to a safe place and stop the engine.*
- *Restart the engine. If the ABS warning light is off, then your ABS system is normal. Otherwise, you may have a problem with the ABS. Contact an authorized Kia dealer as soon as possible.*

* NOTICE

When you jump start your vehicle because of a drained battery, the engine may not run as smoothly and the ABS warning light may turn on at the same time. This happens because of the low battery voltage. It does not mean your ABS is malfunctioning.

- Do not pump your brakes!
- Have the battery recharged before driving the vehicle.

ELECTRONIC STABILITY CONTROL (IF EQUIPPED)



* The location of the ESC OFF button may be changed depending on your model.

The Electronic Stability Control (ESC) monitors information from various vehicle sensors and then compares the driver's commands with the actual behavior of the vehicle. If an unstable condition occurs - a sudden evasive movement for example - ESC intervenes within fractions of a second via the engine computer and brake system and attempts to stabilize the vehicle.

ESC operation

ESC ON condition



- When the ignition is turned ON, ESC and ESC OFF indicator lights illuminate for approximately 3 seconds, then ESC is turned on.
- Press the ESC OFF button for at least half a second after turning the ignition ON to turn ESC off. (ESC OFF indicator will illuminate). To turn the ESC on, press the ESC OFF button (ESC OFF indicator light will go off).
- When starting the engine, you may hear a slight ticking sound. This is the ESC performing an automatic system self-check and does not indicate a problem.

When operating



When the ESC is in operation, ESC indicator light blinks.

- When the Electronic Stability Control is operating properly, you can feel a slight pulsation in the vehicle. This is only the effect of brake control and indicates nothing unusual.
- When moving out of the mud or slippery road, pressing the accelerator pedal may not cause the engine rpm (revolutions per minute) to increase.

ESC operation off

ESC OFF state

**ESC
OFF**

- To cancel ESC operation, press the ESC OFF button (ESC OFF indicator light illuminates).
- If the ignition switch is turned to LOCK position when ESC is off, ESC remains off. Upon restarting the engine, the ESC will automatically turn on again.

■ ESC indicator light (blinks)

ESC

■ ESC OFF indicator light (comes on)

**ESC
OFF**

⚠ WARNING

The Electronic Stability Control system is only a driving aid; use precautions for safe driving by slowing down on curved, snowy, or icy roads. Drive slowly and don't attempt to accelerate whenever the ESC indicator light is blinking, or when the road surface is slippery.

Indicator light

When ignition switch is turned to ON, the indicator light illuminates, then goes off if ESC system is operating normally.

The ESC indicator light blinks whenever ESC is operating.

ESC OFF indicator light comes on when either the ESC is turned off with the button, or ESC fails to operate when turned on.

FarmaSOS.com

ESC OFF usage

When driving

- It's a good idea to keep the ESC turned on for daily driving whenever possible.
- To turn ESC off while driving, press the ESC OFF button while driving on a flat road surface.

Never press ESC OFF button while ESC is operating (ESC indicator light blinks).

If ESC is turned off while ESC is operating, the vehicle may slip out of control.

* NOTICE

- When operating the vehicle on a dynamometer, ensure that the ESC is turned off (ESC OFF light illuminated). If the ESC is left on, it may prevent the vehicle speed from increasing, and result in false diagnosis.
- Turning the ESC off does not affect ABS or brake system operation.

⚠ WARNING

Never press the ESC OFF button while ESC is operating.

If the ESC is turned off while ESC is operating, the vehicle may go out of control.

To turn ESC off while driving, press the ESC OFF button while driving on a flat road surface.

REAR PARKING ASSIST SYSTEM (IF EQUIPPED)



1VQA2098

The rear parking assist system assists the driver during backward movement of the vehicle by chiming if any object is sensed within a distance of 120 cm (47 in.) behind the vehicle. This system is a supplemental system and it is not intended to nor does it replace the need for extreme care and attention of the driver. The sensing range and objects detectable by the back sensors are limited. Whenever backing-up, pay as much attention to what is behind you as you would in a vehicle without a rear parking assist system.

⚠ WARNING

The rear parking assist system is a supplementary function only. The operation of the rear parking assist system can be affected by several factors (including environmental conditions). It is the responsibility of the driver to always check the area behind the vehicle before backing up.

Operation of the rear parking assist system

Operating condition

- This system will activate when backing up with the ignition key ON.
If the vehicle is moved at speed over 5 km/h (3 mph), the system may not activate correctly.
- The sensing distance while the rear parking assist system is in operation is approximately 120 cm (47 in.).
- When more than two objects are sensed at the same time, the closest one will be recognized first.

Types of warning sound

- When an object is 120 cm to 81 cm (47 in. to 32 in.) from the rear bumper : Buzzer beeps intermittently
- When an object is 80 cm to 41 cm (31 in. to 16 in.) from the rear bumper : Buzzer beeps more frequently
- When an object is within 40 cm (15 in.) of the rear bumper : Buzzer sounds continuously.

Non-operational conditions of rear parking assist system

Rear parking assist system may not operate normally when:

1. Moisture is frozen to the sensor. (It will operate normally when moisture melts.)
2. Sensor is covered with foreign matter, such as snow or water, or the sensor cover is blocked. (It will operate normally when the material is removed or the sensor is no longer blocked.)
3. Driving on uneven road surfaces (unpaved roads, gravel, bumps, gradient).
4. Objects generating excessive noise (vehicle horns, loud motorcycle engines, or truck air brakes) are within range of the sensor.
5. Heavy rain or water spray exists.
6. Wireless transmitters or mobile phones are within range of the sensor.
7. Sensor is covered with snow.
8. Trailer towing

Detecting range may decrease when:

1. Sensor is stained with foreign matter such as snow or water. (Sensing range will return to normal when removed.)
2. Outside air temperature is extremely hot or cold.

Following objects may not be recognized by the sensor:

1. Sharp or slim objects such as ropes, chains or small poles.
2. Objects which tend to absorb sensor frequency such as clothes, spongy material or snow.
3. Undetectable objects smaller than 1 m (40 in.) and narrower than 14 cm (6 in.) in diameter.

CAUTION

1. *The rear parking assist system may not sound sequentially depending on the speed and shapes of the objects detected.*
2. *The rear parking assist system may malfunction if the vehicle bumper height or sensor installation has been modified or damaged. Any non-factory installed equipment or accessories may also interfere with the sensor performance.*
3. *Sensor may not recognize objects less than 40 cm (15 in.) from the sensor, or it may sense an incorrect distance. Use caution.*
4. *When sensor is frozen or stained with snow, dirt, or water, sensor may be inoperative until the stains are removed using a soft cloth.*
5. *Do not push, scratch or strike the sensor. Sensor damage could occur.*

⚠ CAUTION

This system can only sense objects within the range and location of the sensors; it can not detect objects in other areas where sensors are not installed. Also, small or slim objects, such as poles or objects located between sensors may not be detected by the sensors.

Always visually check behind the vehicle when driving back up.

Be sure to inform any drivers in the vehicle that may be unfamiliar with the system regarding the systems capabilities and limitations.

Your new vehicle warranty does not cover any accidents or damage to the vehicle or its occupants due to rear parking assist system malfunction. Always drive safely and cautiously.

⚠ WARNING

Pay close attention when the vehicle is driven close to objects on the road, particularly pedestrians, especially children. Be aware that some objects may not be detected by the sensors, due to the object's distance, size or material, all of which can limit the effectiveness of the sensor. Always perform a visual inspection to make sure the vehicle is clear of all obstructions before moving the vehicle in any direction.

*** NOTICE**

If you don't hear an audible warning sound or if the buzzer sounds intermittently when shifting the gear to "R" position, this may indicate a malfunction in the rear parking assist system. If this occurs, have your vehicle checked by an authorized Kia dealer as soon as possible.

ECONOMICAL OPERATION

Your vehicle's fuel economy depends mainly on your style of driving, where you drive and when you drive.

Each of these factors affects how many kilometers (miles) you can get from a liter (gallon) of fuel. To operate your vehicle as economically as possible, use the following driving suggestions to help save money in both fuel and repairs:

- Avoid lengthy warm-up idling. Once the engine is running smoothly, begin driving. Remember, engine warm-up may take a little longer on cold days.
- Save fuel by accelerating slowly after stopping.
- Keep the engine in tune and follow the recommended periodic maintenance schedule. This will increase the life of all parts and lower your operating costs.
- Do not use the air conditioner unnecessarily.
- Slow down when driving on rough roads.
- For longer tire life and better fuel economy, always keep the tires inflated to the recommended pressures.
- Maintain a safe distance from other vehicles to avoid sudden stops. This will reduce wear on brake linings and pads. Driving in such a way will also save fuel because extra fuel is required to accelerate back to driving speed.
- Do not carry unnecessary weight in the vehicle.
- Do not rest your foot on the brake pedal while driving. This can cause needless wear, possible damage to the brakes, and poor fuel economy.
- Improper wheel alignment results in faster tire wear and lower fuel economy.
- Open windows at high speeds can reduce fuel economy.
- Fuel economy is less in crosswinds and headwinds. To help offset some of this loss, slow down when driving in these conditions.

Keeping a vehicle in good operating condition is important both for economy and safety. Therefore, have an authorized Kia dealer perform scheduled inspections and maintenance.

⚠ WARNING - Engine off during motion

Never turn the engine off to coast down hills or anytime the vehicle is in motion. The power steering and power brakes will not function properly without the engine running. Instead, keep the engine on and downshift to an appropriate gear for engine braking effect. In addition, turning off the ignition while driving could engage the steering wheel lock resulting in loss of vehicle steering which could cause serious injury or death.

FarmaSOS.com

SPECIAL DRIVING CONDITIONS

Hazardous driving conditions

When hazardous driving conditions are encountered such as water, snow, ice, mud, sand, or similar hazards, follow these suggestions:

- Drive cautiously and allow extra distance for braking.
- Avoid sudden movements in braking or steering.
- When braking with non-ABS brakes pump the brake pedal with a light up-and-down motion until the vehicle is stopped.

⚠ WARNING - ABS

Do not pump the brake pedal on a vehicle equipped with ABS.

- If stalled in snow, mud, or sand, use second gear. Accelerate slowly to avoid spinning the drive wheels.
- Use sand, rock salt or other non-slip material under the drive wheels to provide traction when stalled in ice, snow, or mud.

⚠ WARNING - Downshifting

Downshifting with an automatic transaxle, while driving on slippery surfaces can cause an accident. The sudden change in tire speed could cause the tires to skid. Be careful when downshifting on slippery surfaces.

Rocking the vehicle

If it is necessary to rock the vehicle to free it from snow, sand, or mud, first turn the steering wheel right and left to clear the area around your front wheels. Then, shift back and forth between R (Reverse) and any forward gear in vehicles equipped with an automatic transaxle. Do not race the engine, and spin the wheels as little as possible. If you are still stuck after a few tries, have the vehicle pulled out by a tow vehicle to avoid engine over-heating and possible damage to the transaxle.

⚠ CAUTION

Prolonged rocking may cause engine over-heating, transaxle damage or failure, and tire damage.

⚠ WARNING - Spinning tires

Do not spin the wheels, especially at speeds more than 56 km/h (35 mph). Spinning the wheels at high speeds when the vehicle is stationary could cause a tire to overheat, explode and injure bystanders.

⚠ CAUTION

The ESC system (if equipped) should be turned OFF prior to rocking the vehicle.

⚠ WARNING

If your vehicle becomes stuck in snow, mud, sand, etc., then you may attempt to rock the vehicle free by moving it forward and backward. Do not attempt this procedure if people or objects are anywhere near the vehicle. During the rocking operation the vehicle may suddenly move forward or backward as it becomes unstuck, causing injury or damage to nearby people or objects.

Driving at night

Because night driving presents more hazards than driving in the daylight, here are some important tips to remember:

- Slow down and keep more distance between you and other vehicles, as it may be more difficult to see at night, especially in areas where there may not be any street lights.
- Adjust your mirrors to reduce the glare from other driver's headlights.
- Keep your headlights clean and properly aimed on vehicles not equipped with the automatic headlight aiming feature. Dirty or improperly aimed headlights will make it much more difficult to see at night.
- Avoid staring directly at the headlights of oncoming vehicles. You could be temporarily blinded, and it will take several seconds for your eyes to readjust to the darkness.

Driving in the rain

Rain and wet roads can make driving dangerous, especially if you're not prepared for the slick pavement. Here are a few things to consider when driving in the rain:

- A heavy rainfall will make it harder to see and will increase the distance needed to stop your vehicle, so slow down.
- Keep your windshield wiping equipment in good shape. Replace your windshield wiper blades when they show signs of streaking or missing areas on the windshield.
- If your tires are not in good condition, making a quick stop on wet pavement can cause a skid and possibly lead to an accident. Be sure your tires are in good shape.
- Turn on your headlights to make it easier for others to see you.
- Driving too fast through large puddles can affect your brakes. If you must go through puddles, try to drive through them slowly.
- If you believe you may have gotten your brakes wet, apply them lightly while driving until normal braking operation returns.

Driving in flooded areas

Avoid driving through flooded areas unless you are sure the water is no higher than the bottom of the wheel hub. Drive through any water slowly. Allow adequate stopping distance because brake performance may be affected.

After driving through water, dry the brakes by gently applying them several times while the vehicle is moving slowly.

WINTER DRIVING

- We recommend that you carry emergency equipment, including a window scraper, windshield de-icer, a bag of sand or salt, flares, a small shovel and jumper cables.
- Make sure you have sufficient ethylene-glycol coolant in the radiator.
- Check the battery condition and cables. Cold temperatures reduce the capacity of any battery, so it must be in excellent condition to provide enough winter starting power.
- Make sure the engine oil viscosity is suitable for cold weather.
- Check the ignition system for loose connections and damage.
- Use antifreeze-formulated windshield washer fluid. (Do not use engine coolant antifreeze.)
- Do not use the parking brake if it might freeze. When parking, shift to P (Park) with an automatic transaxle and block the rear wheels.

Snow tires

If you mount snow tires on your Kia, make sure they are radial tires of the same size and load range as the original tires. Mount snow tires on all four wheels to balance your vehicle's handling in all weather conditions. Keep in mind that the traction provided by snow tires on dry roads may not be as high as your vehicle's original equipment tires. You should drive cautiously even when the roads are clear. Check with the tire dealer for maximum speed recommendations.

⚠ WARNING - Snow tire size
Snow tires should be equivalent in size and type to the vehicle's standard tires. Otherwise, the safety and handling of your vehicle may be adversely affected.

Do not install studded tires without first checking local, state and municipal regulations for possible restrictions against their use.

TRAILER TOWING

⚠ WARNING - Towing a trailer

If you don't use the correct equipment and drive improperly, you can lose control when you pull a trailer. For example, if the trailer is too heavy, the brakes may not work well - or even at all. You and your passengers could be seriously or fatally injured. Pull a trailer only if you have followed all the steps in this section.

⚠ WARNING - Weight limits

Before towing, make sure the total trailer weight, gross combination weight, gross vehicle weight, gross axle weight and trailer tongue load are all within the limits.

Item		kg (lbs.)
Maximum trailer weight	Without trailer brakes	453 (1000)
	With trailer brakes	1587 (3500)
Maximum permissible static vertical load on the coupling device		158 (350)

CAUTION

Pulling a trailer improperly can damage your vehicle and result in costly repairs not covered by your warranty. To pull a trailer correctly, follow the advice in this section.

Your vehicle can tow a trailer. To identify what the vehicle trailering capacity is for your vehicle, you should read the information in “Weight of the Trailer” that appears later in this section.

Remember that trailering is different than just driving your vehicle by itself. Trailering means changes in handling, durability, and fuel economy. Successful, safe trailering requires correct equipment, and it has to be used properly.

This section contains many time-tested, important trailering tips and safety rules. Many of these are important for your safety and that of your passengers. Please read this section carefully before you pull a trailer.

Load-pulling components such as the engine, transaxle, wheel assemblies, and tires are forced to work harder against the load of the added weight. The engine is required to operate at relatively higher speeds and under greater loads. This additional burden generates extra heat. The trailer also adds considerably to wind resistance, increasing the pulling requirements.

Hitches

It's important to have the correct hitch equipment. Crosswinds, large trucks going by, and rough roads are a few reasons why you'll need the right hitch. Here are some rules to follow:

- Will you have to make any holes in the body of your vehicle when you install a trailer hitch? If you do, then be sure to seal the holes later when you remove the hitch.
If you don't seal them, deadly carbon monoxide (CO) from your exhaust can get into your vehicle, as well as dirt and water.
- The bumpers on your vehicle are not intended for hitches. Do not attach rental hitches or other bumper-type hitches to them. Use only a frame-mounted hitch that does not attach to the bumper.

Driving your vehicle

Safety chains

You should always attach chains between your vehicle and your trailer. Cross the safety chains under the tongue of the trailer so that the tongue will not drop to the road if it becomes separated from the hitch.

Instructions about safety chains may be provided by the hitch manufacturer or by the trailer manufacturer. Follow the manufacturer's recommendation for attaching safety chains. Always leave just enough slack so you can turn with your trailer. And, never allow safety chains to drag on the ground.

Trailer brakes

If your trailer weighs more than the maximum trailer weight without trailer brakes loaded, then it needs its own brakes and they must be adequate. Be sure to read and follow the instructions for the trailer brakes so you'll be able to install, adjust and maintain them properly.

- Don't tap into your vehicle's brake system.

⚠ WARNING - Trailer brakes
Do not use a trailer with its own brakes unless you are absolutely certain that you have properly set up the brake system. This is not a task for amateurs. Use an experienced, competent trailer shop for this work.

Driving with a trailer

Towing a trailer requires a certain amount of experience. Before setting out for the open road, you must get to know your trailer. Acquaint yourself with the feel of handling and braking with the added weight of the trailer. And always keep in mind that the vehicle you are driving is now a good deal longer and not nearly so responsive as your vehicle is by itself.

Before you start, check the trailer hitch and platform, safety chains, electrical connector(s), lights, tires and mirror adjustment. If the trailer has electric brakes, start your vehicle and trailer moving and then apply the trailer brake controller by hand to be sure the brakes are working. This lets you check your electrical connection at the same time.

During your trip, check occasionally to be sure that the load is secure, and that the lights and any trailer brakes are still working.

Following distance

Stay at least twice as far behind the vehicle ahead as you would when driving your vehicle without a trailer. This can help you avoid situations that require heavy braking and sudden turns.

Passing

You'll need more passing distance up ahead when you're towing a trailer. And, because of the increased vehicle length, you'll need to go much farther beyond the passed vehicle before you can return to your lane.

Backing up

Hold the bottom of the steering wheel with one hand. Then, to move the trailer to the left, just move your hand to the left. To move the trailer to the right, move your hand to the right. Always back up slowly and, if possible, have someone guide you.

Making turns

When you're turning with a trailer, make wider turns than normal. Do this so your trailer won't strike soft shoulders, curbs, road signs, trees, or other objects. Avoid jerky or sudden maneuvers. Signal well in advance.

Turn signals when towing a trailer

When you tow a trailer, your vehicle has to have a different turn signal flasher and extra wiring. The green arrows on your instrument panel will flash whenever you signal a turn or lane change. Properly connected, the trailer lights will also flash to alert other drivers you're about to turn, change lanes, or stop.

When towing a trailer, the green arrows on your instrument panel will flash for turns even if the bulbs on the trailer are burned out. Thus, you may think drivers behind you are seeing your signals when, in fact, they are not. It's important to check occasionally to be sure the trailer bulbs are still working. You must also check the lights every time you disconnect and then reconnect the wires.

Do not connect a trailer lighting system directly to your vehicle's lighting system. Use only an approved trailer wiring harness.

Your Authorized Kia Dealer can assist you in installing the wiring harness.

Driving on grades

Reduce speed and shift to a lower gear before you start down a long or steep downgrade. If you don't shift down, you might have to use your brakes so much that they would get hot and no longer operate efficiently.

On a long uphill grade, shift down and reduce your speed to around 70 km/h (45 mph) to reduce the possibility of engine and transaxle overheating.

If your trailer weighs more than the maximum trailer weight without trailer brakes and you have an automatic transaxle, you should drive in D (Drive) when towing a trailer.

Operating your vehicle in D (Drive) when towing a trailer will minimize heat build up and extend the life of your transaxle.

⚠ WARNING
Failure to use an approved trailer wiring harness could result in damage to the vehicle electrical system and/or personal injury.

CAUTION

- *When towing a trailer on steep grades (in excess of 6%) pay close attention to the engine coolant temperature gauge to ensure the engine does not overheat. If the needle of the coolant temperature gauge moves across the dial towards "H" (HOT), pull over and stop as soon as it is safe to do so, and allow the engine to idle until it cools down. You may proceed once the engine has cooled sufficiently.*
- *You must decide driving speed depending on trailer weight and uphill grade to reduce the possibility of engine and transaxle overheating.*

Parking on hills

Generally, you should not park your vehicle, with a trailer attached, on a hill. People can be seriously or fatally injured, and both your vehicle and the trailer can be damaged if they begin a downhill trajectory.

WARNING - Parking on a hill

Parking your vehicle on a hill with a trailer attached could cause serious injury or death, should the trailer break loose.

However, if you ever have to park your trailer on a hill, here's how to do it:

1. Apply your brakes, but don't shift into gear.
2. Have someone place chocks under the trailer wheels.
3. When the wheel chocks are in place, release the brakes until the chocks absorb the load.
4. Reapply the brakes. Apply your parking brake, and then shift to P (Park) for an automatic transaxle.
5. Release the brakes.

WARNING - Parking brake

It can be dangerous to get out of your vehicle if the parking brake is not firmly set.

If you have left the engine running, the vehicle can move suddenly. You or others could be seriously or fatally injured.

When you are ready to leave after parking on a hill

1. With the automatic transaxle in P (Park), apply your brakes and hold the brake pedal down while you:
 - Start your engine;
 - Shift into gear; and
 - Release the parking brake.
2. Slowly remove your foot from the brake pedal.
3. Drive slowly until the trailer is clear of the chocks.
4. Stop and have someone pick up and store the chocks.

Maintenance when trailer towing

Your vehicle will need service more often when you regularly pull a trailer. Important items to pay particular attention to include engine oil, automatic transaxle fluid, axle lubricant and cooling system fluid. Brake condition is another important item to frequently check. Each item is covered in this manual, and the Index will help you find them quickly. If you're trailering, it's a good idea to review these sections before you start your trip. Don't forget to also maintain your trailer and hitch. Follow the maintenance schedule that accompanied your trailer and check it periodically. Preferably, conduct the check at the start of each day's driving. Most importantly, all hitch nuts and bolts should be tight.

CAUTION

- ***Due to higher load during trailer usage, overheating might occur in hot days or during uphill driving. If the coolant gauge indicates over-heating, switch off the A/C and stop the vehicle in a safe area to cool down the engine.***
- ***When towing check transaxle fluid more frequently.***
- ***If your vehicle is not equipped with the air conditioner, you should install a condenser fan to improve engine performance when towing a trailer.***

If you do decide to pull a trailer

Here are some important points if you decide to pull a trailer:

- State, provincial, county and municipal government have varying trailering laws. Make sure your hitch, mirrors, lights and wiring arrangements are legal, not only where you live, but also where you'll be driving. A good source for this information is provincial or local law enforcement agencies.
- Consider using a sway control. You can ask a hitch dealer about sway control.
- After your odometer indicates 800 km (500 miles) or more, you can tow a trailer. For the first 800 km (500 miles) that you tow a trailer, don't drive over 80 km/h (50 mph) and don't make starts at full throttle. This helps your engine and other parts of your vehicle "wear" in at the heavier loads.
- Always drive your vehicle at a moderate speed (less than 100 km/h (60 mph)).
- On a long uphill grade, do not exceed 70 km/h (45 mph) or the posted towing speed limit, whichever is lower.
- The important considerations have to do with weight:

Weight of the trailer

How heavy can a trailer safely be? It should never weigh more than the maximum trailer weight with trailer brakes. But even that can be too heavy.

It depends on how you plan to use your trailer. For example, speed, altitude, road grades, outside temperature and how much your vehicle is used to pull a trailer are all important. The ideal trailer weight can also depend on any special equipment that you have on your vehicle.

Weight of the trailer tongue

The tongue load of any trailer is an important weight to measure because it affects the total gross vehicle weight (GVW) of your vehicle. This weight includes the curb weight of the vehicle, any cargo you may carry in it, and the people who will be riding in the vehicle. And if you will tow a trailer, you must add the tongue load to the GVW because your vehicle will also be carrying that weight.

The trailer tongue should weigh a maximum of 10% of the total loaded trailer weight. After you've loaded your trailer, weigh the trailer and then the tongue, separately, to see if the weights are proper. If they aren't, you may be able to correct them simply by moving some items around in the trailer.

WARNING - Trailer

- Never load a trailer with more weight in the rear than in the front. The front should be loaded with approximately 60% of the total trailer load; the rear should be loaded with approximately 40% of the total trailer load.
- Never exceed the maximum weight limits of the trailer or trailer towing equipment. Improper loading can result in damage to your vehicle and/or personal injury. Check weights and loading at a commercial scale or highway patrol office equipped with scales.
- An improperly loaded trailer can cause loss of vehicle control.

OVERLOADING

WARNING - Vehicle weight

The gross axle weight rating (GAWR) and the gross vehicle weight rating (GVWR) for your vehicle are on the manufacturer's label attached to the driver's door. Exceeding these ratings can cause an accident or vehicle damage. You can calculate the weight of your load by weighing the items (and people) before putting them in the vehicle. Be careful not to overload your vehicle.

LABEL INFORMATION

There are several important labels and identification numbers located on your vehicle. The label locations are identified in the illustrations shown.

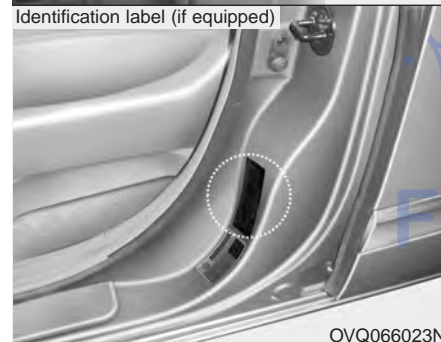
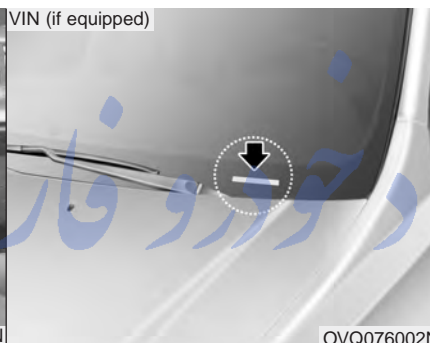
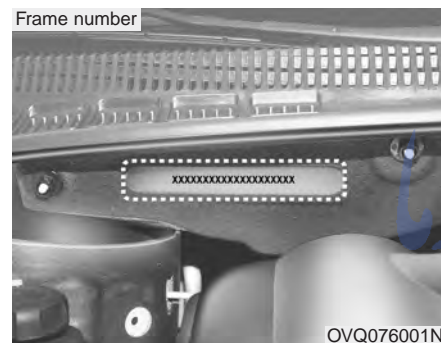

Vehicle identification number (VIN)

Road warning / 5-2
Emergency starting / 5-2
If the engine overheats / 5-5
If you have a flat tire / 5-6
Towing / 5-15

امداد خودرو فارما

۰۲۱-۸۸۸۶۷۰۸۵

What to do in an emergency

5

FarmaSOS.com

What to do in an emergency

ROAD WARNING

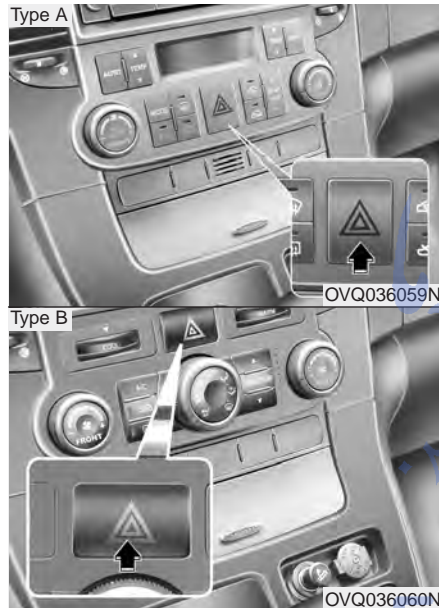

Hazard warning flasher

The hazard warning flasher serves as a warning to other drivers to exercise extreme caution when approaching, overtaking, or passing your vehicle.

It should be used whenever emergency repairs are being made or when the vehicle is stopped near the edge of a roadway.

Depress the flasher switch with the ignition switch in any position. The flasher switch is located in the center console switch panel. All turn signal lights will flash simultaneously.

- The hazard warning flasher operates whether your vehicle is running or not.
- The turn signals do not work when the hazard flasher is on.
- Care must be taken when using the hazard warning flasher while the vehicle is being towed.

EMERGENCY STARTING

Jump starting

Jump starting can be dangerous if done incorrectly. Therefore, to avoid harm to yourself or damage to your vehicle or battery, follow the jump starting procedures. If in doubt, we strongly recommend that you have a competent technician or towing service jump start your vehicle.

CAUTION

Use only a 12-volt jumper system. You can damage a 12-volt starting motor, ignition system, and other electrical parts beyond repair by use of a 24-volt power supply (either two 12-volt batteries in series or a 24-volt motor generator set).

⚠ WARNING - Battery
Never attempt to check the electrolyte level of the battery as this may cause the battery to rupture or explode causing serious injury.

⚠ WARNING - Battery

- Keep all flames or sparks away from the battery. The battery produces hydrogen gas which may explode if exposed to flame or sparks.
- Do not attempt to jump start the vehicle if the discharged battery is frozen or if the electrolyte level is low; the battery may rupture or explode.

Connecting jumper cables

Connect cables in numerical order and disconnect in reverse order.

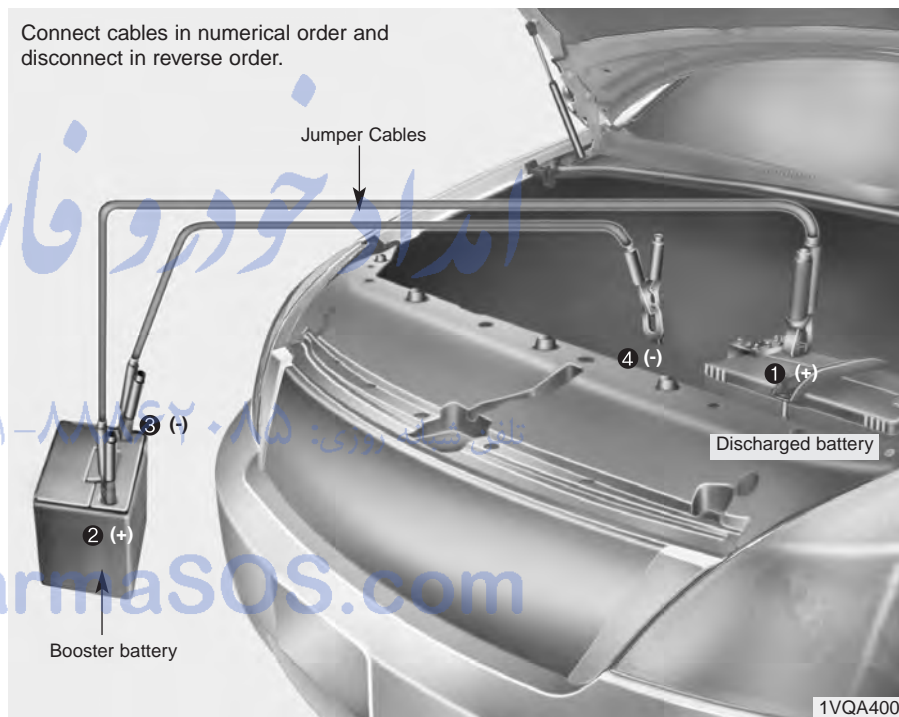

What to do in an emergency

Jump starting procedure

1. Make sure the booster battery is 12-volt and that its negative terminal is grounded.
2. If the booster battery is in another vehicle, do not allow the vehicles to touch.
3. Turn off all unnecessary electrical loads.
4. Connect the jumper cables in the exact sequence shown in the previous illustration. First connect one end of a jumper cable to the positive terminal of the discharged battery (1), then connect the other end to the positive terminal on the booster battery (2). Proceed to connect one end of the other jumper cable to the negative terminal of the booster battery (3), then the other end to a solid, stationary, metallic point (for example, the engine lifting bracket) away from the battery (4). Do not connect it to or near any part that moves when the engine is cranked.

⚠ CAUTION - Battery cables
Do not connect the jumper cable from the negative terminal of the booster battery to the negative terminal of the discharged battery. This can cause the discharged battery to overheat and crack, releasing battery acid.

Do not allow the jumper cables to contact anything except the correct battery terminals or the correct ground. Do not lean over the battery when making connections.

5. Start the engine of the vehicle with the booster battery and let it run at 2,000 rpm, then start the engine of the vehicle with the discharged battery.

If the cause of your battery discharging is not apparent, you should have your vehicle checked by an Authorized Kia Dealer.

Push-starting

Vehicles equipped with automatic transaxle cannot be push-started. Follow the directions in this section for jump-starting.

⚠ CAUTION
Never tow a vehicle to start it because the sudden surge forward when the engine starts could cause a collision with the tow vehicle.

IF THE ENGINE OVERHEATS

If your temperature gauge indicates overheating, if you experience a loss of power, or if you hear a loud knocking or pinging noise, the engine has probably overheated. Should any of these symptoms occur, use the following procedure:

1. Turn on the hazard warning flasher, then drive to the nearest safe location and stop your vehicle; set the automatic transaxle in P (Park) and apply the parking brake.
2. Make sure the air conditioner is off.
3. If coolant or steam is boiling out of the radiator, stop the engine and call an Authorized Kia Dealer for assistance. If coolant is not boiling out, allow the engine to idle and open the hood to permit the engine to cool gradually. If the temperature does not go down with the engine idling, stop the engine and allow sufficient time for it to cool.

4. The coolant level should then be checked. If the level in the reservoir is low, look for leaks at the radiator hoses and connections, heater hoses and connections, radiator, and water pump. If you find a major leak or another problem that may have caused the engine to overheat, do not operate the engine until it has been corrected. Call an Authorized Kia Dealer for assistance. If you do not find a leak or other problem, carefully add coolant to the reservoir.

If the engine frequently overheats, have the cooling system checked and repaired by an Authorized Kia Dealer.

⚠ WARNING - Removing radiator cap

Do not remove the radiator cap when the engine and radiator are hot. Scalding hot coolant and steam may blow out under pressure. This could cause serious injury.

تلفن شبانه روزی: ۰۸۵-۸۸۶۲۰۸۱-۲۱
FarmaSOS.com

What to do in an emergency

IF YOU HAVE A FLAT TIRE

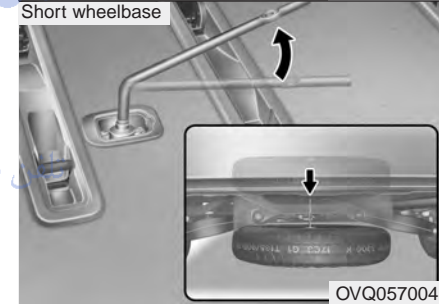
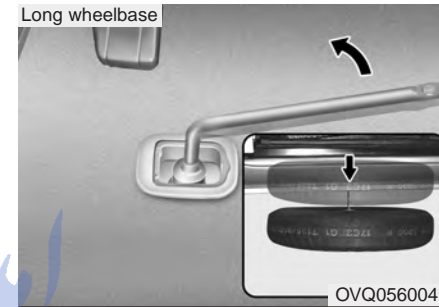
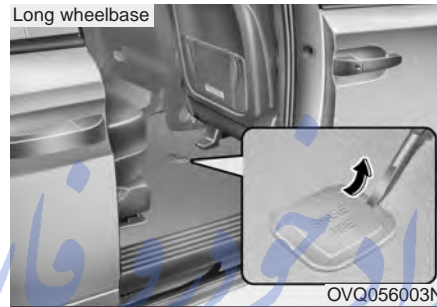

The jack, jack handle, wheel lug nut wrench are stored in the luggage compartment. Remove the panel indicated in the illustration.

Removing the spare tire

Your spare tire is stored underneath your vehicle, directly below the right sliding door (on the cargo).

1. Open the right sliding door (or the tailgate) and find the plastic hex bolt cover on the floor.
2. Remove the cover.

3. Use the wheel lug nut wrench to loosen the bolt enough to lower the spare tire.

Turn the wrench counterclockwise until the spare tire reaches the ground.

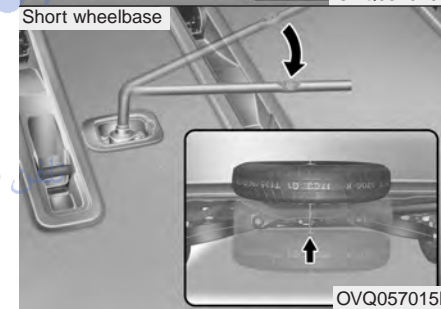
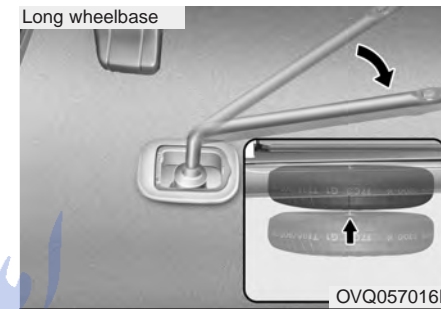
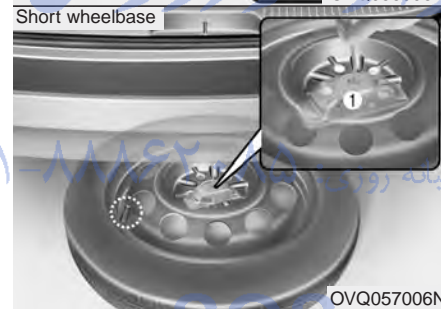
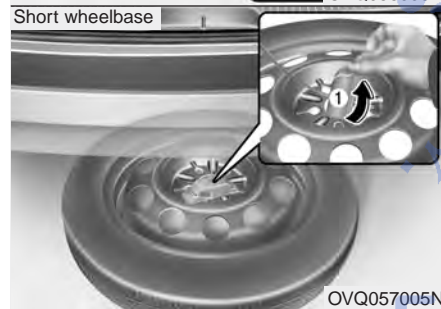
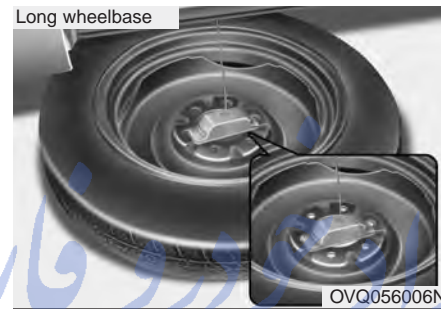
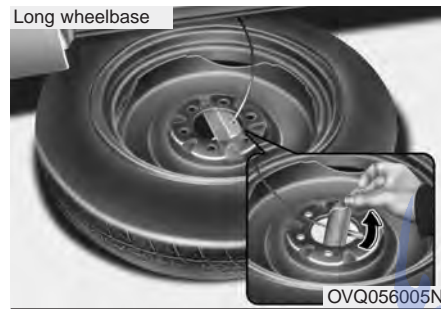

4. After the spare tire reaches the ground, continue to turn the wrench counterclockwise, and draw the spare tire outside. Never rotate the wrench excessively, otherwise the spare tire carrier may be damaged.

5. Remove the retainer from the center of the spare tire.

Storing the spare tire

1. Long wheelbase

Lay the tire on the ground with the valve stem facing down.

Short wheelbase

Lay the tire on the ground with the valve stem facing up.

2. Place the wheel under the vehicle and install the retainer through the wheel center.

3. Turn the wrench clockwise until it clicks.

⚠ WARNING

Ensure the spare tire retainer is properly aligned with the center of the spare tire to prevent the spare tire “rattling”. Otherwise, it may cause the spare tire to fall off the carrier and lead to an accident.

Important - use of compact spare tire

Your vehicle is equipped with a compact spare tire. This compact spare tire takes up less space than a regular-size tire. This tire is smaller than a conventional tire and is designed for temporary use only.

⚠ CAUTION

- *You should drive carefully when the compact spare is in use. The compact spare should be replaced by the proper conventional tire and rim at the first opportunity.*
- *The operation of this vehicle is not recommended with more than one compact spare tire in use at the same time.*

⚠ WARNING

This spare tire should be used only for VERY short distances. Compact spares should NEVER be used for long drives or extended distances.

The compact spare should be inflated to 420 kPa (60 psi).

*** NOTICE**

Check the inflation pressure after installing the spare tire. Adjust it to the specified pressure, as necessary.

When using a compact spare tire, observe the following precautions:

- Under no circumstances should you exceed 80 km/h (50 mph); a higher speed could damage the tire.
- Ensure that you drive slowly enough for the road conditions to avoid all hazards. Any road hazard, such as a pothole or debris, could seriously damage the compact spare.
- Any continuous road use of this tire could result in tire failure, loss of vehicle control, and possible personal injury.
- Do not exceed the vehicle's maximum load rating or the load-carrying capacity shown on the sidewall of the compact spare tire.
- Avoid driving over obstacles. The compact spare tire diameter is smaller than the diameter of a conventional tire and reduces the ground clearance approximately 25 mm (1 inch), which could result in damage to the vehicle.

- Do not take this vehicle through an automatic car wash while the compact spare tire is installed.
- Do not use tire chains on the compact spare tire. Because of the smaller size, a tire chain will not fit properly. This could damage the vehicle and result in loss of the chain.
- The compact spare tire should not be installed on the front axle if the vehicle must be driven in snow or on ice.
- Do not use the compact spare tire on any other vehicle because this tire has been designed especially for your vehicle.
- The compact spare tire's tread life is shorter than a regular tire. Inspect your compact spare tire regularly and replace worn compact spare tires with the same size and design, mounted on the same wheel.



Changing tires

Jacking instructions

The jack is provided for emergency tire changing only.

To prevent the jack from “rattling” while the vehicle is in motion, lower the jack to the lowest position, place the jack in the luggage side trim and turn the wing bolt (1) clockwise firmly. Make sure the jack is secured firmly by trying to move the jack forward and backward.

Follow jacking instructions to reduce the possibility of personal injury.

⚠ WARNING - Changing tires

- Never attempt vehicle repairs in the traffic lanes of a public road or highway.
 - Always move the vehicle completely off the road and onto the shoulder before trying to change a tire. The jack should be used on level firm ground. If you cannot find a firm, level place off the road, call a towing service company for assistance.
 - Be sure to use the correct front and rear jacking positions on the vehicle; never use the bumpers or any other part of the vehicle for jack support.
- (Continued)

What to do in an emergency

(Continued)

- The vehicle can easily roll off the jack causing serious injury or death. No person should place any portion of their body under a vehicle that is supported only by a jack; use vehicle support stands.
- Do not start or run the engine while the vehicle is on the jack.
- Do not allow anyone to remain in the vehicle while it is on the jack.
- Make sure any children present are in a secure place away from the road and from the vehicle to be raised with the jack.

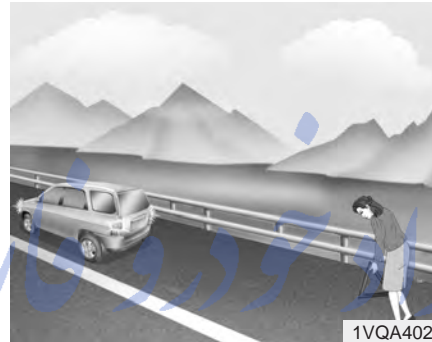

Tire replacement

1. Park on a level surface and apply the parking brake firmly.
2. Shift the shift lever into P (Park) with automatic transaxle.
3. Activate the hazard warning flasher.



4. Remove the wheel lug nut wrench, jack, jack handle, and spare tire from the vehicle.
5. Block both the front and rear of the wheel that is diagonally opposite the jack position.

FarmaSOS.com

⚠ WARNING - Changing a tire

- To prevent vehicle movement while changing a tire, always set the parking brake fully, and always block the wheel diagonally opposite the wheel being changed.
- We recommend that the wheels of the vehicle be chocked, and that no person remain in a vehicle that is being jacked.



6. Loosen the wheel lug nuts counterclockwise one turn each, but do not remove any nut until the tire has been raised off the ground.



7. Place the jack at the front or rear jacking position closest to the tire you are changing. Place the jack at the designated locations under the frame. The jacking positions are plates welded to the frame with two tabs and a raised dot to index with the jack.

FarmaSOS.com

⚠ WARNING - Jack location

To reduce the possibility of injury, be sure to use only the jack provided with the vehicle and in the correct jack position; never use any other part of the vehicle for jack support.

What to do in an emergency



8. Insert the jack handle into the jack and turn it clockwise, raising the vehicle until the tire just clears the ground. This measurement is approximately 30 mm (1.2 in). Before removing the wheel lug nuts, make sure the vehicle is stable and that there is no chance for movement or slippage.
9. Remove the wheel lug nuts by turning them counterclockwise, then remove the wheel.
10. Mount the spare tire into position and install the wheel lug nuts with the beveled edge inward.



11. Once the wheel lug nuts have been tightened, lower the vehicle fully to the ground and continue to tighten the lug nuts until they are fully secured. Tighten the wheel lug nuts firmly in a “×” pattern.
If you are unsure of the tightness of the wheel lug nuts, have them checked at the nearest service station. The specified tightening torque is 9~11 kg•m (65-79 lb•ft, 88-107 N•m). Improperly tightened wheel lug nuts could cause brake pedal vibration while braking.

CAUTION

Your vehicle has metric threads on the wheel studs and nuts. Make certain during wheel removal that the same nuts removed are reinstalled - or, if replaced, that nuts with metric threads and the same chamfer configuration are used. Installation of a non-metric thread nut on a metric stud or vice-versa will not secure the wheel to the hub properly and will damage the stud so that it must be replaced.

Note that most lug nuts do not have metric threads. Be sure to use extreme care in checking for thread style before installing aftermarket lug nuts or wheels. If in doubt, consult an Authorized Kia Dealer.

⚠ WARNING - Wheel studs
If the studs are damaged, they may lose their ability to retain the wheel. This could lead to the loss of the wheel and a collision resulting in serious injuries.

To prevent the jack, jack handle, wheel lug nut wrench and spare tire from rattling while the vehicle is in motion, store them properly.

⚠ WARNING - Inadequate spare tire pressure
Check the inflation pressures as soon as possible after installing the spare tire. Adjust it to the specified pressure, if necessary. Refer to Section 8, Specifications.

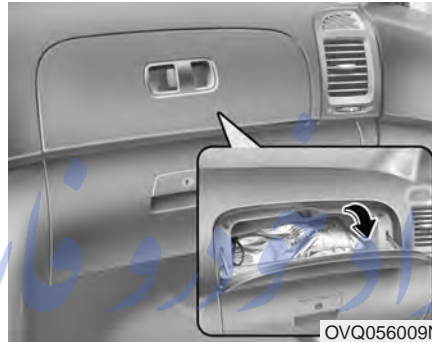

Carrying a flat tire (Long wheelbase)

Do not store the flat tire on the compact spare tire carrier underneath your vehicle. The full size flat tire should be stored and fixed in the vehicle until you reach a service station.

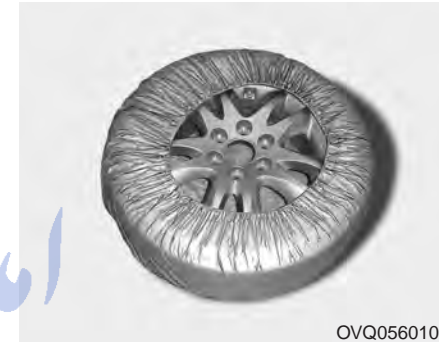

To place a flat tire in the vehicle:

1. Wrap the flat tire with the cover with the valve stem facing up.

PharmaSOS.com

What to do in an emergency



2. Place the flat tire in the cargo area when the 3rd row seat is upright position or on the floor when the 3rd row seat is stowed in the cargo area.

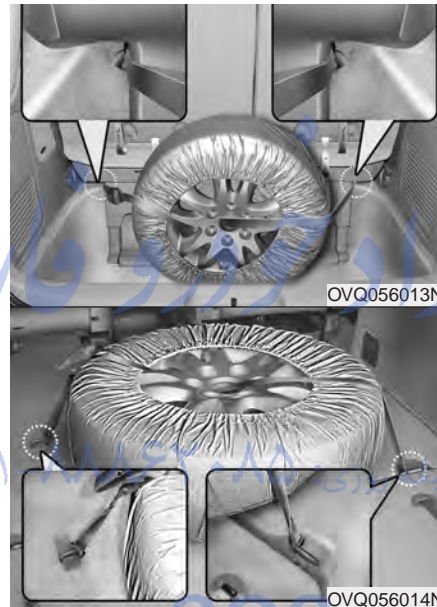

3. If necessary, connect the two straps with the buckle.

Pass one end of the strap through the wheel center and connect both strap hooks to each striker of the 3rd row seat on the floor.

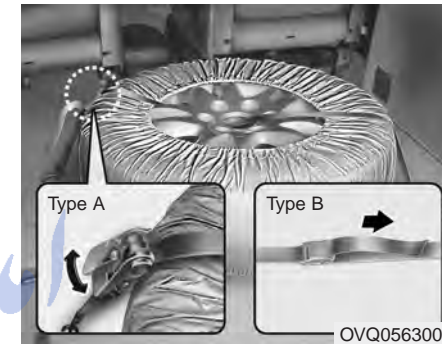

4. **Type A** : Tighten the strap firmly using the ratchet.

Type B : Tighten the strap firmly pulling the strap out of the buckle.

5. Make sure the flat tire is properly secured by trying to move it.

⚠ WARNING - Flat tire

Never leave the flat tire unfixed in the vehicle to prevent the tire "rattling". Otherwise, the unsecured flat tire may be thrown about inside the vehicle which can cause damage to the vehicle and serious injury or death to the vehicle occupants in case of a sharp turn, a sudden stop or an accident.

TOWING

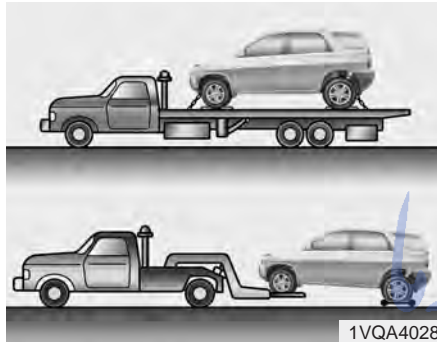

If emergency towing is necessary, we recommend having it done by an authorized Kia dealer or a commercial tow-truck service. Proper lifting and towing procedures are necessary to prevent damage to the vehicle. The use of wheel dollies or flatbed is recommended.

For trailer towing guidelines information, refer to section 4 "Driving your vehicle".

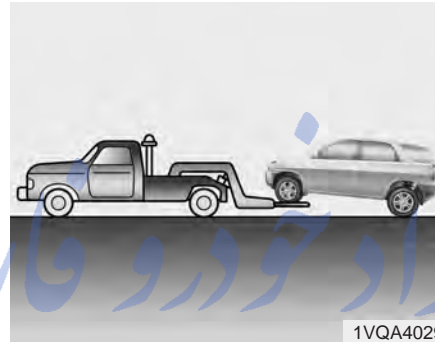

It is acceptable to tow the vehicle with the rear wheels on the ground (without dollies) and the front wheels off the ground. When being towed by a commercial tow truck and wheel dollies are not used, the front of the vehicle should always be lifted, not the rear.

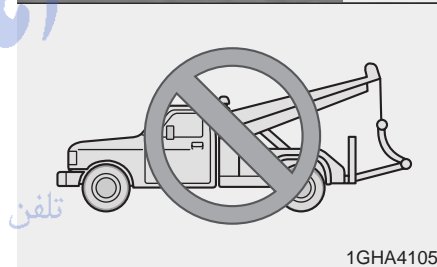

CAUTION

- **Do not tow the vehicle backwards with the front wheels on the ground as this may cause damage to the vehicle.**
- **Do not tow with sling-type equipment. Use wheel lift or flatbed equipment.**

What to do in an emergency

When towing your vehicle in an emergency without wheel dollies :

1. Set the ignition switch in the ACC position.
2. Place the transaxle shift lever in N (Neutral).
3. Release the parking brake.

CAUTION

Failure to place the transaxle shift lever in N (Neutral) may cause internal damage to the transaxle.

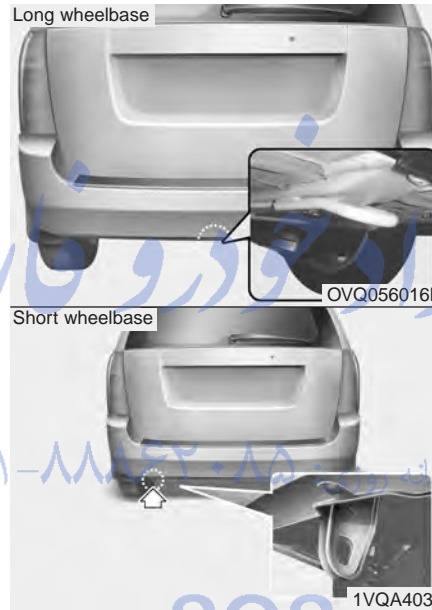

If your car must be towed
Towing with a vehicle other than a tow truck

If towing is necessary, we recommend you to have it done by an Authorized Kia dealer or a commercial tow truck service.

If towing service is not available in an emergency, your vehicle may be temporarily towed using a cable or chain secured to the emergency towing hook under the rear of the vehicle. Use extreme caution when towing the vehicle. A driver must be in the vehicle to steer it and operate the brakes.

Towing in this manner may be done only on hard-surfaced roads for a short distance and at low speeds. Also, the wheels, axles, power train, steering and brakes must all be in good condition.

- Do not use the tow hooks to pull a vehicle out of mud, sand or other conditions from which the vehicle cannot be driven out under its own power.
- Avoid towing a vehicle heavier than the vehicle doing the towing.
- The drivers of both vehicles should communicate with each other frequently.

CAUTION

- *Attach a towing strap to the tow hook.*
- *Using a portion of the vehicle other than the tow hooks for towing may damage the body of your vehicle.*
- *Use only a cable or chain specifically intended for use in towing vehicles. Securely fasten the cable or chain to the towing hook provided.*

- Before emergency towing, check that the hook is not broken or damaged.
- Fasten the towing cable or chain securely to the hook.
- Do not jerk the hook. Apply steady and even force.
- To avoid damaging the hook, do not pull from the side or at a vertical angle. Always pull straight ahead.

WARNING

Use extreme caution when towing the vehicle.

- Avoid sudden starts or erratic driving maneuvers which would place excessive stress on the emergency towing hook and towing cable or chain. The hook and towing cable or chain may break and cause serious injury or damage.
- If the disable vehicle is unable to be moved, do not forcibly continue the towing. Contact an Authorized Kia dealer or a commercial tow truck service for assistance.
- Tow the vehicle as straight ahead as possible.
- Keep away from the vehicle during towing.

CAUTION

To prevent internal damage to the transaxle, never tow your vehicle from the rear (backwards) with all four tires in contact with the surface.

What to do in an emergency

Tips for towing a stuck vehicle

The following methods are effective when your vehicle is stuck in mud, sand or similar substances that prevent the vehicle from being driven out under its own power.

- Remove the soil and sand, etc. from the front and the back of the tires.
- Place a stone or wood under the tires.



**Tie-down hook
(for flatbed towing)**

⚠ WARNING

Do not use the hooks under the front of the vehicle for towing purposes. These hooks are designed **ONLY** for transport tie-down. If the tie-down hooks are used for towing, the tie-down hooks or front bumper will be damaged and this could lead to serious injury.

Maintenance services / 6-2
Maintenance schedule / 6-3
Owner maintenance / 6-7
Engine compartment / 6-9
Engine oil / 6-10
Engine coolant / 6-11
Air cleaner / 6-13
Automatic transaxle / 6-13
Brakes / 6-15
Lubricants and fluids / 6-16
Power steering / 6-17
Climate control air filter / 6-17
Wiper blades / 6-18
Fuses / 6-20
Battery / 6-28

Maintenance

6

Tires and wheels / 6-30
Lubricant / 6-42
Appearance care / 6-43
Emission control system / 6-46

Maintenance

MAINTENANCE SERVICES

You should exercise the utmost care to prevent damage to your vehicle and injury to yourself whenever performing any maintenance or inspection procedures.

Should you have any doubts concerning the inspection or servicing of your vehicle, we strongly recommend that you have an Authorized Kia Dealer perform this work.

An Authorized Kia Dealer has factory-trained technicians and genuine Kia parts to service your vehicle properly. For expert advice and quality service, see an Authorized Kia Dealer.

Inadequate, incomplete or insufficient servicing may result in operational problems with your vehicle that could lead to vehicle damage, an accident, or personal injury.

Owner's responsibility

Maintenance Service and Record Retention are the owner's responsibility.

You should retain documents that show proper maintenance has been performed on your vehicle in accordance with the scheduled maintenance service charts shown on the following pages. You need this information to establish your compliance with the servicing and maintenance requirements of your Kia warranties.

Detailed warranty information is provided in your Warranty & Consumer Information manual.

Repairs and adjustments required as a result of improper maintenance or a lack of required maintenance are not covered.

We strongly recommend that all vehicle maintenance be performed by an authorized Kia dealer using genuine Kia parts.

FarmaSOS.com

MAINTENANCE SCHEDULE**Engine control system**

MAINTENANCE ITEM	MAINTENANCE INTERVALS	Kilometers or time in months, whichever comes first																
		× 1,000 km	8	16	24	32	40	48	56	64	72	80	88	96	104	112	120	128
		# Months	4	8	12	16	20	24	28	32	36	40	44	48	52	56	60	64
Engine oil & engine oil filter	(1)	R	R	R	R	R	R	R	R	R	R	R	R	R	R	R	R	R
Drive belts (tension)					I				I				I					I
Cooling system hoses & connections				I				I		I			I				I	
Engine coolant	(1)	I	I	I	I	I	R	I	I	I	I	I	R	I	I	I	I	I
Fuel filter								R							R			
Fuel tank cap, lines, EVAP canister and hoses							I						I					
Fuel tank air filter				I			R			I			R				I	
Air cleaner element	(2)	I	I	I	I	I	R	I	I	I	I	I	R	I	I	I	I	I
Ignition wires							I						I					
Spark plugs		Replace every 160,000 km																
PCV valve (if equipped)					I				I				I					I
Idle speed				I			I		I				I				I	
Valve clearance	(3)												I					

Maintenance

MAINTENANCE SCHEDULE (CONTINUED)

Chassis and body

MAINTENANCE ITEM	MAINTENANCE INTERVALS	Kilometers or time in months, whichever comes first																
		× 1,000 km	8	16	24	32	40	48	56	64	72	80	88	96	104	112	120	128
		# Months	4	8	12	16	20	24	28	32	36	40	44	48	52	56	60	64
Air conditioner compressor operation & refrigerant amount (if equipped)																		
Exhaust pipes, heat shield & mountings																		
Front suspension ball joints																		
Brakes fluid (1)									R								R	
Front brake pads & discs (4)																		
Rear brake pads & discs (4)																		
Parking brake																		
Brake lines & connections (including booster)																		
Brake pedal free play																		

FarmaSOS.com

MAINTENANCE SCHEDULE (CONTINUED)

Chassis and body (Continued)

MAINTENANCE ITEM	MAINTENANCE INTERVALS	Kilometers or time in months, whichever comes first																
		× 1,000 km	8	16	24	32	40	48	56	64	72	80	88	96	104	112	120	128
		# Months	4	8	12	16	20	24	28	32	36	40	44	48	52	56	60	64
Automatic transaxle fluid	(1)	I	I	I	R	I	I	I	R	I	I	I	R	I	I	I	R	
Chassis & underbody bolts & nuts		I	I	I	I	I	I	I	I	I	I	I	I	I	I	I	I	
Tire condition & inflation pressure		I	I	I	I	I	I	I	I	I	I	I	I	I	I	I	I	
Wheel alignment	(5)	Inspect when abnormal condition noted																
Tire rotation		Rotate the tires every 12,000 km																
Steering operation & linkage		I	I	I	I	I	I	I	I	I	I	I	I	I	I	I	I	
Power steering fluid & lines			I	I	I	I	I	I	I	I	I	I	I	I	I	I	I	
Driveshaft dust boots													I				I	
Safety belts, buckles & anchors		I	I	I	I	I	I	I	I	I	I	I	I	I	I	I	I	
Lock, hinges & hood latch		L	L	L	L	L	L	L	L	L	L	L	L	L	L	L	L	

FarmaSOS.com

Maintenance

Chart symbols:

I- Inspect these items and their related parts. If necessary, correct, clean, refill, adjust or replace.

R- Replace or change

L- Lubricate.

- (1) Refer to the lubricant and coolant specifications in the Owner's Manual
- (2) More frequent maintenance is required if driving under dusty conditions.
- (3) Inspect excessive valve noise and/or engine vibration and adjust if necessary. A qualified technician should perform the operation.
- (4) More frequent maintenance is required if the vehicle is operated under any of the following conditions:
 - a. Short-distance driving
 - b. Driving on dusty roads.
 - c. Extensive idling or slow-speed driving in stop-and-go traffic.
- (5) If necessary, rotate and balance the wheels.

* Note: Check the engine oil and coolant levels every week.

تلفن شبانه روزی: ۰۲۱-۸۸۸۶۲۰۸۵

FarmaSOS.com

OWNER MAINTENANCE

Owner maintenance schedule

The following lists are vehicle checks and inspections that should be performed by the owner or an Authorized Kia Dealer at the frequencies indicated to help ensure safe, dependable operation of your vehicle.

Any adverse conditions should be brought to the attention of your dealer as soon as possible.

These Owner Maintenance Checks are generally not covered by warranties and you may be charged for labor, parts and lubricants used.

When you stop for fuel:

- Check the engine oil level.
- Check coolant level in coolant reservoir.

⚠ WARNING

Be careful when checking your engine coolant level when the engine is hot. Scalding hot coolant and steam may blow out under pressure. This could cause burns or other serious injury.

- Check the windshield washer fluid level.
- Look for low or under-inflated tires.

While operating your vehicle:

- Note any changes in the sound of the exhaust or any smell of exhaust fumes in the vehicle.
- Check for vibrations in the steering wheel. Notice any increased steering effort or looseness in the steering wheel, or change in its straight-ahead position.
- Notice if your vehicle constantly turns slightly or “pulls” to one side when traveling on smooth, level road.
- When stopping, listen and check for unusual sounds, pulling to one side, increased brake pedal travel or “hard-to-push” brake pedal.
- If any slipping or changes in the operation of your transaxle occurs, check the transaxle fluid level.
- Check automatic transaxle P (Park) function.
- Check parking brake.
- Check for fluid leaks under your vehicle (water dripping from the air conditioning system during or after use is normal).

At least monthly:

- Check coolant level in the coolant recovery reservoir.
- Check the operation of all exterior lights, including the stoplights, turn signals and hazard warning flashers.
- Check the inflation pressures of all tires including the spare.

At least twice a year (i.e., every Spring and Fall):

- Check radiator, heater and air conditioning hoses for leaks or damage.
- Check windshield washer spray and wiper operation. Clean wiper blades with clean cloth dampened with washer fluid.
- Check headlight alignment.
- Check muffler, exhaust pipes, shields and clamps.
- Check the lap/shoulder belts for wear and function.
- Check for worn tires and loose wheel lug nuts.

Maintenance

At least once a year:

- Clean body and door drain holes.
- Lubricate door hinges and checks, and hood hinges.
- Lubricate door and hood locks and latches.
- Lubricate door rubber weatherstrips.
- Check the air conditioning system before the warm weather season.
- Check the power steering fluid level.
- Inspect and lubricate automatic transaxle linkage and controls.
- Clean battery and terminals.
- Check the brake fluid level.

Owner maintenance precautions

Improper or incomplete service may result in problems. This section gives instructions only for the maintenance items that are easy to perform.

As explained earlier in this section, several procedures can be done only by an Authorized Kia Dealer with special tools.

Improper owner maintenance during the warranty period may affect warranty coverage. For details, read the separate Kia Warranty & Consumer Information Manual provided with the vehicle. If you're unsure about any servicing or maintenance procedure, have it done by an Authorized Kia Dealer.

⚠ WARNING - Maintenance work

- **Performing maintenance work on a vehicle can be dangerous. You can be seriously injured while performing some maintenance procedures. If you lack sufficient knowledge and experience or the proper tools and equipment to do the work, have it done by an Authorized Kia Dealer.**
- **Working under the hood with the engine running is dangerous. It becomes even more dangerous when you wear jewelry or loose clothing. These can become entangled in moving parts and result in injury. Always remove all loose or hanging clothing and all jewelry before working on the engine.**

FarmaSOS.com

ENGINE COMPARTMENT

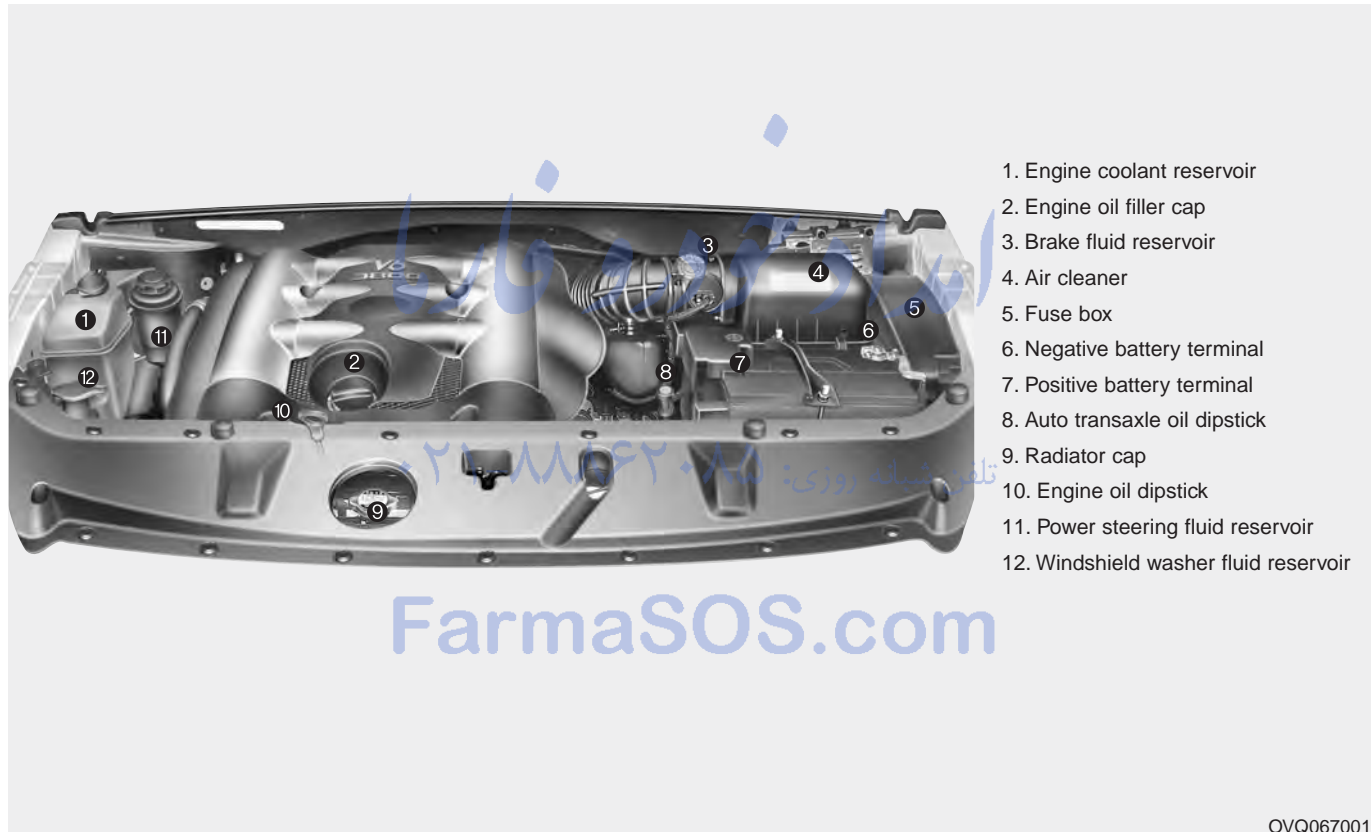

1. Engine coolant reservoir
2. Engine oil filler cap
3. Brake fluid reservoir
4. Air cleaner
5. Fuse box
6. Negative battery terminal
7. Positive battery terminal
8. Auto transaxle oil dipstick
9. Radiator cap
10. Engine oil dipstick
11. Power steering fluid reservoir
12. Windshield washer fluid reservoir

OVQ067001N

ENGINE OIL



Checking the engine oil level

1. Be sure the vehicle is on level ground.
2. Start the engine and allow it to reach normal operating temperature.
3. Turn the engine off and wait for a few minutes (about 5 minutes) for the oil to return to the oil pan.
4. Pull the dipstick out, wipe it clean, and re-insert it fully.

⚠ WARNING - Radiator hose
Be very careful not to touch the radiator hose when checking or adding the engine oil as it may be hot enough to burn you.

5. Pull the dipstick out again and check the level. The level should be between F and L.

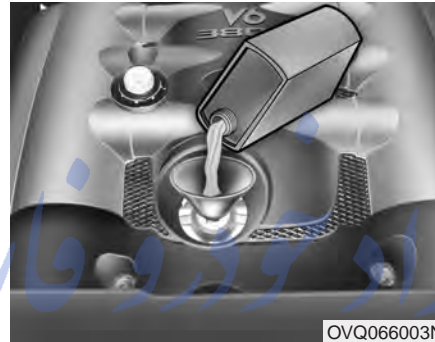

If it is near or at L, add enough oil to bring the level to F. **Do not overfill.**

Use a funnel to refill the new oil comfortably.

Use only the specified engine oil. (Refer to "Recommended Lubricants" later in this section.)

Have engine oil and filter changed by an Authorized Kia Dealer according to the Maintenance Schedule at the beginning of this section.

⚠ WARNING

Used engine oil may cause irritation or cancer of the skin if left in contact with the skin for prolonged periods of time. Used engine oil contains chemicals that have caused cancer in laboratory animals. Always protect your skin by washing your hands thoroughly with soap and warm water as soon as possible after handling used oil.

ENGINE COOLANT

The high-pressure cooling system has a reservoir filled with year-round antifreeze coolant. The reservoir is filled at the factory.

Check the antifreeze protection and coolant level at least once a year, at the beginning of the winter season, and before traveling to a colder climate.

Checking the coolant level

⚠ WARNING - Removing radiator cap

- Never attempt to remove the radiator cap while the engine is operating or hot. Doing so might lead to cooling system and engine damage and could result in serious personal injury from escaping hot coolant or steam.

(Continued)

(Continued)

- Turn the engine off and wait until it cools down. Use extreme care when removing the radiator cap. Wrap a thick towel around it, and turn it counterclockwise slowly to the first stop. Step back while the pressure is released from the cooling system. When you are sure all the pressure has been released, press down on the cap, using a thick towel, and continue turning counterclockwise to remove it.
- Even if the engine is not operating, do not remove the radiator cap or the drain plug while the engine and radiator are hot. Hot coolant and steam may still blow out under pressure, causing serious injury.



Check the condition and connections of all cooling system hoses and heater hoses. Replace any swollen or deteriorated hoses.

Maintenance



The coolant level should be filled between F and L marks on the side of the coolant reservoir when the engine is cool.

If the coolant level is low, add enough specified coolant to provide protection against freezing and corrosion. Bring the level to F, but do not overfill. If frequent additions are required, see an Authorized Kia Dealer for a cooling system inspection.

Have coolant changed by an Authorized Kia Dealer according to the Maintenance Schedule at the beginning of this section.

- Use only soft (de-mineralized) water in the coolant mixture.
- The engine in your vehicle has aluminum engine parts and must be protected by an ethylene-glycol-based coolant to prevent corrosion and freezing.
- DO NOT USE alcohol or methanol coolant or mix them with the specified coolant.
- Do not use a solution that contains more than 60% antifreeze or less than 35% antifreeze, which would reduce the effectiveness of the solution.

For mixture percentage, refer to the following table.

Ambient Temperature	Mixture Percentage (volume)	
	Coolant Solution	Water
-15°C (5°F)	35	65
-25°C (-13°F)	40	60
-35°C (-31°F)	50	50
-45°C (-49°F)	60	40

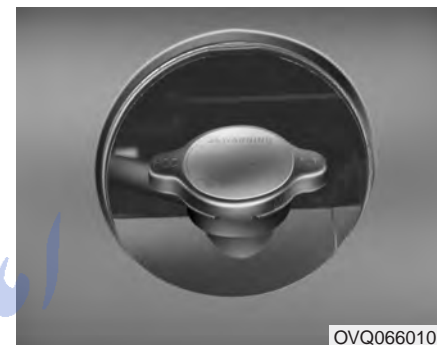

⚠ WARNING - Radiator cap
Do not remove the radiator cap when the engine and radiator are hot. Scalding hot coolant and steam may blow out under pressure causing serious injury.

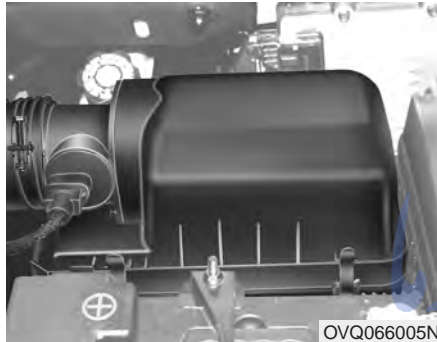
AIR CLEANER**Element replacement**

Have the air cleaner element checked and replaced in accordance with the maintenance schedule.

CAUTION - Engine

Do not drive with the air cleaner removed; this will result in excessive engine wear.

WARNING - Engine

Driving without an air cleaner encourages backfiring, which could cause a fire in the engine compartment.

AUTOMATIC TRANSAXLE**Checking the automatic transaxle fluid level**

The automatic transaxle fluid level should be checked regularly.

Keep the vehicle on the level ground with the parking brake applied and check the fluid level according to the following procedure.

1. Place the selector lever in N (Neutral) position and confirm the engine is running at normal idle speed.
2. After the transaxle is warmed up sufficiently (fluid temperature 70~80°C (158~176°F)), for example by 10 minutes usual driving, shift the selector lever through all positions then place the selector lever in N (Neutral) or P (Park) position.

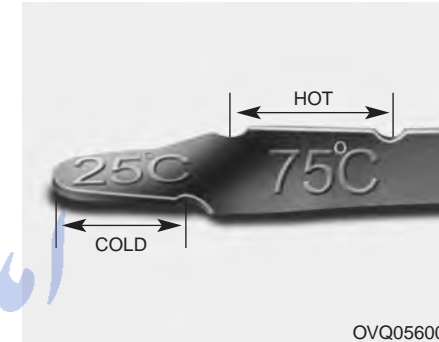

3. Confirm that the fluid level is in "HOT" range on the level gauge. If the fluid level is lower, add the specified fluid from the fill hole. If the fluid level is higher, drain the fluid from the drain hole.
4. If the fluid level is checked in cold condition (fluid temperature 20~30°C (68~86°F) add the fluid to "COLD" line and then recheck the fluid level according to the above step 2.

⚠ WARNING - Transaxle fluid
The transaxle fluid level should be checked when the engine is at normal operating temperature. This means that the engine, radiator, radiator hose and exhaust system etc., are very hot. Exercise great care not to burn yourself during this procedure.

⚠ CAUTION

- *Low fluid level causes transaxle slippage. Overfilling can cause foaming, loss of fluid and transaxle malfunction.*
- *The use of a non-specified fluid could result in transaxle malfunction and failure.*

⚠ WARNING - Parking brake
To avoid sudden movement of the vehicle, apply parking brake and depress the brake pedal before moving the shift lever.

“COLD” scale is for reference only and should NOT be used to determine transaxle fluid level.

New automatic transaxle fluid should be red. The red dye is added so the assembly plant can identify it as automatic transaxle fluid and distinguish it from engine oil or antifreeze. The red dye, which is not an indicator of fluid quality, is not permanent. As the vehicle is driven, the automatic transaxle fluid will begin to look darker. The color may eventually appear light brown.

*** NOTICE**

Have an Authorized Kia dealer change the automatic transaxle fluid according to the Scheduled Maintenance at the beginning of this section.

Use only the specified automatic transaxle fluid. (Refer to "Recommended Lubricants" later in this section.)

BRAKES

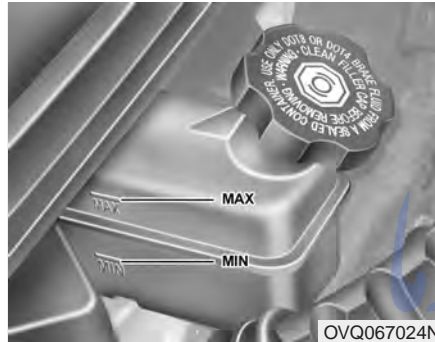

Checking brake fluid level

Check the fluid level in the reservoir periodically. The fluid level should be between MAX and MIN marks on the side of the reservoir.

Before removing the reservoir cap and adding brake fluid, clean the area around the reservoir cap thoroughly to prevent brake fluid contamination.

If the level is low, add fluid to the MAX level. The level will fall with accumulated mileage. This is a normal condition associated with the wear of the brake linings. If the fluid level is excessively low, have the brake system checked by an Authorized Kia Dealer.

Use only the specified brake fluid. (Refer to "Recommended Lubricants" later in this section.)

Never mix different types of fluid.

⚠ WARNING - Loss of brake fluid

In the event the brake system requires frequent additions of fluid, the vehicle should be inspected by an Authorized Kia Dealer.

⚠ WARNING - Brake fluid

When changing and adding brake fluid, handle it carefully. Do not let it come in contact with your eyes. If brake fluid should come in contact with your eyes, immediately flush them with a large quantity of fresh tap water. Have your eyes examined by a doctor as soon as possible.

⚠ CAUTION

Do not allow brake fluid to contact the vehicle's body paint, as paint damage will result. Brake fluid, which has been exposed to open air for an extended time should never be used as its quality cannot be guaranteed. It should be thrown out. Don't put in the wrong kind of fluid. A few drops of mineral-based oil, such as engine oil, in your brake system can damage brake system parts.

LUBRICANTS AND FLUIDS



Checking the washer fluid level

The reservoir is translucent so that you can check the level with a quick visual inspection.

Check the fluid level in the washer fluid reservoir and add fluid if necessary. Plain water may be used if washer fluid is not available. However, use washer solvent with antifreeze characteristics in cold climates to prevent freezing.



This warning light indicates the washer fluid reservoir is near empty. Refill the washer fluid as soon as possible.

⚠ WARNING - Coolant

- Do not use radiator coolant or antifreeze in the washer fluid reservoir.
- Radiator coolant can severely obscure visibility when sprayed on the windshield and may cause loss of vehicle control or damage to paint and body trim.
- Windshield washer fluid agents contain some amounts of alcohol and can be flammable under certain circumstances. Do not allow sparks or flame to contact the washer fluid or the washer fluid reservoir. Damage to the vehicle or it's occupants could occur.
- Windshield washer fluid is poisonous to humans and animals. Do not drink and avoid contacting windshield washer fluid. Serious injury or death could occur.

Body lubrication

All moving points of the body, such as door hinges, hood hinges, and locks, should be lubricated each time the engine oil is changed. Use a non-freezing lubricant on locks during cold weather.

Make sure the engine hood secondary latch keeps the hood from opening when the primary latch is released.

POWER STEERING



Checking the power steering fluid level

With the vehicle on level ground, check the fluid level in the power steering reservoir periodically. The fluid should be between MAX and MIN marks on the side of the reservoir at the normal temperature.

Before adding power steering fluid, thoroughly clean the area around the reservoir cap to prevent power steering fluid contamination.

If the level is low, add fluid to the MAX level.

In the event the power steering system requires frequent addition of fluid, the vehicle should be inspected by an Authorized Kia Dealer.

CAUTION

- To avoid damage to the power steering pump, do not operate the vehicle for prolonged periods with a low power steering fluid level.
- Never start the engine when the reservoir tank is empty.
- When adding fluid, be careful that dirt does not get into the tank.
- Too little fluid can result in increased steering effort and/or noise from the power steering system.
- The use of the non-specified fluid could reduce the effectiveness of the power steering system and cause damage to it.

Use only the specified power steering fluid. (Refer to "Recommended Lubricants" later in this section.)

Power steering hoses

Check the connections for oil leaks, severe damage and twists in the power steering hose before driving.

CLIMATE CONTROL AIR FILTER

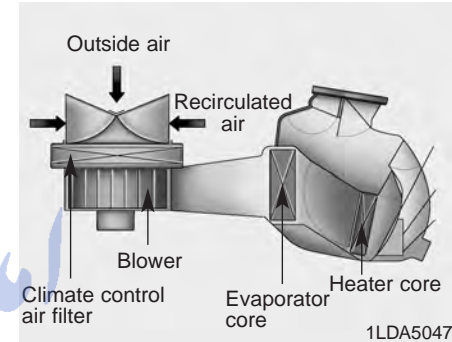

The climate control air filter installed behind the glove box filters the dust or other pollutants that come into the vehicle from the outside through the heating and air conditioning system. If dust or other pollutants accumulate in the filter over a period of time, the air flow from the air vents may decrease, resulting in moisture accumulation on the inside of the windshield even when the outside (fresh) air position is selected. If this happens, have the climate control air filter replaced by an Authorized Kia Dealer.

The climate control air filter should be replaced every 15,000 km (10,000 miles). If the vehicle is operated in the severely air-polluted cities or on dusty rough roads for a long period, it should be inspected more frequently and replaced earlier. When you try to replace the climate control air filter by owner maintenance, replace it performing the following procedure, and in this case, be careful to avoid damaging other components.

WIPER BLADES



Maintenance

Commercial hot waxes applied by automatic car washes have been known to make the windshield difficult to clean.

Contamination of either the windshield or the wiper blades with foreign matter can reduce the effectiveness of the windshield wipers. Common sources of contamination are insects, tree sap, and hot wax treatments used by some commercial car washes. If the blades are not wiping properly, clean both the window and the blades with a good cleaner or mild detergent, and rinse thoroughly with clean water.

CAUTION

To prevent damage to the wiper blades, do not use gasoline, kerosene, paint thinner, or other solvents on or near them.

Replacement

When the wipers no longer clean adequately, the blades may be worn or cracked, and require replacement.

CAUTION

To prevent damage to the wiper arms or other components, do not attempt to move the wipers manually.

CAUTION

The use of a non-specified wiper blade could result in wiper malfunction and failure.

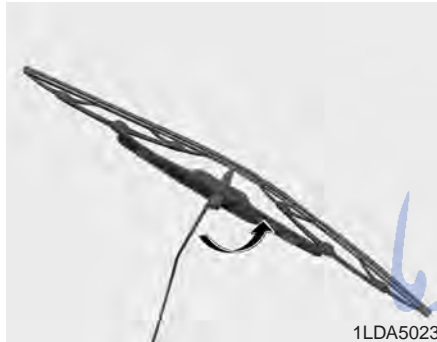

1LDA5023

Front windshield wiper blade

1. Raise the wiper arm and turn the wiper blade assembly to expose the plastic locking clip.

CAUTION

Do not allow the wiper arm to fall against the windshield, since it may chip or crack the windshield.

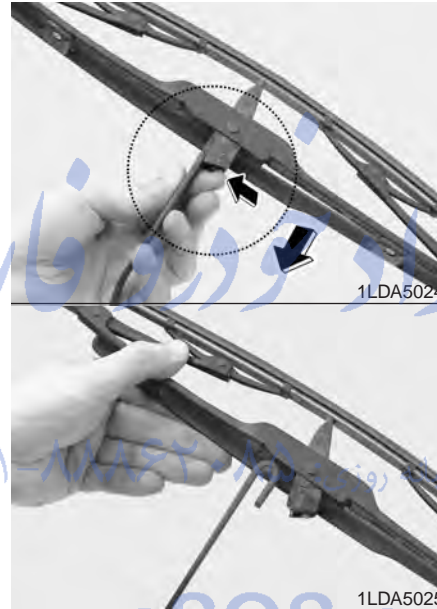

1LDA5024

1LDA5025

Rear window wiper blade replacement

To prevent damage to the wiper arms or other components, have an authorized Kia dealer replace the wiper blade.

2. Compress the clip and slide the blade assembly downward.
3. Lift it off the arm.
4. Install the blade assembly in the reverse order of removal.

FUSES

Blade type



A vehicle's electrical system is protected from electrical overload damage by fuses.

This vehicle has three fuse panels, one located in the driver's side panel bolster, another in the cargo area, the other in the engine compartment near the battery.

If any of your vehicle's lights, accessories, or controls do not work, check the appropriate circuit fuse. If a fuse has blown, the element inside the fuse will be melted.

If the electrical system does not work, first check the driver's side fuse panel.

Always replace a blown fuse with one of the same rating.

If the replacement fuse blows, this indicates an electrical problem. Avoid using the system involved and immediately consult an Authorized Kia Dealer.

Three kinds of fuses are used: blade type for lower amperage rating and cartridge type, fusible link for higher amperage ratings.

Fuse replacement

⚠ WARNING - Fuse replacement

- Never replace a fuse with anything but another fuse of the same rating.
- A higher capacity fuse could cause damage possibly a fire.
- Never install a wire instead of the proper fuse - even as a temporary repair. It may cause extensive wiring damage and possibly a fire.

⚠ CAUTION

Do not use a screwdriver or any other metal object to remove fuses because it may cause a short circuit and damage the system.



CAUTION
 After checking the fuse box in the engine compartment, securely install the fuse box cover. If not, electrical failures may occur from water leaking in.

Engine compartment

1. Turn the ignition switch and all other switches off.
 2. Remove the fuse box cover by pressing the tap and pulling up.
 3. Check the removed fuse; replace it if it is blown. To remove or insert the fuse, use the fuse puller in the main fuse box in the engine compartment.
 4. Push in a new fuse of the same rating, and make sure it fits tightly in the clips.
- If it fits loosely, consult an Authorized Kia Dealer.

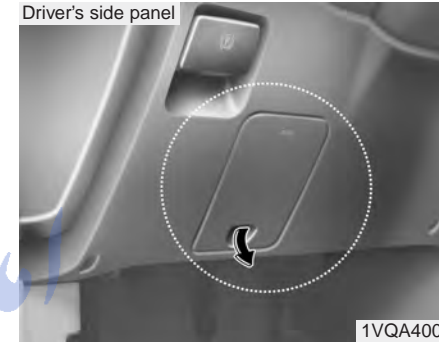

Inner panel

1. Turn the ignition switch and all other switches off.
2. Open the fuse panel cover.

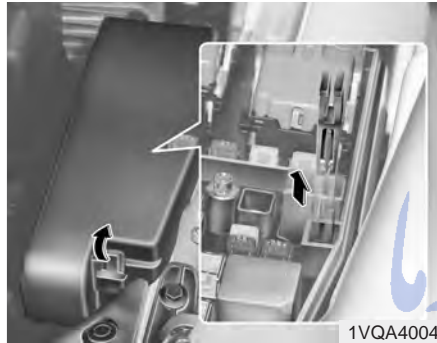

If the headlights or other electrical components do not work and the fuses are OK, check the fuse block in the engine compartment. If a fuse is blown, it must be replaced.

3. Pull the suspected fuse straight out. Use the removal tool provided on the main fuse box in the engine compartment.
4. Check the removed fuse; replace it if it is blown.

Spare fuses are provided in the main fuse box in the engine compartment.

5. Push in a new fuse of the same rating, and make sure it fits tightly in the clips. If it fits loosely, consult an Authorized Kia Dealer.

If you do not have a spare, use a fuse of the same rating from a circuit you may not need for operating the vehicle, such as the cigar lighter fuse.

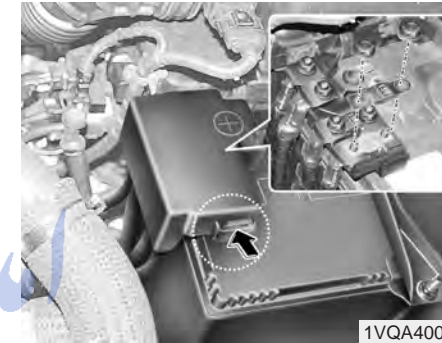

Main fuse

If the main fuse is blown, it must be removed as follows:

1. Disconnect the negative battery cable.
2. Remove the nuts shown in the picture above.
3. Replace the fuse with a new one of the same rating.
4. Reinstall in the reverse order of removal.

*** NOTICE**

If the main fuse is blown, consult an Authorized Kia Dealer.

Fuse/Relay panel description

Inside the fuse/relay box covers, you can find the fuse/relay label describing fuse/relay name and capacity.

Driver's side panel



Engine compartment

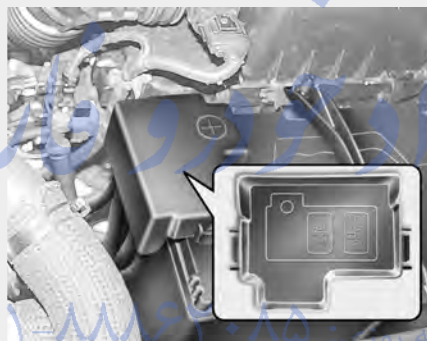

Rear cargo area panel



OVA067012/OVQ067017N/OVQ067104N/OVQ046010N

Maintenance

Driver's side fuse panel

Description	Fuse rating	Protected component
AUDIO	15A	Audio, Step lamp
MEMORY	7.5A	Climate control module, Clock, Cluster, Trip computer, Front area module, Power sliding door module, Power tailgate module, Driver's door module, Front passenger door module, Driver's power seat module, Driver position memory system unit
VRS	10A	Variable rack stroke system module, Variable rack stroke system control button
IG2-1	7.5A	Air conditioner control module, Multi function switch, Inside relay box, ECM mirror, Rain sensor, Seat Warmer
IG2-2	7.5A	Rear climate control button, Front area module, Power sliding door module, Power tailgate module, Driver's door module, Front passenger door module, Driver's power seat module, Driver position memory system unit
OBD-II	7.5A	OBD-II, Diagonosis connector
ROOM	7.5A	Vanity mirror, Map lamp, Overhead console, Room lamp switch, Climate control module, Homelink
K/LOCK	7.5A	Key interlock solenoid
ILLUMI	7.5A	Instrument panel illumination
AMP	25A	Amplifier
SEAT WARMER	20A	Inside relay box(Seat warmer)
SUNROOF	25A	Sunroof module
DDM	30A	Driver's door module
TPMS	7.5A	Tire pressure monitoring system
PEDAL	15A	Power adjustable pedal relay(Non-driver position memory system only)
P/OUTLET 1	15A	Power outlet(Front)
ASS P/SEAT	20A	Front passenger's power seat module
DRV P/SEAT	30A	Driver's power seat module
ADM	30A	Front passenger door module
ACC	7.5A	Audio, Clock, Outside rearview mirror control and folding switch
P/OUTLET 2	15A	Cigar lighter, Power outlet
START	7.5A	Start relay
AIRBAG IND	7.5A	Cluster

Description	Fuse rating	Protected component
ENG	7.5A	Automatic shift lever switch, Vehicle speed sensor, Inhibitor switch, Transaxle control module, Input speed sensor, Output speed sensor, Back-up lamp switch, Fuel filter
IG1	7.5A	Trip computer, Buzzer(Back warning system), Cluster, ESC switch, Ambient temperature sensor, Generator
ABS	7.5A	ABS control module, ESC control module, Yaw rate sensor, Steering angle sensor
AIRBAG	15A	Air bag control module
ALTERNATOR	-	Generator relay
SHUNT	-	Shunt connector

Rear cargo area panel

Description	Fuse rating	Protected component
RR D/LOCK	20A	Sliding door lock relay, Sliding door unlock relay, Sliding door lock actuator, Tailgate lock actuator
RR WIPER	15A	Rear wiper relay, Rear wiper motor
RR DEFOG	25A	Rear window defroster relay, Rear window defroster
POWER TAIL GATE	30A	Power tailgate module
P/QUARTER	10A	Power rear quarter glass open relay, Power rear quarter glass close relay, Power rear quarter glass motor
RR P/WIN-RH	25A	Sliding door power window relay(Right), Sliding door power window motor(Right)
RR P/WIN-LH	25A	Sliding door power window relay(Left), Sliding door power window motor(Left)
PSD-RH	30A	Power sliding door module(Right)
PSD-LH	30A	Power sliding door module(Left)
LUGGAGE	7.5A	Step lamp, Power tailgate ON/OFF switch, Tailgate lamp
FUEL DOOR	15A	Fuel filler lid relay, Fuel filler lid actuator
RR P/OTLT-LH	15A	Rear power outlet(Left)
RR P/OTLT-RH	15A	Rear power outlet(Right)
RR DEFOG RELAY	-	Rear window defroster relay

Maintenance

Engine compartment

Description	Fuse rating	Protected component
FRT/RR WASHER	10A	Front washer motor relay, Rear washer motor relay
IG 2	7.5A	AQS sensor, fuel filter
STOP LAMP	20A	Stop lamp, High mounted stop lamp
FUEL HEATER	20A	Fuel filter heater
KEY SW 1	25A	Instrument panel module
STOP SIGNAL	7.5A	TCU, PCU/ECU, ABS/ESC Unit
A/C COMP	7.5A	Air conditioner compressor relay
ATM	15A	ATM solenoid
FRT DEICER	15A	Front deicer
HORN	15A	Horn relay
ECU 1	10A	PCU/ECU, A/C comp relay, Mass air flow sensor, Immobilizer unit
O2 DN	10A	O2 sensor(RL, RR)
ECU 2	15A	PCU/ECU, Oil control valve 1/2, Variable intake manifold valve 1/2, Canister purge solenoid valve, Canister close valve, Pulse width modulation relay
O2 UP	10A	O2 sensor(FL, FR)
IGN COIL	20A	Ignition coil 1/2/3/4/5/6, Condensor
INJECTOR	15A	PCU/ECU, Injector 1/2/3/4/5/6, Glow relay 1/2, Intake manifold valve, EGR Solenoid valve, Cooling fan relay, Air flow sensor, Intake throttle valve

Description	Fuse rating	Protected component
P/TRAIN	7.5A	Theft alarm relay, Main relay, TCM, Generator, ECM, Injector 15A, ECU 2 15A, ECU 1 10A, Air conditioner compressor relay, Inlet metering valve, EGR sole- noid valve, Air flow sensor, Diesel box, Immobilizer module
FUEL PUMP	15A	Fuel pump motor
SP	7.5A	Spare fuse
SP	10A	Spare fuse
SP	15A	Spare fuse
SP	20A	Spare fuse
SP	25A	Spare fuse
ABS 1	40A	ABS control module, ESC control module
ABS 2	20A	ABS control module, ESC control module
FRT WIPER	30A	Front wiper ON relay
KEY SW 2	30A	Start relay, IG2 Load(Variable rack stroke, ECM mirror, Rain sensor, Seat warmer)
RAM 1	50A	Rear area module
RAM 2	50A	Rear area module
RAM 3	50A	Rear area module

Description	Fuse rating	Protected component
IPM 1	50A	Instrument panel module
IPM 2	50A	Instrument panel module
IPM 3	50A	Instrument panel module
FRT BLOWER	40A	Inside relay box(Front blower relay)
RR BLOWER	30A	Inside relay box(Rear blower relay)
IG 2 RELAY	-	Ignition relay
A/C COMP RELAY	-	Air conditioner compressor relay
MAIN RELAY	-	Main relay
START RELAY	-	Start relay
FUEL PUMP RELAY	-	Fuel pump relay

Engine compartment (main fuse)

Description	Fuse rating	Protected component
ALT	150A	Generator
C/FAN	60A	Cooling fan

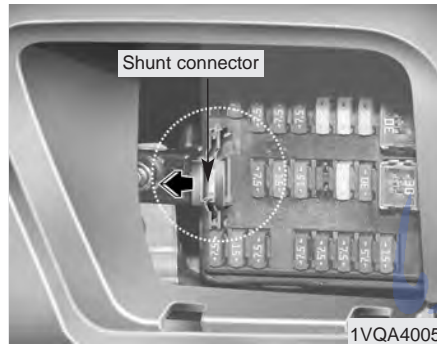

Shunt connector

Your vehicle is equipped with a shunt connector to prevent battery discharge if your vehicle is parked without being operated for prolonged periods. Use the following procedures before parking the vehicle for prolonged periods.

1. Turn off the engine.
2. Turn off the headlights and tail lights.
3. Open the driver's side panel cover and pull up the shunt connector.

* NOTICE

- If the shunt connector is pulled up from the fuse panel, the warning chime, audio, clock and interior lamps, etc., will not operate. Some items must be reset after replacement. (Refer to "Items to be reset..." on page 6-30)
- Even though the shunt connector is pulled up, the battery can still be discharged by operation of the headlights or other electrical devices.

BATTERY

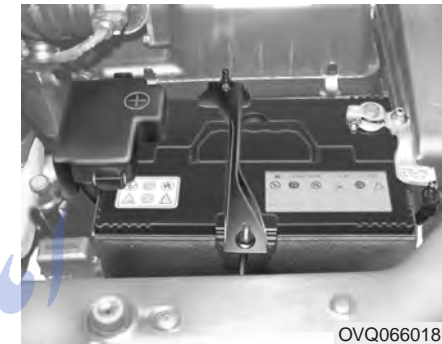

⚠ WARNING - Battery dangers

-  Always read the following instructions carefully when handling a battery.
-  Keep lighted cigarettes and all other flames or sparks away from the battery.
-  Hydrogen, a highly combustible gas, is always present in battery cells and may explode if ignited.

(Continued)

(Continued)



Keep batteries out of the reach of children because batteries contain highly corrosive SULFURIC ACID. Do not allow battery acid to contact your skin, eyes, clothing or paint finish.



If any electrolyte gets into your eyes, flush your eyes with clean water for at least 15 minutes and get immediate medical attention. If possible, continue to apply water with a sponge or cloth until medical attention is received. If electrolyte gets on your skin, thoroughly wash the contacted area. If you feel a pain or a burning sensation, get medical attention immediately.



Wear eye protection when charging or working near a battery. Always provide ventilation when working in an enclosed space.

(Continued)

(Continued)

- When lifting a plastic-cased battery, excessive pressure on the case may cause battery acid to leak, resulting in personal injury. Lift with a battery carrier or with your hands on opposite corners.
- Never attempt to recharge the battery when the battery cables are connected.
- The electrical ignition system works with high voltage. Never touch these components with the engine running or the ignition switched on.

Failure to follow the above warnings can result in serious bodily injury or death.

For best battery service:

- Keep the battery securely mounted.
- Keep the battery top clean and dry.
- Keep the terminals and connections clean, tight, and coated with petroleum jelly or terminal grease.
- Rinse any spilled electrolyte from the battery immediately with a solution of water and baking soda.
- If the vehicle is not going to be used for an extended time, disconnect the battery cables.

Battery recharging

Your vehicle has a maintenance-free, calcium-based battery.

- If the battery becomes discharged in a short time (because, for example, the headlights or interior lights were left on while the vehicle was not in use), recharge it by slow charging (trickle) for 10 hours.
- If the battery gradually discharges because of high electric load while the vehicle is being used, recharge it at 20-30A for two hours.

Items to be reset after the battery has been discharged or the battery has been disconnected.

- Clock (See Chapter 3)
- Sunroof (See Chapter 3)
- Trip computer (See Chapter 3)
- Climate control system (See Chapter 3)
- Audio (See Chapter 3)
- Power sliding door and power tailgate (See Chapter 3)

⚠ WARNING - Recharging battery

When recharging the battery, observe the following precautions:

- The battery must be removed from the vehicle and placed in an area with good ventilation.
- Do not allow cigarettes, sparks, or flame near the battery.
- Watch the battery during charging, and stop or reduce the charging rate if the battery cells begin gassing (boiling) violently or if the temperature of the electrolyte of any cell exceeds 49°C (120°F).

(Continued)

(Continued)

- Wear eye protection when checking the battery during charging.
- Disconnect the battery charger in the following order.
 1. Turn off the battery charger main switch.
 2. Unhook the negative clamp from the negative battery terminal.
 3. Unhook the positive clamp from the positive battery terminal.

⚠ CAUTION

- Before performing maintenance or recharging the battery, turn off all accessories and stop the engine.
- The negative battery cable must be removed first and installed last when the battery is disconnected.

TIRES AND WHEELS

Tire care

For proper maintenance, safety, and maximum fuel economy, you must always maintain recommended tire inflation pressures and stay within the load limits and weight distribution recommended for your vehicle.

Recommended cold tire inflation pressures

All tire pressures (including the spare) should be checked every day when the tires are cold. "Cold Tires" means the vehicle has not been driven for at least three hours or driven less than 1.6 km (one mile).

Recommended pressures must be maintained for the best ride, top vehicle handling, and minimum tire wear.



OVQ066022N

All specifications (sizes and pressures) can be found on a label attached to the vehicle.

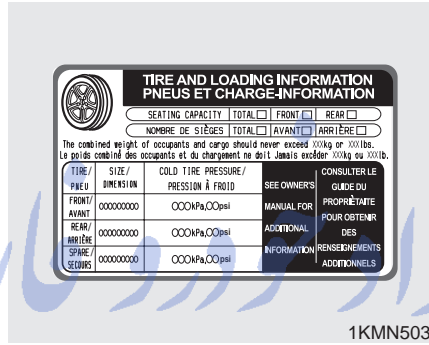

1KMN5039

⚠ WARNING - Tire underinflation

Severe underinflation (70 kPa (10 psi) or more) can lead to severe heat build-up, causing blowouts, tread separation and other tire failures that can result in the loss of vehicle control leading to severe injury or death. This risk is much higher on hot days and when driving for protracted periods at high speeds.

⚡ CAUTION

- Underinflation also results in excessive wear, poor handling and reduced fuel economy. Wheel deformation also is possible. Keep your tire pressures at the proper levels. If a tire frequently needs refilling, have it checked by an Authorized Kia Dealer.
- Overinflation produces a harsh ride, excessive wear at the center of the tire tread, and a greater possibility of damage from road hazards.

⚠ CAUTION

- *Warm tires normally exceed recommended cold tire pressures by 28 to 41 kPa (4 to 6 psi). Do not release air from warm tires to adjust the pressure or the tires will be under-inflated.*
- *Be sure to reinstall the tire inflation valve caps. Without the valve cap, dirt or moisture could get into the valve core and cause air leakage. If a valve cap is missing, install a new one as soon as possible.*

⚠ WARNING - Tire Inflation
Overinflation or underinflation can reduce tire life, adversely affect vehicle handling, and lead to sudden tire failure. This could result in loss of vehicle control and potential injury.

⚠ CAUTION - Tire pressure

Always observe the following:

- *Check tire pressure when the tires are cold. (After vehicle has been parked for at least three hours or hasn't been driven more than 1.6 km (one mile) since startup.)*
- *Check the pressure of your spare tire each time you check the pressure of other tires.*
- *Never overload your vehicle. Be careful not to overload a vehicle luggage rack if your vehicle is equipped with one.*
- *Worn, old tires can cause accidents. If your tread is badly worn, or if your tires have been damaged, replace them.*

Checking tire inflation pressure

Check your tires once a month or more.
Also, check the tire pressure of the spare tire.

How to check

Use a good quality gage to check tire pressure. You can not tell if your tires are properly inflated simply by looking at them. Radial tires may look properly inflated even when they're underinflated.

Check the tire's inflation pressure when the tires are cold. - "Cold" means your vehicle has been sitting for at least three hours or driven no more than 1.6 km (1 mile).

Remove the valve cap from the tire valve stem. Press the tire gage firmly onto the valve to get a pressure measurement. If the cold tire inflation pressure matches the recommended pressure on the tire and loading information label, no further adjustment is necessary. If the pressure is low, add air until you reach the recommended amount.

If you overfill the tire, release air by pushing on the metal stem in the center of the tire valve. Recheck the tire pressure with the tire gage. Be sure to put the valve caps back on the valve stems. They help prevent leaks by keeping out dirt and moisture.

Tire rotation

To equalize tread wear, it is recommended that the tires be rotated every 12,000 km (7,500 miles) or sooner if irregular wear develops.

During rotation, check the tires for correct balance.

When rotating tires, check for uneven wear and damage. Abnormal wear is usually caused by incorrect tire pressure, improper wheel alignment, out-of-balance wheels, severe braking or severe cornering. Look for bumps or bulges in the tread or side of tire. Replace the tire if you find either of these conditions. Replace the tire if fabric or cord is visible. After rotation, be sure to bring the front and rear tire pressures to specification and check lug nut tightness.

Refer to Section 7, Specifications.

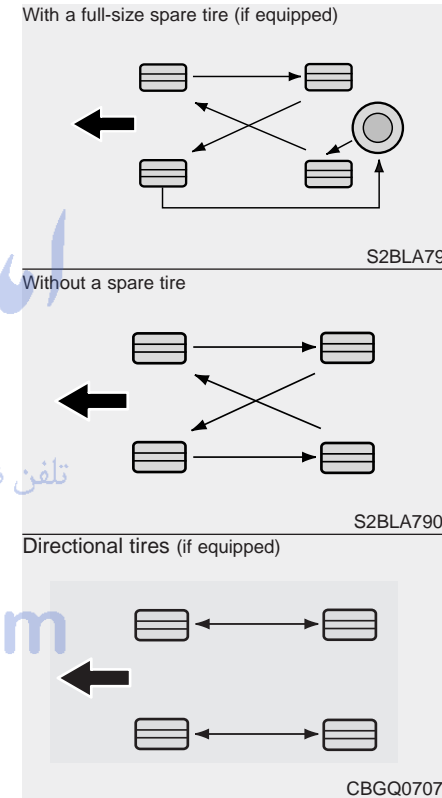

Disc brake pads should be inspected for wear whenever tires are rotated.

Rotate radial tires that have an asymmetric tread pattern only from front to rear and not from right to left.

⚠ WARNING

- Do not use the compact spare tire for tire rotation
- Do not mix bias ply and radial ply tires under any circumstances. This may cause unusual handling characteristics that could result in death, severe injury, or property damage.



Tire replacement

If the tire is worn evenly, a tread wear indicator will appear as a solid band across the tread. This shows there is less than 1.6 mm (1/16 inch) of tread left on the tire. Replace the tire when this happens.

Do not wait for the band to appear across the entire tread before replacing the tire.

Compact spare tire replacement

A compact spare tire has a shorter tread life than a regular size tire. Replace it when you can see the tread wear indicator bars on the tire. The replacement compact spare tire should be the same size and design tire as the one provided with your new Kia and should be mounted on the same compact spare tire wheel. The compact spare tire is not designed to be mounted on a regular size wheel, and the compact spare tire wheel is not designed for mounting a regular size tire.

Wheel replacement

When replacing the metal wheels for any reason, make sure the new wheels are equivalent to the original factory units in diameter, rim width and offset.

⚠ WARNING

A wheel that is not the correct size may adversely affect wheel and bearing life, braking and stopping abilities, handling characteristics, ground clearance, body-to-tire clearance, snow chain clearance, speedometer calibration, headlight aim and bumper height.

Wheel alignment and tire balance

The wheels on your vehicle were aligned and balanced carefully at the factory to give you the longest tire life and best overall performance.

In most cases, you will not need to have your wheels aligned again. However, if you notice unusual tire wear or your vehicle pulling one way or the other, the alignment may need to be reset.

If you notice your vehicle vibrating when driving on a smooth road, your wheels may need to be rebalanced.

⚠ CAUTION

Improper wheel weights can damage your vehicle's aluminum wheels. Use only approved wheel weights.

⚠ WARNING - Replacing tires

- Driving on worn-out tires is very hazardous and will reduce braking effectiveness, steering accuracy, and traction.
- Your vehicle is equipped with tires designed to provide for safe ride and handling capability. Do not use a size and type of tire and wheel that is different from the one that is originally installed on your vehicle. It can affect the safety and performance of your vehicle, which could lead to handling failure or rollover and serious injury.

(Continued)

(Continued)

When replacing the tires, be sure to equip all four tires with the tire and wheel of the same size, type, tread, brand and load-carrying capacity.

- The use of any other tire size or type may seriously affect ride, handling, ground clearance, stopping distance, body to tire clearance, snow tire clearance, and speedometer reliability.
- It is best to replace all four tires at the same time. If that is not possible, or necessary, then replace the two front or two rear tires as a pair. Replacing just one tire can seriously affect your vehicle's handling.

Tire traction

Tire traction can be reduced if you drive on worn tires, tires that are improperly inflated or on slippery road surfaces. Tires should be replaced when tread wear indicators appear. To reduce the possibility of losing control, slow down whenever there is rain, snow or ice on the road.

Tire maintenance

In addition to proper inflation, correct wheel alignment helps to decrease tire wear. If you find a tire is worn unevenly, have your dealer check the wheel alignment.

When you have new tires installed, make sure they are balanced. This will increase vehicle ride comfort and tire life. Additionally, a tire should always be rebalanced if it is removed from the wheel.

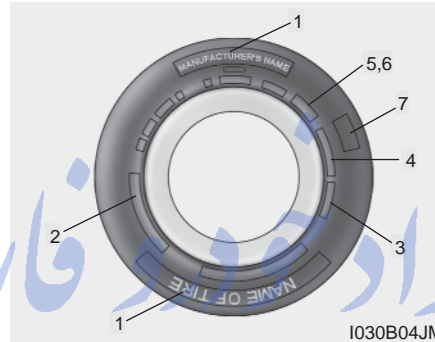

Tire sidewall labeling

Federal law requires tire manufacturers to place standardized information on the sidewall of all tires. This information identifies and describes the fundamental characteristics of the tire and also provides the tire identification number (TIN) for safety standard certification. The TIN can be used to identify the tire in case of a recall.

1. Manufacturer or brand name

Manufacturer or Brand name is shown.

2. Tire size designation

A tire's sidewall is marked with a tire size designation. You will need this information when selecting replacement tires for your car. The following explains what the letters and numbers in the tire size designation mean.

Example tire size designation:

(These numbers are provided as an example only; your tire size designator could vary depending on your vehicle.)

P185/65R14 86H

P - Applicable vehicle type (tires marked with the prefix "P" are intended for use on passenger cars or light trucks; however, not all tires have this marking).

185 - Tire width in millimeters.

65 - Aspect ratio. The tire's section height as a percentage of its width.

R - Tire construction code (Radial).

14 - Rim diameter in inches.

86 - Load Index, a numerical code associated with the maximum load the tire can carry.

H - Speed Rating Symbol. See the speed rating chart in this section for additional information.

Wheel size designation

Wheels are also marked with important information that you need if you ever have to replace one. The following explains what the letters and numbers in the wheel size designation mean.

Example wheel size designation:

5.5JX14

5.5 - Rim width in inches.

J - Rim contour designation.

14 - Rim diameter in inches.

Tire speed ratings

The chart below lists many of the different speed ratings currently being used for passenger cars. The speed rating is part of the tire size designation on the sidewall of the tire. This symbol corresponds to that tire's designed maximum safe operating speed.

Speed Rating Symbol	Maximum Speed
S	180 km/h (112 mph)
T	190 km/h (118 mph)
H	210 km/h (130 mph)
V	240 km/h (149 mph)
Z	Above 240 km/h (149 mph)

3. Checking tire life (TIN : Tire Identification Number)

Any tires that are over 6 years, based on the manufacturing date, tire strength and performance, decline with age naturally (even unused spare tires). Therefore, the tires (including the spare tire) should be replaced by new ones. You can find the manufacturing date on the tire sidewall (possibly on the inside of the wheel), displaying the DOT Code. The DOT Code is a series of numbers on a tire consisting of numbers and English letters. The manufacturing date is designated by the last four digits (characters) of the DOT code.

DOT : XXXX XXXX OOOO

The front part of the DOT means a plant code number, tire size and tread pattern and the last four numbers indicate week and year manufactured.

For example:

DOT XXXX XXXX 1605 represents that the tire was produced in the 16th week of 2005.

⚠ WARNING - Tire age
Tires degrade over time, even when they are not being used. Regardless of the remaining tread, it is recommended that tires generally be replaced after six (6) years of normal service. Heat caused by hot climates or frequent high loading conditions can accelerate the aging process. Failure to follow this warning can result in sudden tire failure, which could lead to a loss of control and an accident involving serious injury or death.

4. Tire ply composition and material

The number of layers or plies of rubber-coated fabric in the tire. Tire manufacturers also must indicate the materials in the tire, which include steel, nylon, polyester, and others. The letter "R" means radial ply construction; the letter "D" means diagonal or bias ply construction; and the letter "B" means belted-bias ply construction.

5. Maximum permissible inflation pressure

This number is the greatest amount of air pressure that should be put in the tire. Do not exceed the maximum permissible inflation pressure. Refer to the Tire and Loading Information label for recommended inflation pressure.

6. Maximum load rating

This number indicates the maximum load in kilograms and pounds that can be carried by the tire. When replacing the tires on the vehicle, always use a tire that has the same load rating as the factory installed tire.

7. Uniform tire quality grading

The following information relates to the tire grading system developed by the Canadian Motor Vehicle Safety Standard (CMVSS) for grading tires by tread wear, traction and temperature performance.

Tread wear

The tread wear grade is a comparative rating based on the wear rate of the tire when tested under controlled conditions on a specified government test course. For example, a tire graded 150 would wear one-and-a-half times as well on the government course as a tire graded 100.

The relative performance of tires depends upon the actual conditions of their use. However, performance may differ from the norm because of variations in driving habits, service practices and differences in road characteristics and climate.

These grades are molded on the side-walls of passenger vehicle tires. The tires available as standard or optional equipment on Kia vehicles may vary with respect to grade.

Traction - AA, A, B & C

The traction grades, from highest to lowest, are AA, A, B and C. The grades represent the tires ability to stop on wet pavement as measured under controlled conditions on specified government test surfaces of asphalt and concrete. A tire marked C may have poor traction performance.

Temperature -A, B & C

The temperature grades are A (the highest), B and C. The grades represent the tire's resistance to the generation of heat and its ability to dissipate heat when tested under controlled conditions on a specified indoor laboratory test wheel.

Sustained high temperature can cause the material of the tires to degenerate and reduce tires life, and excessive temperature can lead to sudden tires failure. Grades A and B represent higher levels of performance on the laboratory test wheel than the minimum required by the law.

⚠ WARNING - Tire temperature

The temperature grade for this tire is established for a tire that is properly inflated and not overloaded. Excessive speed, underinflation, or excessive loading, either separately or in combination, can cause heat build-up and possible sudden tire failure. This can cause loss of vehicle control and serious injury or death.

Tire terminology and definitions

Air Pressure: The amount of air inside the tire pressing outward on the tire. Air pressure is expressed in kilopascal (kPa) or pounds per square inch (psi).

Accessory Weight: This means the combined weight of optional accessories. Some examples of optional accessories are, automatic transmission, power seats, and air conditioning.

Aspect Ratio: The relationship of a tire's height to its width.

Belt: A rubber coated layer of cords that is located between the plies and the tread. Cords may be made from steel or other reinforcing materials.

Bead: The tire bead contains steel wires wrapped by steel cords that hold the tire onto the rim.

Bias Ply Tire: A pneumatic tire in which the plies are laid at alternate angles less than 90 degrees to the centerline of the tread.

Cold Tire Pressure: The amount of air pressure in a tire, measured in kilopascals (kPa) or pounds per square inch (psi) before a tire has built up heat from driving.

Curb Weight: This means the weight of a motor vehicle with standard and optional equipment including the maximum capacity of fuel, oil and coolant, but without passengers and cargo.

DOT Markings: The DOT code includes the Tire Identification Number (TIN), an alphanumeric designator which can also identify the tire manufacturer, production plant, brand and date of production.

GVWR: Gross Vehicle Weight Rating

GAWR FRT: Gross Axle Weight Rating for the front Axle.

GAWR RR: Gross Axle Weight Rating for the rear axle.

Intended Outboard Sidewall: The side of an asymmetrical tire, that must always face outward when mounted on a vehicle.

Kilopascal (kPa): The metric unit for air pressure.

Load Index: An assigned number ranging from 1 to 279 that corresponds to the load carrying capacity of a tire.

Maximum Inflation Pressure: The maximum air pressure to which a cold tire may be inflated. The maximum air pressure is molded onto the sidewall.

Maximum Load Rating: The load rating for a tire at the maximum permissible inflation pressure for that tire.

Maximum Loaded Vehicle Weight: The sum of curb weight; accessory weight; vehicle capacity weight; and production options weight.

Normal Occupant Weight: The number of occupants a vehicle is designed to seat multiplied by 68 kg (150 pounds).

Occupant Distribution: Designated seating positions.

Outward Facing Sidewall: The side of a asymmetrical tire that has a particular side that faces outward when mounted on a vehicle. The outward facing sidewall bears white lettering or bears manufacturer, brand, and/or model name molding that is higher or deeper than the same moldings on the inner facing sidewall.

Passenger (P-Metric) Tire: A tire used on passenger cars and some light duty trucks and multipurpose vehicles.

Recommended Inflation Pressure: Vehicle manufacturer's recommended tire inflation pressure and shown on the tire placard.

Radial Ply tire: A pneumatic tire in which the ply cords that extend to the beads are laid at 90 degrees to the centerline of the tread.

Rim: A metal support for a tire and upon which the tire beads are seated.

Sidewall: The portion of a tire between the tread and the bead.

Speed Rating: An alphanumeric code assigned to a tire indicating the maximum speed at which a tire can operate.

Traction: The friction between the tire and the road surface. The amount of grip provided.

Tread: The portion of a tire that comes into contact with the road.

Treadwear Indicators: Narrow bands, sometimes called "wear bars," that show across the tread of a tire when only 2/32 inch of tread remains.

UTQGS: Uniform Tire Quality Grading Standards, a tire information system that provides consumers with ratings for a tire's traction, temperature and treadwear. Ratings are determined by tire manufacturers using government testing procedures. The ratings are molded into the sidewall of the tire.

Vehicle Capacity Weight: The number of designated seating positions multiplied by 68 kg (150 lbs.) plus the rated cargo and luggage load.

Vehicle Maximum Load on the Tire: Load on an individual tire due to curb and accessory weight plus maximum occupant and cargo weight.

Vehicle Normal Load on the Tire: That load on an individual tire that is determined by distributing to each axle its share of the curb weight, accessory weight, and normal occupant weight and driving by 2.

Vehicle Placard: A label permanently attached to a vehicle showing the original equipment tire size and recommended inflation pressure.

All season tires

Kia specifies all season tires on some models to provide good performance for use all year round, including snowy and icy road conditions. All season tires are identified by ALL SEASON and/or M+S (Mud and Snow) on the tire sidewall. Snow tires have better snow traction than all season tires and may be more appropriate in some areas.

Summer tires

Kia specifies summer tires on some models to provide superior performance on dry roads. Summer tire performance is substantially reduced in snow and ice. Summer tires do not have the tire traction rating M+S (Mud and Snow) on the tire side wall. If you plan to operate your vehicle in snowy or icy conditions, Kia recommends the use of snow tires or all season tires on all four wheels.

Snow tires

If you equip your car with snow tires, they should be the same size and have the same load capacity as the original tires. Snow tires should be installed on all four wheels; otherwise, poor handling may result.

Snow tires should carry 28 kPa (4 psi) more air pressure than the pressure recommended for the standard tires on the tire label on the driver's side of the center pillar, or up to the maximum pressure shown on the tire sidewall, whichever is less.

Do not drive faster than 120 km/h (75 mph) when your car is equipped with snow tires.

LUBRICANT

Recommended lubricants

To help achieve proper engine and powertrain performance and durability, use only lubricants of the proper quality. The correct lubricants also help promote engine efficiency that results in improved fuel economy.

Engine oils labeled Energy Conserving Oil are now available. Along with other additional benefits, they contribute to fuel economy by reducing the amount of fuel necessary to overcome engine friction. Often, these improvements are difficult to measure in everyday driving, but in a year's time, they can offer significant cost and energy savings.

These lubricants and fluids are recommended for use in your vehicle.

Lubricant	Classification
Engine oil *1	API Service SJ, SL or above, ILSAC GF-3 or above
Automatic transaxle fluid	DIAMOND ATF SP-III or SK ATF SP-III
Power steering fluid	PSF-III
Brake fluid	FMVSS116 DOT-3 or DOT-4

*1 Refer to the recommended SAE viscosity numbers.

Recommended SAE viscosity number

CAUTION

Always be sure to clean the area around any filler plug, drain plug, or dipstick before checking or draining any lubricant. This is especially important in dusty or sandy areas and when the vehicle is used on unpaved roads. Cleaning the plug and dipstick areas will prevent dirt and grit from entering the engine and other mechanisms that could be damaged.

Engine oil viscosity (thickness) has an effect on fuel economy and cold weather operating (starting and oil flow). Lower viscosity engine oils can provide better fuel economy and cold weather performance, however, higher viscosity engine oils are required for satisfactory lubrication in hot weather. Using oils of any viscosity other than those recommended could result in engine damage.

When choosing an oil, consider the range of temperature your vehicle will be operated in before the next oil change. Proceed to select the recommended oil viscosity from the chart.

Temperature Range for SAE Viscosity Numbers	
Temperature	°C -30 -20 -10 0 10 20 30 40 50
	(°F) -10 0 20 40 60 80 100 120
Engine Oil *1	10W-30
	5W-20, 5W-30

1. For better fuel economy, it is recommended to use the engine oil of a viscosity grade SAE 5W-20, 5W-30 (API SJ, SL / ILSAC GF-3). However, if the engine oil is not available in your country, select the proper engine oil using the engine oil viscosity chart.

APPEARANCE CARE

Exterior care

Exterior general caution

It is very important to follow the label directions when using any chemical cleaner or polish. Read all warning and caution statements that appear on the label.

Finish maintenance

Washing

To help protect your vehicle's finish from rust and deterioration, wash it thoroughly and frequently at least once a month with lukewarm or cold water.

If you use your vehicle for off-road driving, you should wash it after each off-road trip. Pay special attention to the removal of any accumulation of salt, dirt, mud, and other foreign materials. Make sure the drain holes in the lower edges of the doors and rocker panels are kept clear and clean.

Insects, tar, tree sap, bird droppings, industrial pollution and similar deposits can damage your vehicle's finish if not removed immediately.

Even prompt washing with plain water may not completely remove all these deposits. A mild soap, safe for use on painted surfaces, may be used.

After washing, rinse the vehicle thoroughly with lukewarm or cold water. Do not allow soap to dry on the finish.

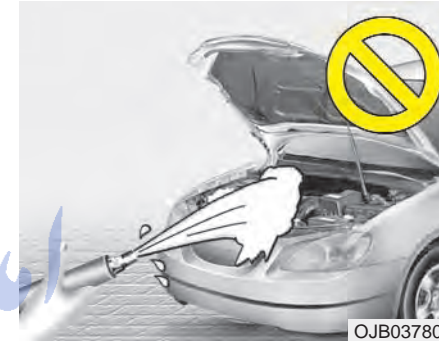

OJB037800

CAUTION

Do not use strong soap, chemical detergents or hot water, and do not wash the vehicle in direct sunlight or when the body of the vehicle is warm.

WARNING - Wet brakes

After washing the vehicle, test the brakes while driving slowly to see if they have been affected by water. If braking performance is impaired, dry the brakes by applying them lightly while maintaining a slow forward speed.

CAUTION

- *Water washing in the engine compartment including high pressure water washing may cause the failure of electrical circuits located in the engine compartment.*
- *Never allow water or other liquids to come in contact with electrical/electronic components inside the vehicle as this may damage them.*

Waxing

Wax the vehicle when water will no longer bead on the paint.

Always wash and dry the vehicle before waxing. Use a good quality liquid or paste wax, and follow the manufacturer's instructions. Wax all metal trim to protect it and to maintain its luster.

Removing oil, tar, and similar materials with a spot remover will usually strip the wax from the finish. Be sure to re-wax these areas even if the rest of the vehicle does not yet need waxing.

CAUTION

- *Wiping dust or dirt off the body with a dry cloth will scratch the finish.*
- *Do not use steel wool, abrasive cleaners, or strong detergents containing highly alkaline or caustic agents on chrome-plated or anodized aluminum parts. This may result in damage to the protective coating and cause discoloration or paint deterioration.*

Finish damage repair

Deep scratches or stone chips in the painted surface must be repaired promptly. Exposed metal will quickly rust and may develop into a major repair expense.

* NOTICE

If your vehicle is damaged and requires any metal repair or replacement, be sure the body shop applies anti-corrosion materials to the parts repaired or replaced.

Bright-metal maintenance

- To remove road tar and insects, use a tar remover, not a scraper or other sharp object.
- To protect the surfaces of bright-metal parts from corrosion, apply a coating of wax or chrome preservative and rub to a high luster.
- During winter weather or in coastal areas, cover the bright metal parts with a heavier coating of wax or preservative. If necessary, coat the parts with non-corrosive petroleum jelly or other protective compound.

Underbody maintenance

Corrosive materials used for ice and snow removal and dust control may collect on the underbody. If these materials are not removed, accelerated rusting can occur on underbody parts such as the fuel lines, frame, floor pan and exhaust system, even though they have been treated with rust protection.

Thoroughly flush the vehicle underbody and wheel openings with lukewarm or cold water once a month at the end of each winter. Pay special attention to these areas because it is difficult to see all the mud and dirt. It will do more harm than good to wet down the road grime without removing it. The lower edges of doors, rocker panels, and frame members have drain holes that should not be allowed to clog with dirt; trapped water in these areas can cause rusting.

WARNING

After washing the vehicle, test the brakes while driving slowly to see if they have been affected by water. If braking performance is impaired, dry the brakes by applying them lightly while maintaining a slow forward speed.

Aluminum wheel maintenance

The aluminum wheels are coated with a clear protective finish.

- Do not use any abrasive cleaner, polishing compound, solvent, or wire brushes on aluminum wheels. They may scratch or damage the finish.
- Use only a mild soap or neutral detergent, and rinse thoroughly with water. Also, be sure to clean the wheels after driving on salted roads. This helps prevent corrosion.
- Avoid washing the wheels with high-speed car wash brushes.
- Do not use any acid detergent. It may damage and corrode the aluminum wheels coated with a clear protective finish.

Interior care**Interior general precautions**

Prevent caustic solutions such as perfume and cosmetic oil from contacting the dashboard because they may cause damage or discoloration. If they do contact the dashboard, wipe them off immediately. See the instructions that follow for the proper way to clean vinyl.

CAUTION

Never allow water or other liquids to come in contact with electrical/electronic components inside the vehicle as this may damage them.

Cleaning the upholstery and interior trim**Vinyl**

Remove dust and loose dirt from vinyl with a whisk broom or vacuum cleaner. Clean vinyl surfaces with a vinyl cleaner.

Fabric

Remove dust and loose dirt from fabric with a whisk broom or vacuum cleaner. Clean with a mild soap solution recommended for upholstery or carpets. Remove fresh spots immediately with a fabric spot cleaner. If fresh spots do not receive immediate attention, the fabric can be stained and its color can be affected. Also, its fire-resistant properties can be reduced if the material is not properly maintained.

CAUTION

Using anything but recommended cleaners and procedures may affect the fabric's appearance and fire-resistant properties.

FarmaSOS.com

Cleaning the lap/shoulder belt webbing

Clean the belt webbing with any mild soap solution recommended for cleaning upholstery or carpet. Follow the instructions provided with the soap. Do not bleach or re-dye the webbing because this may weaken it.

Cleaning the interior window glass

If the interior glass surfaces of the vehicle become fogged (that is, covered with an oily, greasy or waxy film), they should be cleaned with glass cleaner. Follow the directions on the glass cleaner container.

CAUTION

Do not scrape or scratch the inside of the rear window. This may result in damage to the rear window defroster grid.

EMISSION CONTROL SYSTEM

The emission control system of your vehicle is covered by a written limited warranty. Please see the warranty information contained in the Warranty & Consumer Information Manual in your vehicle.

Vehicle modifications

This vehicle should not be modified. Modification of your Kia could affect its performance, safety or durability and may even violate governmental safety and emissions regulations.

In addition, damage or performance problems resulting from any modification may not be covered under warranty.

Engine exhaust gas precautions (carbon monoxide)

- Carbon monoxide can be present with other exhaust fumes. Therefore, if you smell exhaust fumes of any kind inside your vehicle, have it inspected and repaired immediately. If you ever suspect exhaust fumes are coming into your vehicle, drive it only with all the windows fully open. Have your vehicle checked and repaired immediately.

⚠ WARNING - Exhaust

Engine exhaust gases contain carbon monoxide (CO). Though colorless and odorless, it is dangerous and could be lethal if inhaled. Follow the instructions following to avoid CO poisoning.

- Do not operate the engine in confined or closed areas (such as garages) any more than what is necessary to move the vehicle in or out of the area.
- When the vehicle is stopped in an open area for more than a short time with the engine running, adjust the ventilation system (as needed) to draw outside air into the vehicle.
- Never sit in a parked or stopped vehicle for any extended time with the engine running.
- When the engine stalls or fails to start, excessive attempts to re-start the engine may cause damage to the emission control system.

Operating precautions for catalytic converters

⚠ WARNING - Fire

A hot exhaust system can ignite flammable items under your vehicle. Do not park the vehicle over or near flammable objects, such as grass, vegetation, paper, leaves, etc.

Your vehicle is equipped with a catalytic converter emission control device.

Therefore, the following precautions must be observed:

- Use only UNLEADED FUEL for gasoline engine.
- Do not operate the vehicle when there are signs of engine malfunction, such as misfire or a noticeable loss of performance.
- Do not misuse or abuse the engine. Examples of misuse are coasting with the ignition off and descending steep grades in gear with the ignition off.

- Do not operate the engine at high idle speed for extended periods (5 minutes or more).
- Do not modify or tamper with any part of the engine or emission control system. All inspections and adjustments must be made by an authorized Kia dealer.
- Avoid driving with a very low fuel level. If you run out of gasoline, it could cause the engine to misfire and result in excessive loading of the catalytic converter.

Failure to observe these precautions could result in damage to the catalytic converter and to your vehicle.

Additionally, such actions could void your warranties.

Dimensions / 7-2
Bulb wattage / 7-2
Tires / 7-3
Capacities / 7-3

امداد خودرو فارما

تلفن شبانه روزی: ۰۲۱-۸۸۸۶۲۰۸۵

Farma300.com

Specifications

7

Specifications

DIMENSIONS

Long wheelbase

Item	mm (in)
Overall length	5130 (202.0)
Overall width	1985 (78.1) ^{*1} / 1940 (76.4)
Overall height	1815 (71.5) ^{*2} / 1760 (69.3)
Front tread	1685 (66.3)
Rear tread	1685 (66.3)
Wheelbase	3020 (118.9)

Short wheelbase

Item	mm (in)
Overall length	4810 (189.4)
Overall width	1985 (78.1) ^{*1} / 1940 (76.4)
Overall height	1815 (71.5) ^{*2} / 1760 (69.3)
Front tread	1685 (66.3)
Rear tread	1685 (66.3)
Wheelbase	2890 (113.8)

^{*1} With door handle

^{*2} With roof rack

BULB WATTAGE

Light Bulb	Wattage
Headlights (Low)	55
Headlights (High)	55
Front turn signal/Position lights	28/8 (Amber)
Side mark lights	5
Front fog lights	35
Stop and tail lights	27/8
Rear turn signal lights	27 (Amber)
Back-up lights	16
High mounted stop light	LED ^{*1}
License plate lights	5
Front map lamps	10
Center dome lamps	10
Tailgate lamp	10
Door courtesy lamps	5
Glove box lamp	5
Vanity mirror lamps	3

^{*1} LED : Light-emitting diode

TIRES

Item	Tire size	Wheel size	Inflation pressure kPa (psi)		Wheel lug nut torque kg•m (N•m, lb•ft)
			Front	Rear	
Full size tire	225/70R16	6.5Jx16	240	240	9~11 (88~107, 65~79)
	235/60R17	6.5Jx17	(35)	(35)	
Compact spare tire	T135/90R17	4.0Tx17	420 (60)	420 (60)	

CAPACITIES

Lubricant	Volume	Classification
Engine oil ¹ (drain and refill)	5.2 l (5.49 US qt.)	API Service SJ, SL or above, ILSAC GF-3 or above (SAE 5W-20)
Automatic transaxle fluid	10.9 l (11.52 US qt.)	DIAMOND ATF SP-III, SK ATF SP-III
Power steering	1.0 l (1.06 US qt.)	PSF-III
Coolant	8.6 l (9.09 US qt.)	Ethylene glycol base for aluminum radiator
Brake fluid	0.7~0.8 l (0.7~0.8 US qt.)	FMVSS116 DOT-3 or DOT-4
Fuel	80 l (21.1 US gal.)	-

¹ Refer to the recommended SAE viscosity numbers on the page 6-42.

امداد خودرو فارما

تلفن شبانه روزی: ۰۲۱-۸۸۸۶۲۰۸۵

FarmaSOS.com

Index

A

- Air bags-advanced restraint system.....3-78
- Air cleaner6-13
- Antenna3-179
- Appearance care.....6-43
- Audio remote control.....3-179
- Audio system3-180
- Automatic climate control system.....3-147
- Automatic transaxle.....4-5, 6-13

B

- Battery.....6-28
- Before driving.....4-2
- Brake system.....4-14
- Brakes6-15
- Bulb wattage.....7-2

C

- Capacities.....7-3
- Child restraint system3-71
- Cruise control system4-11
- Climate control air filter6-17

D

- Defroster3-134
- Dimensions7-2

- Door locks.....3-11
- Driver position memory system3-57

E

- Economical operation4-25
- Electronic stability control.....4-19
- Emergency starting5-2
- Emission control system.....6-46
- Engine compartment6-9
- Engine coolant6-11
- Engine oil.....6-10

F

- Fuel filler lid3-30
- Fuel requirements1-2
- Fuses6-20

G

- Gauges3-109

H

- Hazard warning flasher3-135
- Homelink® wireless control system.....3-165
- Hood.....3-29
- Horn3-133
- How to use this manual1-2

I

If the engine overheats	5-5
If you have a flat tire	5-6
Immobilizer system	3-9
Instrument cluster	3-108
Instrument panel overview	2-3
Interior features	3-173
Interior lights	3-123
Interior overview	2-2

K

Key positions	4-3
Keys	3-3

L

Label information	4-35
Lighting	3-127
Lubricant	6-42
Lubricants and fluids	6-16
Luggage net holder	3-163

M

Maintenance schedule	6-3
Maintenance services	6-2
Manual climate control system	3-136
Mirrors	3-103

O

Overloading	4-34
Owner maintenance	6-7

P

Power adjustable pedals	3-58
Power sliding door and power tailgate	3-17
Power steering	6-17

R

Rear parking assist system	4-22
Rear seat entertainment system	3-210
Remote keyless entry	3-4
Road warning	5-2
Roof rack	3-164

S

Safety belts	3-59
Seat	3-37
Special driving conditions	4-26
Starting the engine	4-4
Steering wheel	3-101
Storage compartment	3-169
Sunroof	3-33

T

Theft-alarm system	3-7
--------------------------	-----

Index

Tires	7-3
Tires and wheels	6-30
Towing	5-15
Trailer towing	4-28
Trip computer.....	3-112

V

Vehicle break-in process	1-3
--------------------------------	-----

W

Warnings and indicators.....	3-118
Window	3-26
Windshield defrosting and defogging.....	3-160
Winter driving	4-28
Wiper blades	6-18
Wipers and washers	3-130

امداد خودرو فارما

تلفن شبانه روزی: ۰۸۵ ۲۰۸۸۶۲۰۲۱

FarmaSOS.com